



July 28, 2020

Judge KP George
Fort Bend County
301 Jackson St.
Richmond, TX 77469

RE: Easement to Fort Bend County to install a roadway across CenterPoint Energy Houston Electric, LLC's O'Brien – Allens Creek ROW; Job# 152917

Judge KP George:

Attached is the executed easement document. Please return a recorded copy along with a check in the amount of \$34,504.00, payable to CenterPoint Energy Houston Electric, LLC, to me at the address below. Once payment and a recorded copy is received, construction may begin on your project.

As specified in the Construction Specification, please notify the Company Representative seven (7) days prior to any construction activities and keep a copy of this instrument on site at all times.

If you have any questions, please contact me at 713-207-7938.

Regards,

A handwritten signature in cursive script that reads "Jasmine Brown".

Jasmine Brown
Right of Way Agent – Land Use
Land Management Division
CenterPoint Energy Houston Electric, LLC

Enclosures

By Mail:

CenterPoint Energy
P.O. Box 1700
Houston, Texas 77251-1700
Attn: Jasmine Brown CNPT 701C

By Courier:

CenterPoint Energy
1111 Louisiana
Houston, Texas 77002
Attn: Jasmine Brown CNPT 701C

ROADWAY EASEMENT

NOTICE OF CONFIDENTIALITY RIGHTS: IF YOU ARE A NATURAL PERSON, YOU MAY REMOVE OR STRIKE ANY OR ALL OF THE FOLLOWING INFORMATION FROM ANY INSTRUMENT THAT TRANSFERS AN INTEREST IN REAL PROPERTY BEFORE IT IS FILED FOR RECORD IN THE PUBLIC RECORDS: YOUR SOCIAL SECURITY NUMBER OR YOUR DRIVER'S LICENSE NUMBER.

STATE OF TEXAS §

 § **KNOW ALL PERSONS BY THESE PRESENTS:**

COUNTY OF FORT BEND§

GRANTOR: **CenterPoint Energy Houston Electric, LLC**, a Texas limited liability company, f/k/a Houston Lighting & Power Company

GRANTEE: **Fort Bend County, Texas**, a body corporate and politic of the State of Texas

CONSIDERATION: For Peek Road Parcel 4, the sum of Ten Dollars and No Cents (\$10.00) and other valuable consideration.

CONVEYANCE and PROPERTY DESCRIPTION: For the consideration stated above paid by the Grantee to the Grantor, the receipt and sufficiency of which is hereby acknowledged and confessed, the Grantor has GRANTED, SOLD, and CONVEYED, and does by these presents GRANT, SELL and CONVEY unto Grantee, its successors and assigns, a non exclusive easement for the purposes of the installation, use, construction, operation, inspection, repair, maintenance, replacement and removal of streets and roadways (consisting of all necessary equipment and appurtenances), roadway drainage and such other purposes and objects as Grantee may lawfully perform, the property, herein called "the Easement Area", described and illustrated on the metes and bounds and sketch description attached hereto, marked **EXHIBIT "A"**, and made a part hereof for all purposes, together with the right of reasonable working space not unreasonably detrimental to

Grantor's use of its adjoining property, and all other rights necessary to the full and complete use and enjoyment of the Easement Area.

APPLICABLE LAWS AND CODES: To the extent that such laws and codes apply to Grantee, its successors or assigns, Grantee or its successors or assigns, contractors and agents shall observe all safety codes and laws which apply to working along, within and or near the Easement Area and facilities during construction activities and safe clearance from such facilities, including O.S.H.A., Chapter 752 of the Texas Health and Safety Code, The National Electric Code, and the National Electrical Safety Code.

TERMS, CONDITIONS AND OBLIGATIONS: (1) This conveyance is subject to all restrictions, reservations, easements, pipelines, and encumbrances recorded in the Fort Bend County Clerk's Official Public Records of Real Property which affect the Easement Area, to the extent they are valid and subsisting and are enforceable against a political subdivision of the State of Texas; (2) Grantee shall not construct, or allow to be constructed, any bridge, traffic control signal or sign within the Easement Area without the written permission of Grantor; (3) Grantee further agrees not to place any vegetation or trees within the Easement Area and shall be solely responsible for any damages to Grantor's property and facilities (4) Grantee, its successors and assigns, shall install Grantee's facilities within the Easement Area herein granted. If, at a later date, any portion of Grantee's facilities are found to be outside of the Easement Area, then Grantee will, at its own cost and expense, relocate said Grantee's facilities to within the Easement Area herein granted; and (5) Grantee, its successors and assigns, assumes all costs resulting from any temporary or permanent alterations to or changes in the structure support arrangement and installation (including, but not limited to, temporary guying, strengthening of structures and additional ground line treating of poles due to the disturbing of the earth around the base of the poles) of any of Grantor's structures or improvements located near the Easement Area herein granted and made necessary by the construction, maintenance, operation, and removal of said Grantee's facilities or any use consistent with the purpose of this Easement Area by Grantee, its successors or assigns (6) Grantee shall require its contractors to guarantee all work performed by its contractors and subcontractors against any and all defects in

workmanship and to, at their sole cost and expense, make repairs as deemed necessary by Grantor to remedy such defects within fourteen (14) days after demand and, (7) Grantee, its contractors and subcontractors are forever subject to all terms, conditions and construction requirements set out in Grantor's Specification for Construction on CenterPoint Energy Property, as they apply to Grantee's Facilities upon Grantor's Property, a copy of which is attached hereto and made a part hereof as **EXHIBIT "B"**, and is hereinafter referred to as the "SPECIFICATIONS".

RESERVATIONS FROM CONVEYANCE: (1) Grantor reserves all of the oil, gas, and other minerals within or under the Easement Area, provided, however, that neither Grantor, nor any oil, gas, or mineral lessee claiming under Grantor, may drill or excavate for minerals on the surface of the Easement Area, but may extract oil, gas, and other minerals from the Easement Area by directional drilling or other means which do not interfere with or disturb Grantee's use of the surface of the Easement Area; (2) Except during emergency operations, Grantor retains reasonably unobstructed rights of ingress and egress to and from the Easement Area; and, (3) Grantor retains ownership of all of Grantor's facilities presently existing and all future facilities placed within the Easement Area.

FITNESS OF EASEMENT AREA: Grantor does not warrant, expressly or implicitly, the conditions of fitness of the Easement Area conveyed hereunder, any such warranty being hereby expressly negated. Grantee, by acceptance hereof, acknowledges by recording this document that it has, as a further inducement to Grantor, made a complete inspection of the Easement Area, including the environmental condition existing in, on, and under it and any improvements being conveyed hereby, and is in all respects satisfied therewith and fully accepts the Easement Area above, at grade and under, in a **where is as is condition.**

TO HAVE AND TO HOLD the said easement, unto the Grantee, and its successors and assigns, forever, and Grantor does hereby bind itself and its successors and assigns **TO WARRANT AND FOREVER DEFEND** all and singular the said premises unto Grantee, its successors and assigns, against every person whomsoever lawfully claiming or to claim

the same, or any part thereof.

Grantee shall be responsible for recording the easement and, upon receipt of the recorded instrument, shall deliver a copy to Grantor at the address below:

CenterPoint Energy Houston Electric, LLC
P.O. Box 1700
Houston, Texas 77251-1700
Attn: Matthew Dowell

IN WITNESS WHEREOF, these presents have been executed by Grantor this the _____ day of _____, 2020.

CENTERPOINT ENERGY HOUSTON ELECTRIC, LLC

By: _____
Matthew Dowell
Manager, Land Management
Agent & Attorney-in-Fact

Fort Bend County

By:  _____
KP George
County Judge

STATE OF TEXAS }

COUNTY OF HARRIS }

This instrument was acknowledged before me on _____, 2020, by Matthew R. Dowell, Manager, Land Management Division, Agent & Attorney-in-Fact for CenterPoint Energy Houston Electric, LLC, a Texas limited liability company, on behalf of said company.

Notary Public in and for the State of Texas

STATE OF TEXAS }

COUNTY OF FORT BEND }

This instrument was acknowledged before me on October 6, 2020, by KP George, County Judge of Fort Bend County, acknowledging he has full authority to execute the foregoing document and that he executed the same for the purposes and consideration therein expressed on the behalf of said county.

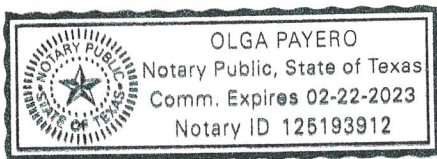

Olga Payero
Notary Public in and for the State of Texas

Exhibit "A"

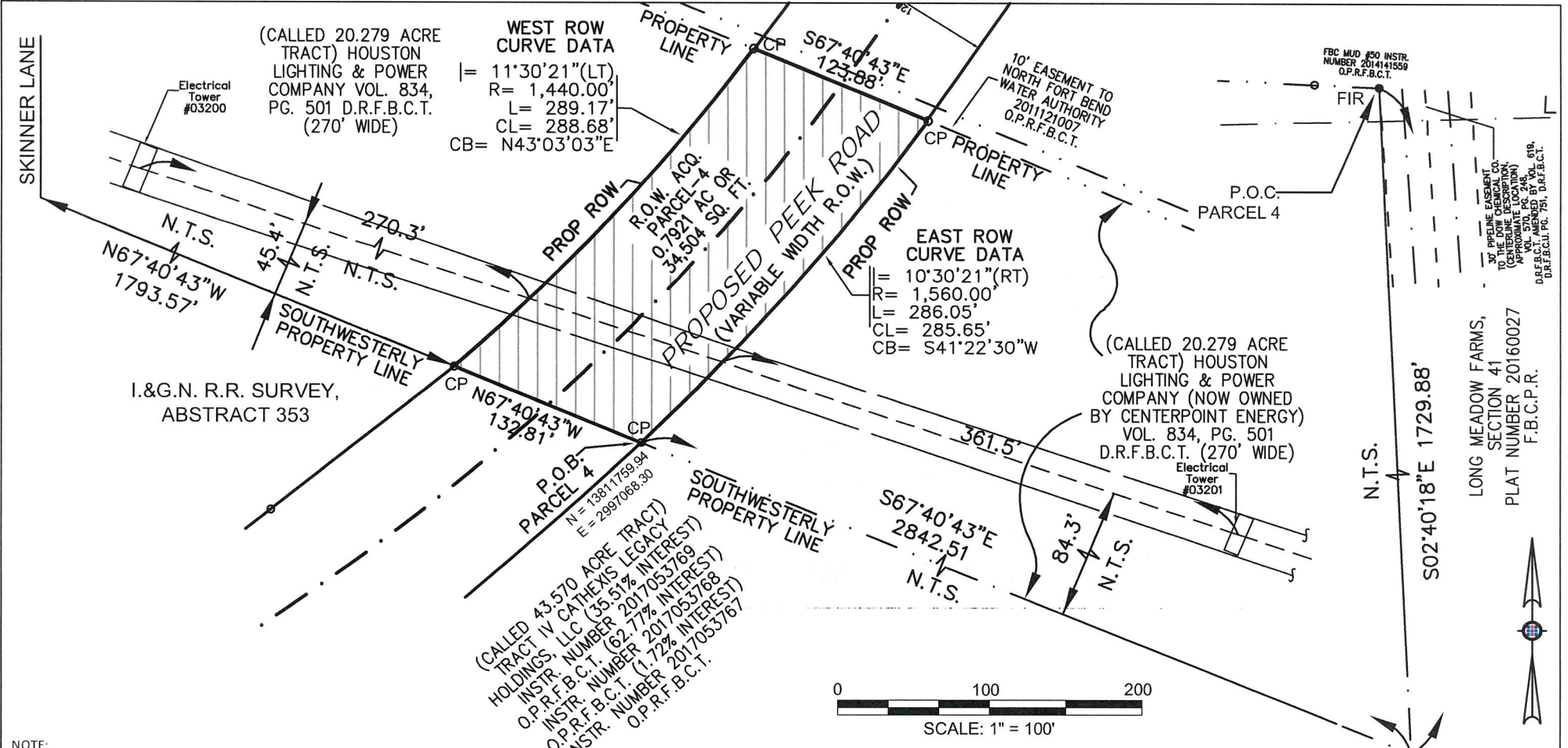

NOTE:

Bearings are referenced to the Texas State Plane Coordinate System, Texas South Central Zone (4204), North American Datum NAD 83 (2011), EPOCH 2010.00; distances and coordinates are surface values in U.S. Survey Feet, to convert to Grid divide Surface values by 1.00013.

CERTIFICATE OF SURVEY

This is to certify that this map and the survey on which it is based substantially complies with the current Texas Society of Professional Surveyors Standards and Specifications for a Category 1a Condition II Land Title Survey.

John Mark Otto
 John Mark Otto
 Texas Registered Professional Land Surveyor #6672
 June 9, 2020
 motto@halff.com



LEGEND:

- | | | | |
|--------|-------------------------|--------|-----------------------|
| FIR | Found Iron Rod | P.O.C. | Point of Commencement |
| FIP | Found Iron Pipe | CP | Computed Point |
| SIR | Set Iron Rod | N.T.S. | Not to Scale |
| FPK | Found pk Nail | | |
| FMON | Found Concrete Monument | | |
| P.O.B. | Point of Beginning | | |
| | | | R.O.W. ACQ Parcel |

14800 ST. MARY'S LANE, SUITE 160
 HOUSTON, TEXAS 77079-2943
 TEL (713) 588-2450
 FAX (281) 310-5259
 TBPLS FIRM NO. 10029606

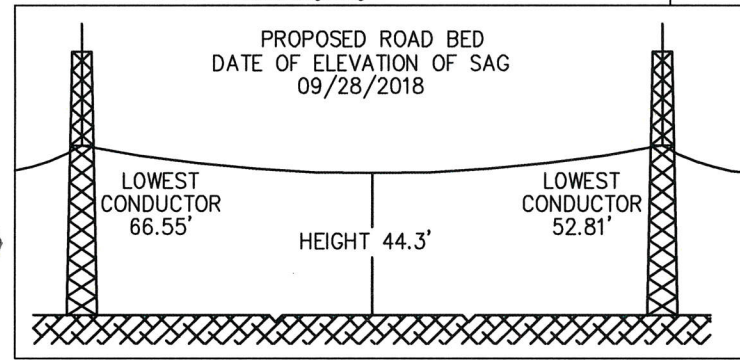

CNP ROAD CROSSING
 Fort Bend County, Texas

EXTENSION OF PEEK ROAD
 CENTERPOINT ENERGY TRACT
 FORT BEND COUNTY, TEXAS

Project No.: 34106.001
Issued: 06/09/2020
Drawn By: JC Chk By: MO
Sheet Number: 1 of 1
Scale: AS-SHOWN

I:\34000s\34106\001\CADD\Sheets\VE\XH01-ROAD CROSSING-34106.dwg June 09, 2020, 1:40:25 PM, ah3757

SPECIFICATION

**CENTERPOINT ENERGY HOUSTON ELECTRIC, LLC
P. O. BOX 1700, HOUSTON, TEXAS 77251-1500**

A. CONSTRUCTION

Reference Drawings:

CenterPoint Energy Transmission Standards Manual

Drawing No.: 006-203-01

006-203-02

006-203-04

006-203-07

GC3GATE

Hike and Bike Trail Specification

Reference Specifications:

- **CenterPoint Energy #007-229-06**
- **Texas Health & Safety Code – Chapter 752**
- **Federal Regulations, Title 29, CFR 1926.651, CFR 1910.333 ASTM C76**
- **Texas Highway Department Standard Specifications for Construction of Highways, Streets and Bridges: Item 162,Item 164,Item 166**
- **American Association of State Highway and Transportation Officials (AASHTO) 17TH Edition-2002**

B. SPECIAL AND TECHNICAL CONDITIONS, FLEXIBLE BASE ROAD AND YARD PAVING

REFERENCE SPECIFICATIONS:

Texas Highway Department (THD) Item 260

a/k/a Texas Department of Transportation (TxDOT)

1972 Standards for Construction Item 264

Of Highways, Streets and Bridges Item 270

Texas Highway Department	Tex-101E-1966	ASTM C14-75
Test Methods	Tex-104E-1968	ASTM C76-75
	Tex 106E-1962	ASTM C506-75
	Tex 110 E 1968	ASTM C150-76
	Tex 114E-1965	ASTM D2487-69
	Tex 115E 1962	AWPA C1-73
	Tex-116E 1962	AWPA C2-73
		AWPA A5-76
		AWPA P8-64
		AWPA P9-73

NO.	DATE	REVISION SECTION(S) AFFECTED	BY	CH	APP
1	07/03/86	Created	RDT	RNM	REB
2	05/05/03	Revised all sections	LRS	LRS	MJP
3	02/18/08	Revised all – Split Sec. 9	LRS	LRS	MJP
4	10/20/09	Revised Sect. 4	LRS	LRS	MJP
5	01/19/12	Revised Gate & Access Widths	LRS	LRS	MJP
6	02/10/14	Overall Revision	MDL	LRS	JHD

SPECIFICATION			
SHEET 1 of 35 SHEETS			
SPEC ID	007	231	79

CONTENTS

<u>Item No.</u>	<u>Title</u>	<u>Page No.</u>
1.0	SCOPE	3
2.0	DEFINITIONS	3
3.0	GENERAL REQUIREMENTS FOR CONSTRUCTION	4
4.0	SPECIAL REQUIREMENTS FOR PIPELINES AND VALVE SITES, COMMUNICATION CABLES AND CABLE TELEVISION INSTALLATIONS	9
5.0	SPECIAL REQUIREMENTS FOR DRAINAGE DITCHES	12
6.0	SPECIAL REQUIREMENTS FOR STREETS AND ROADS, HIKE AND BIKE TRAILS, AND PLAY GROUND EQUIPMENT	12
7.0	SPECIAL REQUIREMENTS FOR SPUR TRACKS	13
8.0	SPECIAL REQUIREMENTS FOR PARKING FACILITIES	13
9.0	SPECIAL REQUIREMENTS FOR NURSERY OPERATIONS	14
10.0	SPECIAL REQUIREMENTS FOR DECORATIVE PLANTING	14
11.0	SPECIAL REQUIREMENTS FOR PROTECTING CULTURAL RESOURCES, ARCHAEOLOGICAL SITES, AND THREATENED AND ENDANGERED PLANTS AND ANIMALS	15
12.0	SPECIFICATION FOR SPECIAL AND TECHNICAL CONDITIONS FLEXIBLE BASE ROAD AND YARD PAVING, #007-229-06	26

SPECIFICATION			
SHEET	2	of	35 SHEETS
SPEC ID	007	231	79

1.0 SCOPE

- a. This specification covers the requirements that a Grantee/Contractor shall adhere to when performing work on the property of CenterPoint Energy.
- b. At the time of this revision, the active Company Representatives for these specifications are:

Janice Coburn
Office 713-207-6138
Cell 281-460-0635

Travis Drabek
Office 713-207-6480
Cell 832-623-1326

D. Scott Humble
Office 713-207-6747
Cell 713-855-7836

Robert (Bobby) Sloan
Office 713-207-4321
Cell 832-547-5911

2.0 DEFINITIONS

- a. Company – CenterPoint Energy Houston Electric, LLC, which also may be referred to as Grantor in associated documents.
- b. Company’s Representative - The person or persons designated in the agreement to inspect the work performed on Company Property.
- c. Company’s Property - All property in which the company has an interest (easement or fee) including distribution easements, district office locations, and substations as they pertain to transmission use including towers, poles and wires, which also may be referred to as Grantor’s Property in associated documents
- d. Agreement – The written contract, letter agreement, or Document by which the company formally authorizes the use of its property by an outside party
- e. Grantee - The actual owner, developer, lessee, private person, partnership, company, corporation or governmental entity that is responsible for the maintenance and control of the facility or work authorized by the Agreement, which also may be referred to as Grantee in associated documents.
- f. Contractor – Any individual or business firm, separate from the grantee, but contracting to perform or supply part or all of the activity or facilities under the Grantee.

SPECIFICATION			
SHEET	3	of	35 SHEETS
SPEC ID	007	231	79

- g. Subcontractor - Any individual or business firm, separate from the contractor, but contracting to perform or supply part or all of the activity or facilities under the Contractor. Any work performed by the Subcontractor and its agents or employees shall comply with the provisions of the Agreement as if they were employees of the Contractor.

3.0 GENERAL REQUIREMENTS FOR CONSTRUCTION

- a. The following General Requirements in this section are applicable to a Grantee/Contractor requesting permission to perform construction work on Company's Property. The Special Requirements in other sections apply in addition to these General Requirements.
- b. Any violation of the requirements contained herein shall be considered as grounds, by the Company's Representative, to stop the construction until corrective actions are taken.
- c. No work shall be performed on Saturdays, Sundays or holidays on Company's Property unless approved by the Company's Representative forty-eight (48) hours in advance.
- d. The Grantee/Contractor shall furnish to the Company's Representative access at all times to the work being done and to the premises used by the Grantee/Contractor, and shall provide every reasonable accommodation for the purpose of inspection, even to the extent of discontinuing portions of the work temporarily, or of uncovering or taking down portions of finished work.
- e. Upon project completion, the Grantee/Contractor shall return Company's Property to its original condition or better, including roads, fences, and gates.
 - The Grantee/Contractor shall grade Company's Property to a smooth finish, and all excess material shall be either removed from, or distributed on Company's Property as directed by the Company's Representative.
 - All swales, ditches, and other surface graded areas disturbed during construction shall be seeded with Bermuda grass in accordance with Texas Highway Department Item 164. Fertilizer application shall conform to Texas Highway Department Item 166 and shall have an analysis of 16-8-8.
 - All debris, vegetation or cleared materials shall be removed from Company's Property by the Grantee/Contractor, including:
 - ❖ Trash, rubble and any flammable materials.
 - ❖ Sand, concrete and construction materials.

SPECIFICATION			
SHEET	4	of	35 SHEETS
SPEC ID	007	231	79

- ❖ Containers of any type or character for the purpose of storing trash.
- ❖ Any material defined in environmental regulations as a solid waste, regulated toxic material or hazardous material.

f. DOCUMENTATION REQUIREMENTS

- The Grantee/Contractor shall have a copy of the signed Agreement at all times at the construction site where the operation of equipment is within Company's Property. It is the Grantee's responsibility to provide a copy of this specification to the Contractor and to ensure that all the provisions in the Agreement are followed.
- Any necessary field changes or modifications to the Agreement must be approved in writing by the Company's Representative prior to construction by the Grantee/Contractor.
- It is the Grantee/Contractor's responsibility to examine all the available records and to make a field inspection of the site and Company's Property for determination of the surface conditions and surface water conditions to be encountered, and the character of equipment and facilities needed for the desired work.

g. NOTIFICATION REQUIREMENTS

- The Grantee/Contractor shall be responsible for notifying all parties having an interest in or an easement on, under or above the subject Company's Property. The construction requirements of the parties with prior rights shall be observed; however, the Company's Specification for Construction shall be adhered to as a minimum.
- The Grantee/Contractor shall notify the Company's Representative seven (7) days prior to beginning any type of work so that an inspection of Company's facilities and/or properties can be arranged. The Grantee/Contractor shall provide the name and telephone number of their representative responsible for the construction activities to coordinate a preliminary inspection. The executing party of the Agreement shall pay the repair cost for damages to Company's facilities caused by the Grantee/Contractor.
- The Grantee/Contractor shall be responsible to call the One-Call Network at "8-1-1", forty- eight (48) hours prior to construction, to locate the Company's underground fiber optics line, and/or underground distribution facilities, and/or underground transmission facilities.

S P E C I F I C A T I O N			
SHEET	5	of	35 SHEETS
SPEC ID	007	231	79

h. DAMAGE MITIGATION REQUIREMENTS

- Any use of land necessary by the Grantee/Contractor's operations which causes damage to property, crops, etc. shall be mitigated by the Grantee/Contractor at his expense.
- Any damage to Company's facilities or Company's Property caused by the Grantee/Contractor's operations shall be mitigated by the Grantee/Contractor at his expense.

i. SAFETY AND EQUIPMENT REQUIREMENTS

- It shall be the Grantee's responsibility to ensure that the Contractor be familiar with and comply with all local, state, and federal codes (i.e. Texas Health and Safety Code Chapter 752 and Federal Regulations, Title 29, CFR 1910.333, CFR 1926.1407-1411) for construction operations in close proximity to electrical power lines. The Grantee/Contractor shall comply with all applicable federal, state, and local environmental regulations concerning the loading and transportation of hazardous materials.
- The Grantee/Contractor shall take all precautions necessary, shall be responsible for the safety of the work, and shall maintain all lights, guards, barriers, barricades, signs, temporary passageways, or other protection necessary for that purpose. The work shall be carried on to completion without damage to any work or property of the Company or of others and without interference with the operation of existing machinery or equipment.
- The Grantee/Contractor shall be responsible at all times for the safety of the general public and for the protection of persons who may for any reason enter within the limits of his work and shall comply with all the laws of the State of Texas and the United States and with all valid rules and regulations now in force or hereafter adopted pursuant there to. Effective barricades with acceptable warning and detour signs shall protect roads and highways closed to traffic. All barricades and obstructions shall be illuminated at night, and all lights shall be kept burning from sunset to sunrise. The Grantee/Contractor shall bear the entire expense and shall not be reimbursed directly or separately by the Company for providing and maintaining all necessary or required barricades, warning lights, danger signals, signs or other precautions for the protection of the work and safety of the public.

SPECIFICATION			
SHEET	6	of	35 SHEETS
SPEC ID	007	231	79

- If at any time the Grantee/Contractor's methods, materials or equipment appear to the Company's Representative to be unsafe, inefficient or inadequate for securing the safety of the workers, the public, or any Company's facilities, he may order the Grantee/Contractor to increase his safety, efficiency and adequacy, and the Grantee/Contractor shall comply with such orders. The failure of the Company's Representative to make such demands shall not relieve the Grantee/Contractor of his obligation to secure the quality and safe conduct of the work, and the grantee/Contractor alone shall be and remain liable and responsible for the safety, efficiency and adequacy of his methods, materials, working force and equipment, irrespective of whether or not any changes are made as a result of any orders received from the Company's Representative.
- The Grantee/Contractor shall immediately remove from the job, whenever requested to do so by the Company's Representative, any person considered to be disposed or disorderly, or for any other reason unsatisfactorily complying with the requirements of this specification, and such person shall not again be employed on the work without the consent of the Company.
- The Grantee/Contractor shall not permit or suffer the introduction or the use of intoxicating liquor or narcotic drugs upon any of the grounds occupied or controlled by the Company.
- No structure of any type shall be constructed on Company's Property unless a final set of detailed drawings have been reviewed and approved by the Transmission Operations Department. Structures include but are not limited to signs, fences, paving, lighting, drainage facilities, etc. All structures of any type must be properly grounded.
- No temporary fuel tanks shall be stored on Company's Property unless prior written approval has been granted. Prior to approval, a specific location will be determined by the Company's Representative and the Grantee/Contractor. Fuel tanks within Company's Property must be adequately grounded and bermed for spill protection.
- No equipment or material shall be permitted on Company's Property at a height greater than 15 feet above natural ground elevation, unless approved by the Company's Representative. Cranes, lifts, etc. shall be blocked so that operators may not bring the boom to a greater height.
- Trenching and excavation will not be permitted within twenty (20) feet of any structure foundation or other facilities measured at ground level unless approved by the Company's Representative.

S P E C I F I C A T I O N			
SHEET	7	of	35 SHEETS
SPEC ID	007	231	79

- Excavation shall comply with CFR 1926.651. The installation of sheet piling, cribbing or other protective measures beyond the scope of CFR 1926 .651 will be required if stipulated by the Company's Representative.
- No self-propelled equipment shall be allowed directly beneath a lattice tower.

j. RIGHT OF WAY ACCESS REQUIREMENTS

- The Grantee/Contractor shall not sell, assign, or remove equipment or materials which have been installed by or which are owned by the Company and may be necessary for right-of-way access or any other activities without the written consent of the Company's Representative.
- No equipment, material, or railroad cars shall be stored on Company's Property without prior written consent.
- A minimum 20-foot wide access path along Company's Property shall be kept free of obstacles at all times to provide a passable area for the Company's equipment to travel.
- The Grantee/Contractor upon the request of the Company's Representative shall use matting on the right-of-way for temporary access on or across Company's Property.

k. DRAINAGE REQUIREMENTS

- Under no circumstances shall the natural drainage pattern of Company's Property be blocked or altered by construction. All previously existing ditches shall be re-established.
- All reinforced concrete pipes installed on Company's Property should be Class IV as specified by ASTM Specification C76 and should have a minimum of 12 inches of cover.
- All corrugated steel pipe and high density polyethylene pipe used for culverts and installed on Company's Property should be 16 gauges with 2 & 2/3" x 1/2" or 3" x 1" corrugations and have a minimum of 12 inches of cover or manufacturer's specified cover.
- The top of all manholes shall be built at final grade and must be capable of HS-20-44 loading, (A ASHTO 17th Edition-2002). All manholes must be protected with a minimum of four 6" diameter bollards made of wood or steel that are 6' long and set at least 24" in the ground with 48" above the ground.

SPECIFICATION			
SHEET	8	of	35 SHEETS
SPEC ID	007	231	79

I. SPOILING REQUIREMENTS

- No spoiling is allowed unless written approval has been obtained.
- Spoiling, if allowed, shall be done as directed by the Company's Representative. The spoil material shall be free of concrete, asphalt, steel, wood, or any other objectionable material. Spoil material shall not be stockpiled or placed over any distribution manholes, pull holes, etc. The spoil material shall be spread in lifts not to exceed 12" and compacted as required by the Company's Representative. The end results of spoiling and grading shall yield positive drainage and flow with no ponding.
- The elevation beneath any of the Company's structures within the limits of the proposed work shall be maintained equal to or greater than the surrounding finished grade elevation. Spoil material, if approved in writing, shall not exceed a point six (6) inches below the top elevation of the concrete cap of a tower foundation. Any spoil material added beneath the tower shall be compacted to 95% density with a tamper or hand vibratory equipment and shaped to a smooth finish to provide proper drainage.

4.0 SPECIAL REQUIREMENTS FOR PIPELINES AND VALVE SITES, COMMUNICATION CABLES AND CABLE TELEVISION INSTALLATIONS

- a. Pipelines shall have a minimum cover of four (4) feet, measured from the top of the pipe to the natural ground level, unless otherwise specified in the Agreement.
- b. Pipelines to be installed within twenty (20) feet of any structure foundation shall be installed by either boring, tunneling, or other protective methods approved by the Company Representative. Where boring is performed, the hole shall not be more than one (1) inch greater than the outside diameter of the pipe and the protective coating or casing. Where tunneling is performed and column bents of concrete are used, the top of the concrete shall be a minimum of three (3) feet below ground level and the remainder of the column shall be filled and compacted at lifts not to exceed twelve (12) inches to 95% Standard Proctor density. De-watering will not be permitted unless approved by the Company's Representative.
- c. Trenches shall be backfilled, sufficiently compacted to prevent future settlement, and crowned as required by the Company's Representative. For any settlement that occurs as a result of access for the associated pipeline installation, the owner of the pipeline, upon request, shall fill or smooth the Company's right-of-way as directed.

SPECIFICATION			
SHEET	9	of	35 SHEETS
SPEC ID	007	231	79

- d. No structure of any type shall be constructed on Company's Property unless described in detail in the formal agreement document, except for test point terminals and pipeline markers, which shall be installed in locations such that they do not create an obstruction to Company's equipment traveling within Company's Property.
- e. If at any time the pipe is abandoned, the pipe shall be removed by the pipeline owner. If the pipe cannot be removed because of possible damage to Company's facilities (tower foundation, poles, etc.), the pipeline shall be cut 20' away from each side of the Company facility and the abandoned pipe section filled with grout to prevent future caving or settling.
- f. Pipelines with a proposed location between a Company's structure and a down guy anchor or other appurtenance will be bored or tunneled unless specific approval has been granted by the Company's Representative.
- g. New or relocated pipeline occupations that are located between a lattice tower's foundations will require the Company to install "Mower Guards" (Company Drawing #006-203-07) at each tower at the expense of the requesting pipeline company.
- h. The following are additional requirements applicable to installations of valve and metering sites within Company's Property.
- No valve site or station is to be located closer than fifty (50) feet to a transmission structure or appurtenance without exclusive written consent.
 - Valve sites or stations are to be located on Company's Property such that they do not limit access along Company's Property.
 - Valve sites or stations are to have perimeter barricades or fences installed in order to prevent damage from equipment traveling along Company's Property.
 - Valve sites or stations, plus an additional three (3) feet outside the site area, shall be kept free of high grass and weeds at all times by the valve owners.
 - Valve sites or stations are to be well marked with the owner's name and telephone number to be called in cases of emergency.
 - No blow-off vents or flares are to be located on Company's Property.
 - Grounding/Anode Beds will be treated as a Valve Site, separately from the pipelines.

S P E C I F I C A T I O N			
SHEET	10	of	35 SHEETS
SPEC ID	007	231	79

i. The following are additional requirements for pipeline crossings of the Company's underground electric distribution facilities.

- The Company will furnish upon Grantee/Contractor's request any drawings of the existing underground distribution facilities.
- If a crossing is required, the pipeline shall be installed beneath the Company's underground distribution facilities. A minimum vertical clearance of eighteen (18) inches must be maintained between the Company's underground distribution facilities and any other facilities (i.e. outside pipe wall to outside concrete encasement or pipe wall).
- If a pipeline is installed parallel to the Company's underground electric distribution facilities, a minimum horizontal clearance of five (5) feet must be maintained between the Company's underground distribution facilities and any other facilities (i.e. outside pipe wall to outside concrete encasement or pipe wall).
- If the Company's concrete encased duct bank is to be exposed during the installation or maintenance of a pipeline, the Company's duct bank must be fully supported every four (4) feet.
- Upon completion of the work, Grantee shall furnish the Company with a complete set of as-built drawings. Any substitutions or changes made by the Contractor/Grantee for the purpose of fabrication or installation shall be marked by Contractor/Grantee on those drawings and accompanied by a complete revised metes and bounds or centerline description if applicable.

j. COMMUNICATION CABLES AND CABLE TELEVISION INSTALLATIONS

- Overhead cables must be approved by a Representative from the Asset Planning and Optimization Transmission Encroachment & 3rd Party Use Department, for location and maximum and minimum height requirements.
- All underground occupations must be buried with a minimum 4.0' of cover and all above ground appurtenances must be approved for location.

SPECIFICATION				
SHEET	11	of	35	SHEETS
SPEC ID	007		231	79

5.0 SPECIAL REQUIREMENTS FOR DRAINAGE DITCHES

- a. Ditch side slopes along Company's Property shall be "Asphalt Mulch Seeded" with Bermuda grass in accordance with Texas Highway Department, Item 164. Application of seed shall be at the rate of forty (40) pounds per acre. Asphalt Film Spray Emulsion SS-1, CSS-1, CMS-25, or MS-2 shall be used. This spray is to be applied at the rate of 0.2 to 0.4 gallons per square yard. Fertilizer application shall conform to Texas Highway Department, Item 166 and shall have an analysis of 16-8-8 urea form.

ALTERNATE: The Grantee/Contractor may use solid "Block Sodding" on ditch side slopes in accordance with Texas Highway Department, Item 162.

- b. Cement stabilized limestone and cement stabilized sand shall conform to Company's Specification #007-229-06, attached hereto and made a part hereof.
- c. Unless specified otherwise, the Grantee/Contractor shall install, for the exclusive use of the Company, a culvert crossing for access to Company's Property with a roadway width of twenty four (24) feet. The Grantee/Contractor shall install the roadway at the location stipulated in the Agreement or as determined by the Company's Representative.
- d. Ditch design shall be such that erosion and slope stability is controlled by flat side slopes, natural vegetation, riprap or other approved methods. The side slopes of ditches shall not be steeper than 4:1.
- e. The high bank of any ditch shall not be closer than twenty four (24) feet to any structure foundation measured at ground level unless approved by the Company's Representative. The high bank of any ditch shall not be closer than three (3) feet to any wood poles or appurtenances measured at ground level unless approved by the Company's Representative. If this is not possible, the wood poles will be braced or relocated by the Company at the Grantee/Contractor's expense.

6.0 SPECIAL REQUIREMENTS FOR STREETS, ROADS, HIKE AND BIKE TRAILS, AND PLAY GROUND EQUIPMENT

- a. Barricades to protect the Company's structures shall be installed as required before construction of the street or road begins.
- b. Unless specified otherwise, the Grantee/Contractor shall install, for the exclusive use by the Company, a twenty four (24) foot wide drive on both sides of the street or road. The Grantee/Contractor shall install the drive at the location stipulated in the Agreement or as determined by the Company's Representative. Curb cut-outs shall be installed with a five (5) foot radius.

SPECIFICATION				
SHEET	12	of	35	SHEETS
SPEC ID	007		231	79

- c. Adequate drainage for Company's Property shall be provided and indicated on plan and profile drawings at each street or road crossing. Installation of drainage structures and/or shaping of the adjacent property to ensure proper drainage of Company's Property shall be done at Grantee/Contractor's expense.
- d. Hike and Bike Trail minimum standards are referenced on CenterPoint Energy Transmission Standard, Hike and Bike Trails, Minimum Standards Drawings. Subject to full review and subject to change based on the field notes.
- e. PLAY GROUP EQUIPMENT or ANY RECREATION FACILITIES is prohibited within Company's Property without any exception.

7.0 SPECIAL REQUIREMENTS FOR SPUR TRACKS

- a. Company's structures located within twelve (12) feet of the nearest rail of the proposed rail spur shall be relocated at the spur track owner's expense. The Company's construction forces will relocate the structures.
- b. For the exclusive use of the Company, the Grantee/Contractor shall install a twenty four (24) foot wide grade crossing over the spur track in accordance with local railroad specifications. Before construction can begin, the Grantee/Contractor shall assume responsibility for the exact location of the grade crossing with respect to the Company's right-of-way line as determined by the Company's Representative. If the spur right-of-way is to be cross-fenced, a twenty four (24) foot wide gate shall be installed in each cross fence at/and parallel to the grade crossing.
- c. The top rail elevation shall not exceed four (4) feet above the natural ground elevation of the Company's right-of-way.

8.0 SPECIAL REQUIREMENTS FOR PARKING FACILITIES

- a. Parking lot plans showing the area to be surfaced, curbs, fences, drainage and traffic access routes as applicable must be submitted to and approved by the Company's Representative prior to the granting of the Agreement.
- b. No through roads will be allowed along Company's Property; therefore, if the parking lot has multiple entrances, the lot must be so constructed that through traffic is not possible.
- c. Company's Property requested for parking must be immediately adjacent or substantially close to the Grantee's property.

S P E C I F I C A T I O N			
SHEET	13	of	35 SHEETS
SPEC ID	007	231	79

- d. The Grantee/Contractor shall be responsible for any damage to Company's facilities. This includes all existing structures as well as future structures. Barriers will be required if the proposed parking facility or any drives associated with the parking area are closer than ten (10) feet to any transmission facility. Barriers in accordance with Company's Drawing #006-203-01, 006-203-02, or 006-203-04, attached hereto and made a part hereof, shall be installed.
- e. If fences or traffic restrictors are placed across Company's Property, the Grantee/Contractor must install a twenty four (24) foot gate in accordance with Company's Drawing #GC3GATE, attached hereto and made a part hereof, on which the Company will install a chain and lock.
- f. The Company reserves the right to enter and traverse any parking facility as required for inspection, maintenance or construction purposes and reserves the right to cancel all or part of the agreement as may be required for the installation of future facilities or maintenance of existing facilities.

9.0 SPECIAL REQUIREMENTS FOR NURSERY OPERATIONS

- a. Liquid fertilizer is not allowed on Company's Property.
- b. No permanent sprinkler systems are allowed on Company's Property.
- c. Only containerized trees and plants will be allowed on nursery operations and only to a maximum height of ten (10) feet.
- d. No berms or earthen mounds will be allowed.
- e. The Company is not to be held responsible for any plants that may be damaged due to emergency repair of the Company's facilities.

10.0 SPECIAL REQUIREMENTS FOR DECORATIVE PLANTING

- a. No plants which at maturity are taller than ten (10) feet will be approved and subject to approval on a case by case basis. No planting shall be made closer than twenty (20) feet to any Company's structure.
- b. No trees of any type will be allowed.
- c. No berms or earthen mounds will be allowed.
- d. No permanent sprinkler systems are allowed on Company's Property.
- e. Liquid fertilizer is not allowed on Company's Property.

S P E C I F I C A T I O N			
SHEET	14	of	35 SHEETS
SPEC ID	007	231	79

- f. The Company reserves the right to have plantings removed by the Grantee/Contractor without notice. Should plantings not be removed, the Company will remove the plantings and not be liable for their replacement.
- g. Any vegetation placed within Company's Property without prior written approval may be removed by the Company. The Grantee/Contractor shall be responsible for reimbursing the Company for removal of unauthorized plantings.
- h. The Company is not to be held responsible for any decorative grass or plants that may be damaged.
- i. Grantee shall keep Company Property free of high grass, weeds, and trash within the area covered by the Agreement.

11.0 SPECIAL REQUIREMENTS FOR PROTECTING CULTURAL RESOURCES, ARCHAEOLOGICAL SITES, AND THREATENED AND ENDANGERED PLANTS AND ANIMALS

- a. Archaeological and historical sites
 - Known or potential archaeological or historical site(s)
 - ❖ The Grantee/Contractor shall conspicuously mark the site areas in the field to ensure the areas are avoided by construction activities.
 - ❖ If a site is determined to be located in a wooded area, any necessary vegetation clearing shall be done in such a manner that the root zone is not disturbed until an archaeologist has completed and investigation of the site, including removal of all artifacts. This may be accomplished by using manually operated chain saws or mechanical cutters to cut down trees at ground level and lifting them onto trucks for transport out of the right of way rather than dragging them. When archaeological work is completed, stump grinders may be used to remove the remaining portions of large trees below ground level, after which the surrounding surface can be prepared for construction. More specific procedures for avoidance or lessening of damage to sites will be decided on a site-by-site basis, or as directed by the State Historic Preservation Office.
 - ❖ In certain circumstances, it may be necessary for vehicles to cross the identified archaeological/ historical areas. In such cases, loose earth fill, or other temporary ground cover, in a thickness necessary to prevent damage by the passage of vehicles over the site surface will be placed on such sites. The fill shall be a contrasting color or texture so as to allow re-establishment of the original site surface at a later date. The Grantee/Contractor shall document the placement and removal of such temporary fill.

S P E C I F I C A T I O N			
SHEET	15	of	35 SHEETS
SPEC ID	007	231	79

- Unknown archaeological or historical site(s)
 - ❖ Upon discovery of any evidence of an archaeological or historical site (e.g. accumulations of oyster shells or other seashells, pottery or pottery pieces, animal or human bones, rusted metal such as nails or cannon balls), all construction operations in the immediate vicinity shall cease. The Grantee/ Contractor shall promptly contact the Company's Representative.
 - ❖ The Company will contact qualified environmental contractors to investigate the discovered site in accordance with applicable procedures and guidelines. The area of significance will be conspicuously marked in the field so that construction activities may proceed while avoiding the site.
- Mitigation process
 - ❖ If a structure or site cannot be protected through any relocation, stabilization or restoration technique, then mitigation of the construction effects on archaeological and/or historical sites will be performed in accordance with applicable procedures and guidelines as directed by the State Historic Preservation Office.

b. Endangered or threatened plants and animals

- Known locations of species and/or their habitats
 - ❖ The company may provide the Grantee/Contractor any previously documented sites of any known endangered and threatened species that it has discovered along the construction route. Where such documentation is provided, the Grantee/Contractor shall implement any mitigating actions required by the Company.
- Unknown locations of species and/or their habitats
 - ❖ If during construction, the Grantee/Contractor discovers an endangered or threatened plant or animal species, the Grantee/Contractor shall cease all work in that immediate area. The Grantee/Contractor shall promptly notify the Company's Representative who will notify the appropriate State/Federal agencies for any required mitigating actions.

SPECIFICATION				
SHEET	16	of	35	SHEETS
SPEC ID	007		231	79

- ❖ If during construction, the Grantee/Contractor discovers an endangered or threatened plant or animal species, the Grantee/Contractor shall cease all work in that immediate area. The Grantee/Contractor shall promptly notify the Company's Representative who will notify the appropriate State/Federal agencies for any required mitigating actions.
- Mitigation process
 - ❖ Any mitigation concerning endangered and/or threatened species, applicable to the project construction, will be reviewed by the Company and communicated to the Grantee/Contractor. Only when necessary mitigation measures have been completed by the Grantee/Contractor will construction work be reinitiated

SPECIFICATION			
SHEET	17	of	35 SHEETS
SPEC ID	007	231	79

CENTERPOINT ENERGY
TRANSMISSION STANDARD

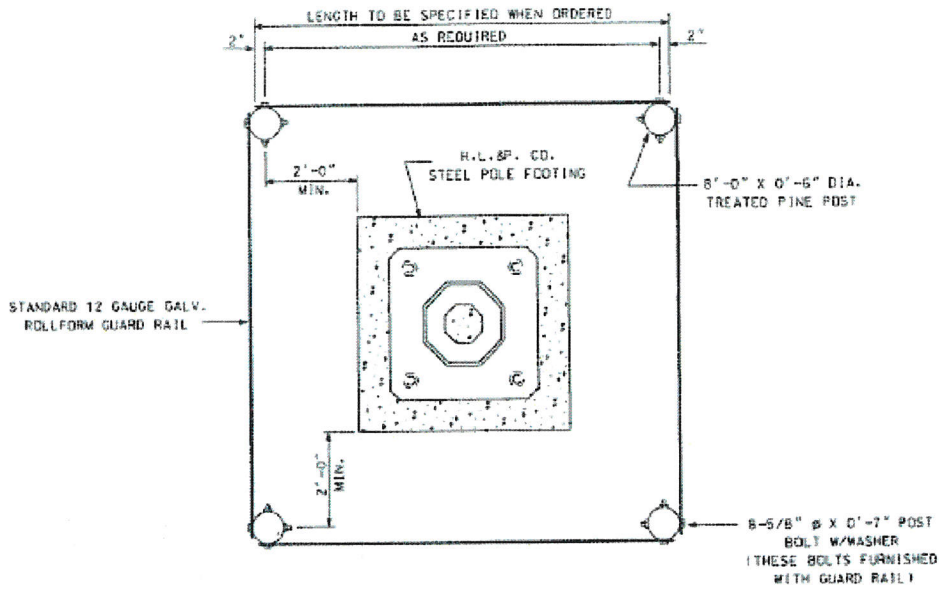

PLAN

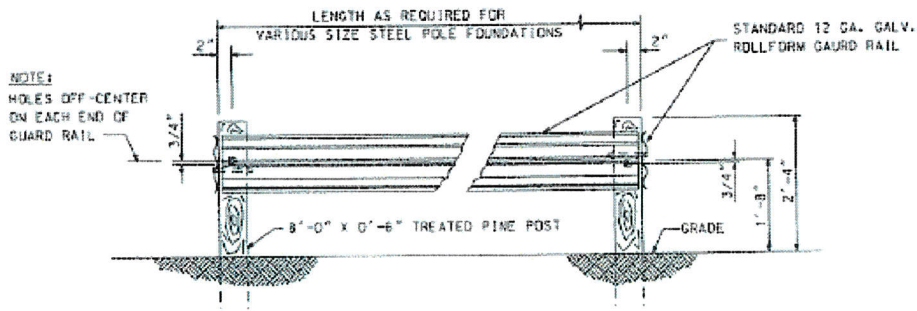

NOTE:
HOLES OFF CENTER
ON EACH END OF
GUARD RAIL

ELEVATION

FOR USE ON HOUSTON LIGHTING AND POWER CO.
RIGHTS-OF-WAY.

BARRIERS

**TYPICAL DETAILS
GALVANIZED ROLLFORM
STEEL POLE GUARD RAIL**

SCALE: NTS SHEET 1 OF 1 006-203-02

NO.	DATE	REVISION	BY	CHK	APP	APPR	DATE	DESCRIPTION
1	11-19-93	CONVERT TO CAD	AKW					

DRAWN	01-06-70	R. A. VAUGHN
CHECK		L. D. WISEMAN
COMP	01-09-70	E. ALTURNER
APPR		D. E. SIMMONS

SPECIFICATION			
SHEET 19 of 35 SHEETS			
SPEC ID	007	231	79

CENTERPOINT ENERGY
TRANSMISSION STANDARD

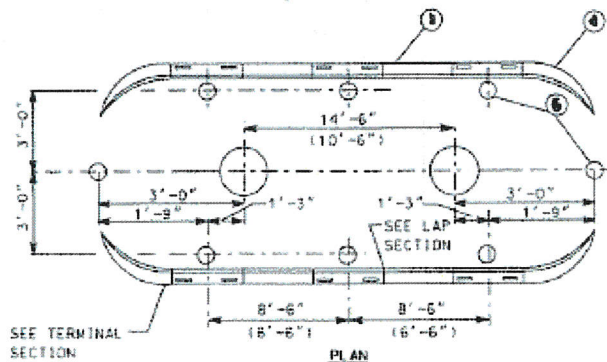
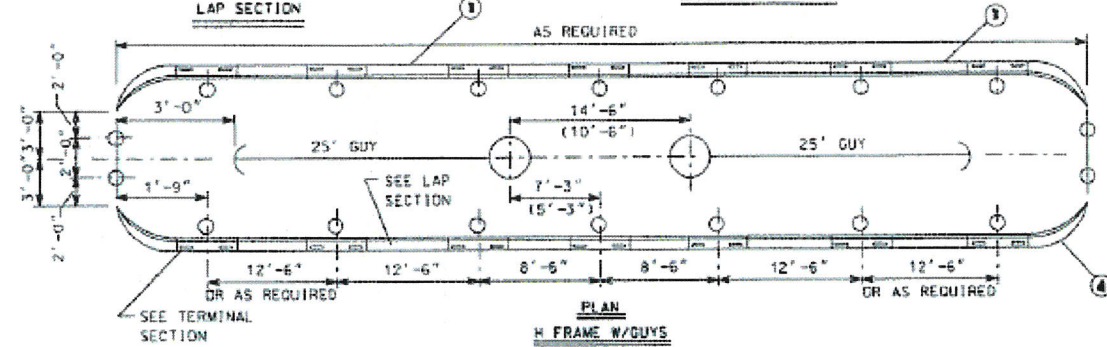
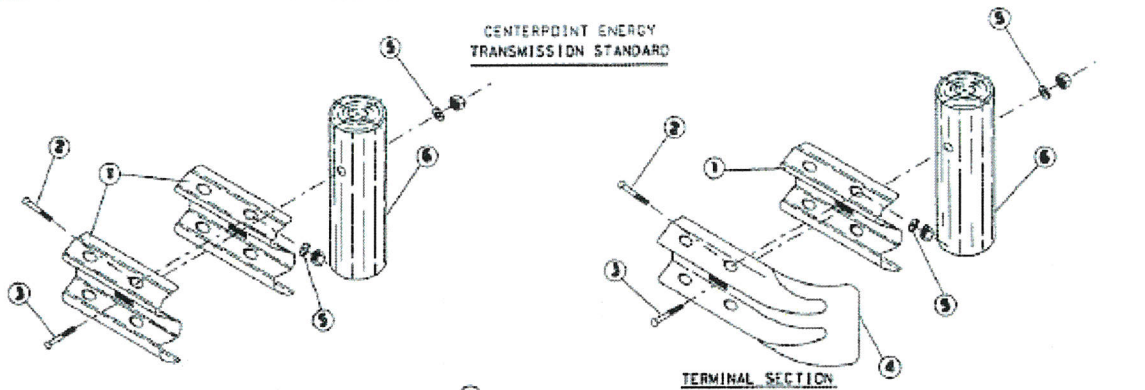

MATERIAL LIST		
ITEM NO.	DESCRIPTION	QTY (AS REQ BY JOB)
1	GUARDRAIL 1 1/2 GA. 1 SEE NOTE 3	
2	BUTTON HEAD BOLT W/NUT 5/8" Ø x 9 1/4" WITH OVAL SHOULDER	
3	BUTTON HEAD BOLT W/NUT 5/8" Ø x 9 1/2" WITH OVAL SHOULDER	
4	TERMINAL SECTION	
5	WASHER FOR 5/8" Ø BOLT	
6	GUARD POST 8'-0" WITH 6" TOP DIA.	

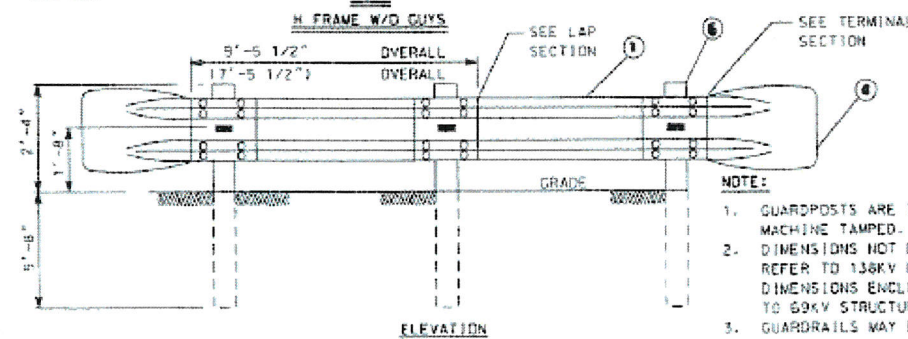

- NOTE:
- GUARDPOSTS ARE TO BE SET 5'-6" AND MACHINE TAMPED.
 - DIMENSIONS NOT ENCLOSED IN PARENTHESES REFER TO 138KV H-FRAME STRUCTURES. DIMENSIONS ENCLOSED IN PARENTHESES REFER TO 69KV STRUCTURES.
 - GUARDRAILS MAY BE ORDERED AND FURNISHED TO LENGTH DESIRED.

BARRIERS

**TYPICAL DETAILS
GALVANIZED ROLLFORM H-FRAME
GUARDRAIL**

NO.	DATE	REVISION	BY	CHE	APP	APPR	DATE
1	11-17-93	CONVERT TO CAD					

SCALE: NTS SHEET 1 OF 1 006-203-04

SPECIFICATION

SHEET 20 of 35 SHEETS

SPEC ID 007 231 79

**CENTERPOINT ENERGY
TRANSMISSION STANDARD**

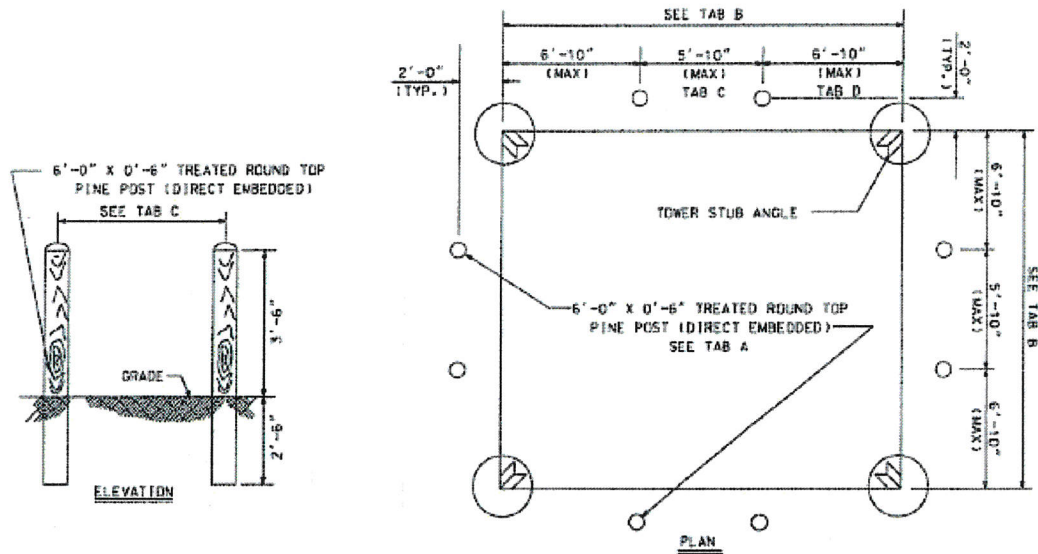

DIMENSIONAL SPACING OF WOOD BARRIERS FOR SQUARE BASE TOWERS			
A	B	C	D
NO. OF BARRIERS PER SIDE	DIMENSION BETWEEN TOWER LEGS	DIMENSION BETWEEN BARRIERS	DIMENSION BETWEEN BARRIERS AND TOWER LEG
2 BARRIERS	14'-9" TO 17'-5"	4'-11" TO 5'-10"	EVENLY SPACED
	17'-6" TO 19'-6"	5'-10" (MAX)	5'-10 1/2" TO 6'-10" (MAX)
3 BARRIERS	19'-7" TO 23'-4"	4'-11" TO 5'-10"	EVENLY SPACED
	23'-5" TO 25'-4"	5'-10" (MAX)	5'-10 1/2" TO 6'-10" (MAX)
4 BARRIERS	25'-5" TO 29'-2"	5'-1" TO 5'-10"	EVENLY SPACED
	29'-3" TO 31'-2"	5'-10" (MAX)	5'-10 1/2" TO 6'-10" (MAX)
5 BARRIERS	31'-3" TO 35'-0"	5'-2" TO 5'-10"	EVENLY SPACED
	35'-1" TO 37'-0"	5'-10" (MAX)	5'-10 1/2" TO 6'-10" (MAX)
6 BARRIERS	37'-1" TO 40'-10"	5'-3 1/2" TO 5'-10"	EVENLY SPACED
	40'-11" TO 42'-10"	5'-10" (MAX)	5'-10 1/2" TO 6'-10" (MAX)
7 BARRIERS	42'-11" TO 46'-8"	5'-4 1/2" TO 5'-10"	EVENLY SPACED
	46'-9" TO 48'-8"	5'-10" (MAX)	5'-10 1/2" TO 6'-10" (MAX)

INSTRUCTIONS:

1. MEASURE DISTANCE BETWEEN TOWER LEGS AT STUB ANGLES.
2. LOCATE DIMENSION IN TAB "B".
3. DETERMINE BARRIER SPACING FROM TAB "C" AND "D". BARRIERS MAY BE SPACED EVENLY OR UP TO A MAXIMUM OF 5'-10" BETWEEN BARRIERS AND A MAXIMUM OF 6'-10" BETWEEN THE END BARRIER AND TOWER LEG.
4. BARRIERS TO BE LOCATED 2'-0" OUTSIDE THE PERIMETER OF THE BASE, MEASURED FROM THE STUB ANGLE (SEE PLAN VIEW).
5. POST TO BE SET 2'-6" DEEP
6. THE CONTRACTOR IS RESPONSIBLE FOR LOCATING ALL UNDERGROUND UTILITIES BEFORE DIGGING.

LOCAL POST SUPPLIERS: SAM BASSETT LUMBER
ADDRESS: 3839 POLK STREET
PHONE: 713-223-9154

BARRIERS		
WOOD POST MOWER BARRIER INSTALLATION FOR TOWERS		
SCALE: NTS	SHEET 2 OF 2	006-203-07

NO.	DATE	REVISION	BY	CHK	APP	DRAWN 10-20-06 KL WHITE	CHECKED 10-20-06 RJ BUTTRICK
1	04-23-07	REVISED POST SUPPLIER	RJB	KLW	KLW	CDR 10-20-06 WD KOROSZ	APPR 10-20-06 WJ FANELTIS

SPECIFICATION			
SHEET 21 of 35 SHEETS			
SPEC ID	007	231	79

GC3GATE..

CENTERPOINT ENERGY
TRANSMISSION STANDARD

I T E M	DESCRIPTION	M/N	U N I T	QUANTITY			
				GAP GATE		TUBE GATE	
				NEW	MAINT	NEW	MAINT
	FCA 352			G	G	G	G
				C	C	C	C
				3	3	3	3
				G	G	G	G
				A	A	A	A
				T	T	T	T
				E	E	E	E
				F	F	F	F
1	POST, 10' TREATED PINE W/2"-10" TOPS	109299	EA	-	-	4	-
2	POST, 8' TREATED PINE W/3"-6" TOPS	100100	EA	4	4	-	-
3	POST, 7' TREATED PINE W/3" TOPS	100089	EA	4	4	2	-
4	WIRE, BARBED 12 1/2 GAUGE (1320')	111278	SP	-	.15	-	-
5	WIRE, BARBLESS STEEL 2 FLY GALV. (1320')	111267	SP	.25	.10	.10	-
6	STAPLES, 1 1/2" GALVANIZED	137263	LB	1	1	1	-
7	NAILS, WIRE 16D GALVANIZED	131350	LB	1	1	1	-
8	RIV T. CAPT HANDB. 9/16" DIA. 14"	110706	EA	-	-	4	2
9	WASHER, CURVED, 4"x4"x1/4", 11/16" HOLE	225701	EA	-	-	8	4
10	GATE, 6-RAIL TUBE, GALVANIZED 12"x50"	245425	EA	-	-	2	1
11	STAY, TWISTED #2, GALVANIZED	111265	EA	3	3	-	-
12	PADLOCK, HS DOUBLE BALL, STAINLESS STEEL, 2" OPENING	225147	EA	1	1	1	1
13	CHAIN, COIL 1/4"	136403	FT	5	5	2	2

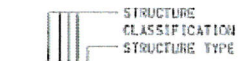

GC3.....

A/U KEY

STRUCTURE CLASSIFICATION

GATE - GATE

STRUCTURE TYPE

- F - GAP GATE (BARBLESS WIRE)
- G - GAP GATE (BARBED WIRE)
- S - TUBE GATE, 5-RAIL
- H - TUBE GATE & HARDWARE REPLACEMENT ONLY

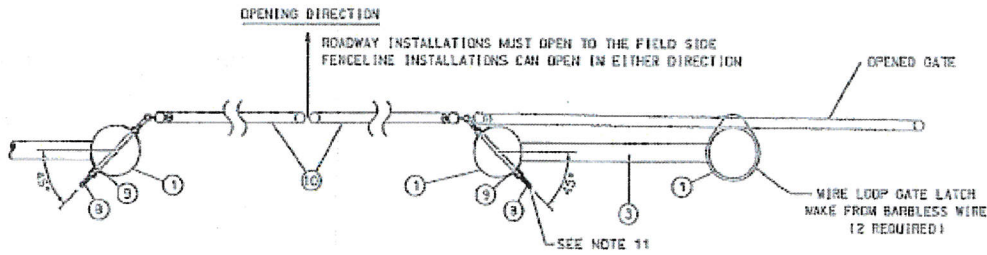

DETAIL "A"
POST AND GATE ATTACHMENT DETAIL

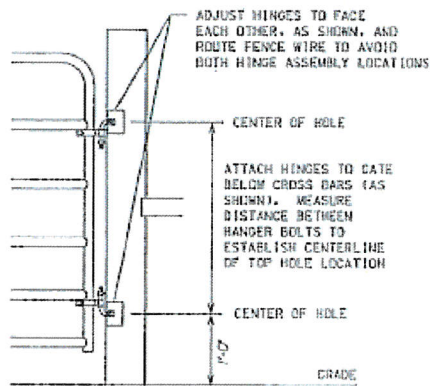

DETAIL "B"
GATE POST HINGE ATTACHMENT DETAIL

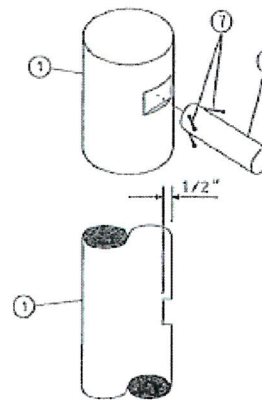

DETAIL "C"
HORIZONTAL WOOD BRACE DETAIL

GATES & CULVERTS

Sheet 23 of 36

NO.	DATE	REVISION	BY	CHK	APP	APPR		
3	02-27-06	REDRAWN FOR NEW 24' DESIGN	RMB	RMB	MJP	DRAWN	02-03-99	R.J. BUTTRICK
2	04-11-00	REPLACED FARM GATE W/ PIPE GATE	FBS	RJB	MJP	CHECK	02-03-99	R.J. BUTTRICK
1	01-08-99	ADDED BOM TO DRAWING T.O.CK	RJB	RJB	MJP	CONS	02-03-99	R.J. BUTTRICK
							02-04-99	M.L. PHELPS

SCALE: NTS SHEET 1 OF 2 GC3GATE

SPECIFICATION			
SHEET	22 of 35	SHEETS	
SPEC ID	007	231	79

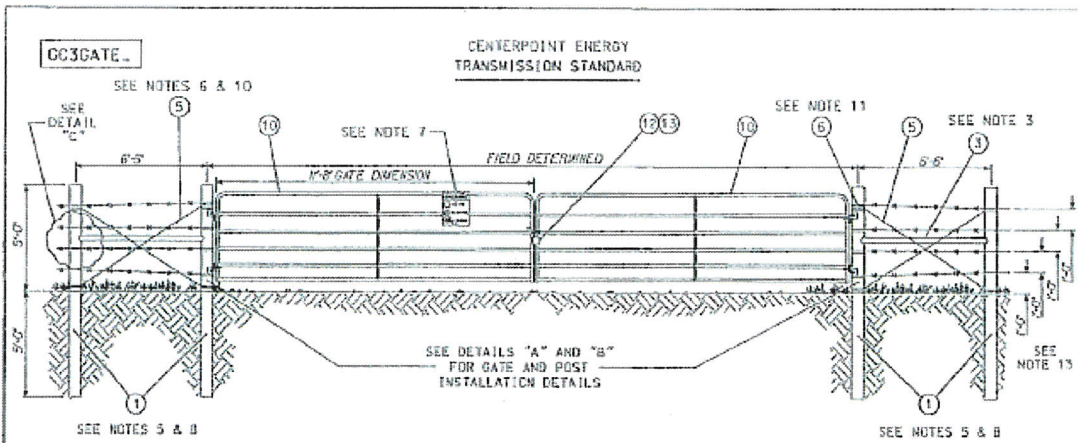

TYPICAL 24' DOUBLE STEEL TUBE GATE

GC3GATES 24' TUBE GATE
GC3GATER 12' TUBE GATE REPLACEMENT

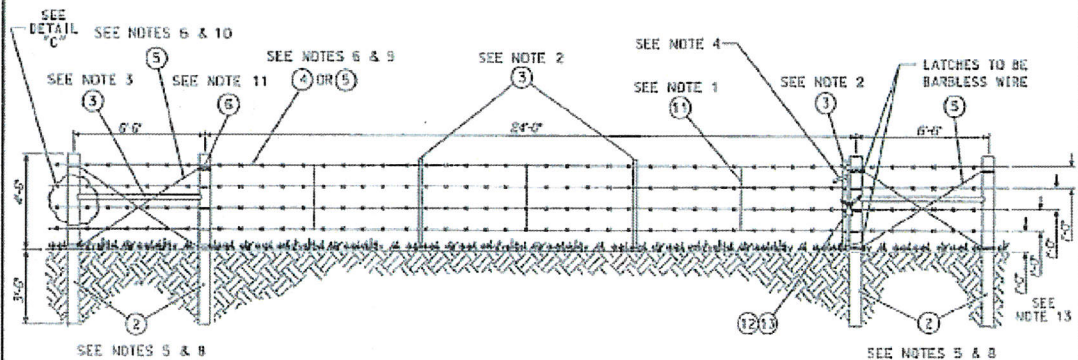

TYPICAL 24' GAP GATE

GC3GATEF 24' GAP GATE WITH BARBLESS WIRE
GC3GATEB 24' GAP GATE WITH BARBED WIRE

NOTES:

1. 2" DIAMETER WOOD POST MAY BE SUBSTITUTED FOR STAYS. (NON-STOCK ITEM).
2. VERTICAL BRACE POSTS AND LATCH POST (3) TO BE FABRICATED OUT OF POST FROM M/W 100089, CUT TO 4'-6".
3. HORIZONTAL BRACE POST (3) TO BE FABRICATED OUT OF POST FROM M/W 100089, CUT TO 6'-6".
4. WOOD CHEATER TO BE FABRICATED FROM WOOD POST SCRAP.
5. ALL TIMBER AND POSTS SHALL BE TREATED IN ACCORDANCE WITH ANPA SPEC. C-1, C-S, P-1 LATEST REVISION. FINAL NET RETENTION OF CREOSOTE TREATED BY ASSAY = 8 PCF.
6. ALL WIRE SHALL BE 12 1/2 GAUGE AND MUST MEET ASTM SPEC. A-121.
7. NOTICE SIGNS TO BE INSTALLED AT ALL ROADWAY INSTALLATIONS ON PROPERTY OWNED BY CENTERPOINT ENERGY. TO INSTALL NOTICE SIGN USE ASSEMBLY UNIT [SBNTACM].
8. POSTS ARE TO BE TAMPED WITH NATIVE BACKFILL.
9. BARBLESS WIRE TO BE USED WITHIN INCORPORATED CITY LIMITS.
10. BRACE WIRES ARE TO BE WRAPPED TWICE AROUND POSTS, PULLED, AND STAPLED.
11. WHEN DEADENDING WIRE, PULL UNDER FULL TENSION, WRAP TWICE AROUND POST, THEN TWICE AROUND WIRE, AND STAPLE SEVERAL PLACES ON POST.
12. ALL NUTS ON GATE BOLTS SHALL BE WELDED OR GATE BOLTS STRIPPED TO PREVENT REMOVAL.
13. WIRE SPACING MAY VARY IN ORDER TO BE COMPATIBLE WITH EXISTING FENCE.

3	02-27-06	REDRAWN FOR NEW 24' DESIGN	RJR	RJR	MJP	DRAWN	02-03-99	RJL/OUTTRCK
2	04-10-00	REPLACED FARM GATE W/ TUBE GATE	ERS	RJR	MJP	CHECK	02-03-99	RJL/OUTTRCK
1	04-08-99	WOODED ROW TO ONSHREV Y.BLOCK	RJR	RJR	MJP	CERR	02-03-99	RJL/OUTTRCK
NO.	DATE	REVISION	BY	CHK	APP	APPR	02-04-98	MJL/PAMELDS

GATES & CULVERTS		
Sheet 24 of 36		
SCALE: NTS	SHEET 2 OF 2	GC3GATE

SPECIFICATION			
SHEET 23 of 35 SHEETS			
SPEC ID	007	231	79

CENTERPOINT ENERGY
TRANSMISSION STANDARD

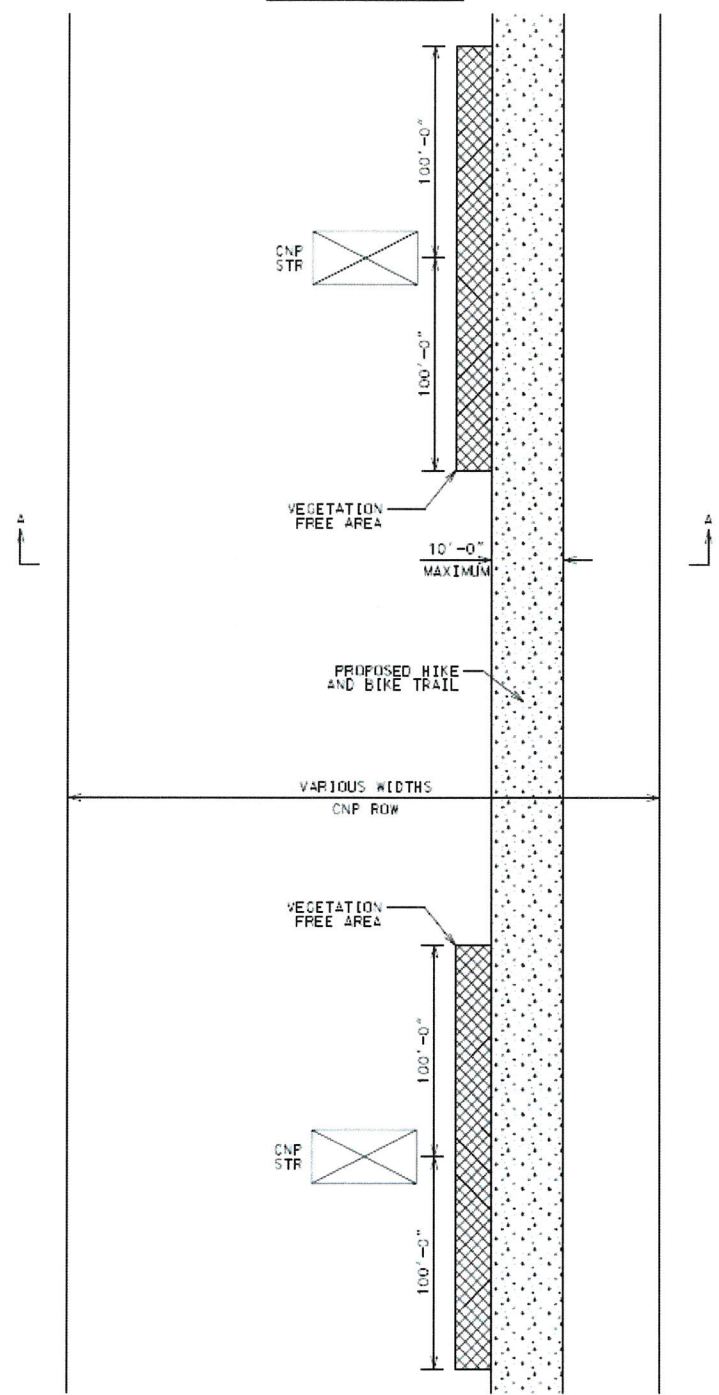

HIKE AND BIKE TRAILS	
MINIMUM STANDARDS	
SCALE: NTS	SHEET 1 OF 2

NO.	DATE	REVISION	BY	CHK	APP	APPR	DRAWN	01-20-14	C. GREEN
							CHECK	01-21-14	D. KLAMF
							CORR	02-04-14	C. GREEN
							APPR	02-24-14	J. DODGE

SPECIFICATION			
SHEET	24	of	35 SHEETS
SPEC ID	007	231	79

12.1 SCOPE

- a. This specification covers the furnishing of labor, material, equipment, permits and supervision necessary for the installation of flexible base road and yard paving on CenterPoint Energy's property.

12.2 GENERAL

- a. The paving work shall be done in accordance with the CenterPoint Energy's Purchase Order, CenterPoint Energy's drawings, CenterPoint Energy's Job Specifications, General Conditions for Construction (CenterPoint Energy's Specification 007-231-79), this specification, the Texas Highway Department Standards (THD), American Society for Testing Materials Standards (ASTM), and the American Wood Preservers Association Standards (AWPA).
- b. In case of conflict, the order of precedence shall be the CenterPoint Energy's Purchase Order, CenterPoint Energy's Job Specification, CenterPoint Energy's drawings, this Specification, the General Conditions for Construction, and the THD, ASTM and AWPA Specifications.
- c. The equipment for proper prosecution of the work shall be at the work site and approved by the CenterPoint Energy's Representative prior to the beginning of construction operations.
- d. The Contractor shall maintain on the job site, at all times, a complete and readable copy of all specifications and any drawings provided by CenterPoint Energy governing the subject paving installation.
- e. No deviation from this specification will be permitted without authorization from CenterPoint Energy.

12.3 MATERIAL ESTIMATES

- a. The quantities indicated on the CenterPoint Energy's drawings are estimated by CenterPoint Energy utilizing plan dimensions, and shall be verified by the Contractor. If the Contractor detects any discrepancies in the quantities estimated by CenterPoint Energy, he should amend the figures on the inquiry sheet to reflect the quantities he has estimated. The quantities shown on the inquiry sheet by CenterPoint Energy, or as amended by the Contractor, shall be the quantities which appear on the purchase order when issued and will be the quantities for which the Contractor will be paid.

SPECIFICATION			
SHEET	26	of	35 SHEETS
SPEC ID	007	231	79

12.4 SCHEDULING

- a. The Contractor shall state in his proposal the number of working days required to complete the job.
- b. The Contractor shall give CenterPoint Energy notice 72 hours prior to the start of construction.
- c. All work shall be performed between the hours of 7:00 a.m. to 7:00 p.m. Work shall not be performed on Saturdays or holidays without a 48 hour advance approval by CenterPoint Energy. Work shall not be performed on Sundays.

12.5 GRUBBING AND EXCAVATION

- a. The area to be paved shall be excavated and shaped to conform with the typical sections shown on the paving drawing.
- b. The area to be paved shall be “cleared and grubbed” removing and disposing of all trees, stumps, brush, roots and stripped of all vegetation, logs, rubbish and other undesirable matter to a depth of four (4) inches.
- c. Very soft or unstable soils that are deemed unfit due to high humus content, high water content, low density, etc., shall be removed to a depth determined by CenterPoint Energy.
- d. All holes, ruts and depressions shall be filled with material approved by the CenterPoint Energy’s Representative.
- e. The Contractor shall not use excavated material as fill material without specific authorization from the CenterPoint Energy’s Representative.
- f. The Contractor shall exercise care when grading, to stay clear of power lines, structures, pipes, septic tanks, fences or any underground facilities installed prior to the road and/or paving construction.
- g. The Contractor shall reimburse CenterPoint Energy for the repair or replacement of any of the previously mentioned equipment he damages.

12.6 SELECT FILL MATERIAL

- a. Select fill material shall conform to a CL (clay) or SM (sand) soil classification designated in ASTM D-2487 unless otherwise approved by the CenterPoint Energy’s Representative.

SPECIFICATION			
SHEET	27	of	35 SHEETS
SPEC ID	007	231	79

- b. Select fill material shall meet the following Atterberg limits:

Class A Fill Material

Liquid Limit 30-45
Plasticity Index 7.5 – 15

Class B Fill Material

Maximum Liquid Limit 35
Maximum Plasticity Index 20

12.7 SOIL STERILANTS

- a. When required, Krovar-1 and Dowpon soil sterilants shall be applied to the area to be paved at the rate of 30 lbs. of Krovar-1 and 30 lbs of Dowpon in 200 gallons of water per acre.
- b. The soil sterilants shall be applied by a state licensed applicator.
- c. The Contractor shall notify the CenterPoint Energy's Representative 48 hours prior to applying soil sterilants so that spraying operation may be inspected.
- d. Failure to abide by this shall be cause for the Contractor to re-spray the designated area at his expense.

12.8 CEMENT STABILIZED SOIL

- a. Soil that CENTERPOINT ENERGY requires to be stabilized with cement shall be done in accordance with THD Standards, Item 270.
- b. The entire area shall be stabilized to the depth shown on the CenterPoint Energy's paving drawings prior to the placement of the fill material.
- c. The amount of Portland cement will be specified by CenterPoint Energy as required by the soil conditions.
- d. The Contractor shall assume full responsibility for damage resulting from cement that has washed or blown off the subgrade.

SPECIFICATION			
SHEET	28	of	35 SHEETS
SPEC ID	007	231	79

12.9 LIME STABILIZED SOIL

- a. Soil that CenterPoint Energy requires to be stabilized with lime shall be done in accordance with THD Standards, Items 260 and 264.
- b. The lime shall be furnished and spread as dry lime.
- c. The road and yard areas shall be stabilized to the depth shown on the paving drawings upon completion of grubbing operations and prior to the placement of any select fill.
- d. The amount of lime stabilization will be specified by CenterPoint Energy as required by the soil conditions.
- e. Sprinkling may be employed to reduce dusting problems during spreading, but excessive wetting of the lime shall be avoided until mixing operations commence.
- f. The Contractor shall assume full responsibility for damages resulting from lime that has washed or blown off the subgrade.

12.10 COMPACTION REQUIREMENTS

- a. All select fill material, stabilized soil, existing yard paving and excavated areas shall be compacted to 95% density as established by the Standard Proctor Density Test with moisture content within 2% optimum.
- b. The select fill material shall be compacted in lifts not to exceed eight (8) inches.
- c. The CenterPoint Energy's Representative shall approve the equipment the Contractor proposes to use for compaction of the fill material.
- d. CenterPoint Energy will check the in-place density using Nuclear Test Methods.

12.11 FORMING

- a. The forms for the paving shall be constructed of Southern yellow pine treated with pentachlorophenol.
- b. The pentachlorophenol solution shall be in accordance with AWPA P8 and AWPA P9, and shall contain a minimum of 5% pentachlorophenol by weight as determined by AWPA A5.
- c. The preservative treatment shall be by the Empty-Cell Process in accordance with AWPA C1 and C2.

SPECIFICATION			
SHEET	29	of	35 SHEETS
SPEC ID	007	231	79

- d. The lumber shall be treated to 0.40 pounds per cubic foot final net retention of pentachlorophenol by assay.
- e. The forms shall be installed in accordance with the plans and shall be true in both horizontal and vertical planes.
- f. The forms shall be of the size, shape and type indicated on the plans.
- g. Forms and stakes shall be of sound heartwood and shall be free of knots, clustered birdseye, checks, splits, and sapwood. Occasional sound or hollow birdseye when not in clusters will be permitted, provided the board is free from any other defects that will impair its usefulness as a form.
- h. Any forms damaged beyond repair due to the Contractor's negligence shall be replaced at his expense.

12.12 CONCRETE PIPE

- a. All concrete pipe shall be constructed in accordance with ASTM C-14, Tongue and Groove.
- b. All reinforced concrete pipe shall be constructed to comply with ASTM C-76, Class IV, Wall B, Reinforced Concrete Pipe.

12.13 GRASS SEEDING

- a. The substation site shall be seeded with hulled Bermuda at the rate of 110 pounds per acre. Gulf Coast Rye shall also be planted with the Bermuda when the ground is 70°F or below. When Bermuda and Gulf Coast Rye are planted together they shall be proportioned as follows:

Bermuda: 50 pounds per acre
 Gulf Coast Rye: 100 pounds per acre

- b. Seeding shall not be performed when the wind velocity would be detrimental to the uniform distribution of the seed.
- c. The area to be seeded shall be lightly raked to provide a seed bed.
- d. The required seed mixture shall be sown uniformly in accordance with the Manufacturer's recommendations.
- e. After sowing, the area shall be evenly raked to provide cover for the seeds.
- f. The lawn area shall be watered in a manner so as not to cause surface erosion.

SPECIFICATION			
SHEET	30	of	35 SHEETS
SPEC ID	007	231	79

12.14 AGGREGATES

- a. The aggregates for the base and sub-base shall consist of one or more of the following: shell, sand, gravel, limestone, or granite gravel.
- b. The aggregates when properly slaked and tested shall conform to the following size requirements:

<u>AGGREGATE TYPE</u>	<u>U.S. STANDARD SIEVE SIZE</u>	<u>PERCENT RETAINED BY WEIGHT</u>	<u>MAX. LIQUID LIMIT</u>	<u>MAX. PLASTIC INDEX</u>
Oyster Shell	2"	0-12%	35	12
	7/8"	12-37%		
	No. 40	50-85%		
	No. 200	88-100%		
Sand	No. 10	0-5%	--	--
	No. 20	5-20%		
	No. 50	75-90%		
	No. 100	95-100%		
Gravel	1 3/4" Screen	0-10%	35	12
	No. 4	30-75%		
	No. 40 Mesh Sieve	70-85%		
Shell and Sand	1 3/4 " Sieve	0-10%	35	12
	No. 4 Sieve	40-65%		
	No. 40 Sieve	50-75%		
Limestone	1 3/4" Sieve	0	40	12
	3/4" Sieve	15-45%		
	No. 4 Sieve	45-75%		
	No. 40 Sieve	60-85%		
Granite Gravel	3/8" to 3/4" Sieve	10-15%	32	14
	No. 4	15-25%		
	No. 8	40-55%		
	No. 16	55-70%		
	No. 40	65-90%		

- c. Local material suppliers shall be approved by CenterPoint Energy.
- d. The aggregate shall be free from excess salt, alkali, vegetable matter, clay or otherwise objectionable matter.

SPECIFICATION			
SHEET	31	of	35 SHEETS
SPEC ID	007	231	79

- e. At the discretion of CenterPoint Energy, the following THD test methods will utilized to verify compliance with these specifications:
 1. Tex-101-E, Preparation of Soil & Flexible Base material for Testing
 2. Tex-104-E, Liquid Limit
 3. Tex-106-E, Plastic Index
 4. Tex-110-E, Sieve Analysis

12.15 CEMENT

- a. Cement shall be Type 1 of a standard brand of Portland cement and shall conform to the requirements of ASTM C-150.

12.16 GROUND BOXES

- a. Ground boxes will be set by CenterPoint Energy before final grading. The Contractor shall set the ground boxes to finish grade.
- b. The Contractor shall set ground boxes to grade over base line monuments.

12.17 STABILIZED BASE COURSES

- a. The approximate combination of aggregates stabilized with Portland cement or flue dust may be provided for the base or subbase in accordance with the following percent mixtures:

<u>Cement-Dual Base</u>		<u>Cement-Tri-Base</u>		<u>Flue Dust-Dual Base</u>	
Oyster Shell	60%	Oyster Shell	30-55%	Oyster Shell	60%
Sand	33%	Gravel	18-35%	Sand	33%
Cement	7%	Sand	35-45%	Flue Dust	7%
		Cement	1.17-7%		

- b. The percent of Portland cement in the Cement-Dual Base and the percent of flue dust in the Flue Dust-Dual Base shall be to the exact proportion give n above.
- c. The percent of Portland cement in the Cement-Tri-Base will range from 1.17-7%, with the actual proportion given in the CenterPoint Energy purchase order.
- d. The Portland cement or flue dust stabilized base courses shall not be mixed or placed when the air temperature is 40°F (or below) and falling.

SPECIFICATION			
SHEET	32	of	35 SHEETS
SPEC ID	007	231	79

12.18 MIXING

- a. The cement, aggregate and water shall be thoroughly mixed in a pugmill type mixer approved by CenterPoint Energy.
- b. The plant shall be equipped with feeding and metering devices which will add the aggregate, cement or flue dust and water into the mixer in the specified quantities.
- c. The moisture content of the mixture shall be maintained between optimum moisture and two percentage points above optimum moisture to protect against dehydration during shipment.
- d. The optimum moisture content and desirable density shall be determined by the Texas Highway Department test Method Tex-114-E, latest revision, and checked in the field by the Nuclear Method.

12.19 CONSTRUCTION METHODS

- a. The Contractor shall apply the base in lifts of not more than 6" or less than 3".
- b. After each lift is spread, it shall be sprinkled and rolled to secure maximum compaction with succeeding layers placed similarly until the course is completed. The material shall be tamped with floats and/or rolled with a roller weighing not less than three (3) tons.
- c. All areas and "nests" of segregated coarse or fine material shall be corrected or removed and replaced with well-graded material, then be sprinkled as required and rolled until a uniform compaction is secured.
- d. All irregularities, depressions or weak spots which develop shall be corrected immediately by scarifying the areas affected, adding suitable material as required, reshaping and recompacting.
- e. When the uncompacted stabilized base mixture is wetted by rain so that at the time of final compaction the average moisture content exceeds the range specified in the test, the entire section shall be removed or additional stabilizer shall be added at the Contractor's expense.
- f. The stabilized base shall be compacted to a density of not less than 95 percent of compaction ratio density as established by the Standard Proctor Density Test. After completion of compaction, the surface that forms the ramp shall be thoroughly wetted and slush rolled to work sufficient mortar to the surface to provide a broom finish for the ramp.

SPECIFICATION			
SHEET	33	of	35 SHEETS
SPEC ID	007	231	79

- g. Prior to each day's construction, a straight joint shall be formed by cutting back into the entire depth of completed work to form a true vertical face free of loose and shattered material.
- h. The stabilized base shall be protected against rapid drying for a period not less than three days.
- j. After the final course of the stabilized base is compacted, the surface shall be finished to grade and section by blading and shall be sealed with approved pneumatic tire or flat wheel rollers.
- k. The finished shape of the course shall be smooth and conform to the typical sections shown on plans, and to the established lines and grades. The surface shall be finished to a tolerance of 1/2 inch in ten (10) feet under a straight edge.
- l. Not more than two (20) hours shall elapse between the start of mixing and the time of starting the compaction of the stabilized base on the prepared subgrade.
- m. The compaction shall be completed within six (6) hours of the time water is added to the mixture.
- n. The CenterPoint Energy's Representative may at his/her option reject any stabilized material that is not in accordance with this specification.
- o. The Contractor shall erect and maintain sufficient barricades to prevent traffic on the newly paved area(s) for a period of 72 hours.

12.20 GRADING

- a. The Contractor shall surface grade the entire substation property including drainage facilities to provide a smooth finish and good drainage.
- b. In the event the paving installation is performed in two phases, the Contractor shall surface grade the substation area after each phase.
- c. When grading, it shall be the Contractor's responsibility to stay clear of power lines and structures. When pipes, septic tanks, or any other underground facilities have been installed prior to road and paving construction, care shall be taken to avoid damage during construction. If these structures are damaged due to the Contractor's negligence, they shall be replaced at his expense.

SPECIFICATION			
SHEET	34	of	35 SHEETS
SPEC ID	007	231	79

12.30 JOB COMPLETION

- a. The Contractor shall remove all debris, scrap material, broken asphalt or concrete and any other objectionable material.
- b. Private property that was damaged during construction shall be repaired, replaced or otherwise corrected at the Contractor's expense.
- c. The unpaved areas shall be sufficiently smooth to allow machine mowing and drainage of all areas.
- d. All clean-up work and surface grading shall be complete before the final inspection by the CenterPoint Energy's Representative.

SPECIFICATION			
SHEET	35	of	35 SHEETS
SPEC ID	007	231	79