

June 4, 2020

Fort Bend County  
301 Jackson Street  
Richmond, TX 77469

**RE: Consent to Encroach to Fort Bend County to construct a roadway within/across CenterPoint Energy Houston Electric, LLC's Hiram Clarke – Juliff Right of Way; TMap: A308; Job# 140478; TR190052**

Mr. KP George:

Attached is a copy of the Consent to Encroach document for execution. The instrument must be executed by a president, vice president or board approved member and properly notarized. Please return (1) original along with a check in the amount of \$5,500.00, payable to CenterPoint Energy Houston Electric, LLC, to me at the address below. Once fully executed, a recorded copy will be returned to you and construction may begin on your project.

As specified in the Construction Specification, please notify the Company Representative seven (7) days prior to any construction activities and keep a copy of this instrument on site at all times.

If you have any questions, please contact me at 713-207-7938.

Regards,

Jasmine Brown  
Associate Right of Way Agent – Land Use  
Land Management Division  
CenterPoint Energy Houston Electric, LLC

Enclosures

**By Mail:**

CenterPoint Energy  
P.O. Box 1700  
Houston, Texas 77251-1700  
**Attn:** Jasmine Brown CNPT 701C

**By Courier:**

CenterPoint Energy  
1111 Louisiana  
Houston, Texas 77002  
**Attn:** Jasmine Brown CNPT 701C

52N



### CONSENT TO ENCROACH

**NOTICE OF CONFIDENTIALITY RIGHTS: IF YOU ARE A NATURAL PERSON, YOU MAY REMOVE OR STRIKE ANY OR ALL OF THE FOLLOWING INFORMATION FROM ANY INSTRUMENT THAT TRANSFERS AN INTEREST IN REAL PROPERTY BEFORE IT IS FILED FOR RECORD IN THE PUBLIC RECORDS: YOUR SOCIAL SECURITY NUMBER OR YOUR DRIVER'S LICENSE NUMBER.**

STATE OF TEXAS        }  
  }  
COUNTY OF FORT BEND}

KNOW ALL PERSONS BY THESE PRESENTS:

WHEREAS, Fort Bend County (hereinafter referred to as "Grantee") has requested consent to encroach within easements located within a certain 80.369 – acre tract of land situated in the Elijah Roark Survey, Abstract 77, Fort Bend County, Texas, being the same property described in a deed to Woodmere Development, and recorded under County Clerk's File 2014039314 of the Official Public Records of said County and State; and a certain 259.7066 – acre tract of land situated in the Thomas Habermacher Survey, Abstract 191, Fort Bend County, Texas, being the same property described in deeds to Teletower, and recorded in Volume 1048, Page 276 and Volume 1048, Page 288 of the Deed Records of said County and State.

WHEREAS, the above described properties are subject to easements recorded in Volume 614, Page 3 and Volume 614, Page 6 of the Deed Records of Fort Bend County, Texas (hereinafter referred to as "Easement Area") created in favor of CenterPoint Energy Houston Electric, LLC, a Texas limited liability company or the legal antecedent entity for the erection and maintenance of electric transmission lines and appurtenances across, over, along, upon and under said property; and

WHEREAS, Grantee has requested consent for the installation, construction, maintenance, and removal of a road, consisting of all necessary and desirable equipment and appurtenances, (hereinafter referred to as "Grantee's Facilities") within said Easement Area.

NOW, THEREFORE, KNOW ALL MEN BY THESE PRESENTS that CenterPoint Energy Houston Electric, LLC (hereinafter referred to as "Grantor" and which term also includes their affiliates, successors and assigns), hereby consents to Grantee's Facilities over, across, or within said Easement Area, as illustrated on the attached certified survey labeled **EXHIBIT "A"**.

Grantee its successors, assigns, agents, and licensees, are forever subject to all the provisions stated herein:

**I. TERMS, CONDITIONS AND OBLIGATIONS:**

- A. In the event that Grantee's Facilities change ownership through its successors, and assigns, by a merger, acquisition, or corporate name change, Grantee shall notify Grantor in writing within sixty (60) days of said change in the manner

provided in **Section VII. Notices**. Grantee shall pay to Grantor, Grantor's then current processing fee for each change notification.

- B. Grantee, its successors and assigns shall forever be solely responsible for the installation, construction, maintenance, and removal of Grantee's Facilities.
- C. Grantee's Facilities shall be installed, at its own cost and expense, as shown on said attached **EXHIBIT "A"**. If at a later date any of Grantee's Facilities are found existing outside the locations and elevations shown on said attached **EXHIBIT "A"**, then Grantee will, at its own cost and expense, relocate Grantee's Facility to its proper location to occur within ninety (90) days of any formal notice of incorrect placement. **IN THE EVENT ANY PORTION OF GRANTEE'S FACILITIES REMAIN OUTSIDE OF THE LOCATION APPROVED BY GRANTOR, GRANTEE HEREBY AGREES TO FORFEIT ANY AND ALL RIGHT OR CAUSES OF ACTION TO CLAIM A PRESCRIPTIVE EASEMENT OR EXERCISE ADVERSE POSSESSION OR EMINENT DOMAIN, AGAINST GRANTOR OR ANY PORTION OF THE EASEMENT AREA.**
- D. It is understood and agreed that Grantor has no right to grant an easement (not being the owner of fee title) but herein may consent to construction of Grantee's Facilities so far as its interests appear, Grantor hereby grants such permission. Grantee shall obtain all necessary rights of way and easements from the underlying fee owners of the land on which the Easement Area is located before conducting any construction operations thereon.

## II. CONSTRUCTION REQUIREMENTS:

- A. Grantee, its contractors and subcontractors are forever subject to all terms, conditions and construction requirements set out in Grantor's Specification for Construction on CenterPoint Energy Property, as they apply to Grantee's Facilities upon the Easement Area, a copy of which is attached hereto and made a part hereof as **EXHIBIT "B"**, and is hereinafter referred to as the "Specifications".
- B. Grantee shall not install any additional equipment of any type or character on the Easement Area without formal written approval by Grantor. Any future plans to install any other equipment of any type or character separate from the installations permitted under this Consent to Encroach as described on said attached **EXHIBIT "A"** must be submitted to Grantor for review and approval prior to any construction.
- C. Grantee shall reimburse Grantor, within thirty (30) days after receipt of notice from Grantor, for the cost of any and all temporary or permanent alterations and the repair or replacement of any and all damages to Grantor's facilities, which may be comprised of, but not limited to, electric transmission and distribution lines, foundations, telecommunication lines, electrical substation facilities, whether one or more, consisting of a variable number of wires, conduits, cables and all necessary or desirable equipment and appurtenances, towers or poles made of wood, metal or other equipment, materials, props and guys, hereinafter referred to

as the "Grantors Facilities", caused by these installations and/or alterations. Grantee further agrees to reimburse Grantor for any and all cost incurred by Grantor due to the installation and/or alterations of Grantee's Facilities within the Easement Area.

- D. During any type of construction or repair activities, Grantee shall not use the Easement Area as a "Show Up/Project Staging Area" without prior written consent of Grantor. Show Up/Project Staging Area for all purposes herein shall mean a site or area where vehicles, freight haulers, supplies, materials, workers, construction support, and any other equipment, machinery or persons of like kind are placed or positioned for use, mobilization and access to a construction site or linear project.
- E. Notwithstanding the restoration provisions as stated in the Specifications Item No. 3.0.e, Grantee shall adhere to the following provisions:
  - 1. The natural drainage pattern of the Easement Area shall be maintained and all previously existing ditches, culverts, fences, roads and driveways, if damaged by Grantee, shall be re-established to the condition existing prior to Grantee's work within fourteen (14) days after the installation, construction, maintenance, and/or removal of Grantee's Facilities.
  - 2. Grantee shall restore the Easement Area, including but not limited to, any additional back filling of all compacted pipeline trenches as many times deemed necessary by Grantor's inspectors or the repair of fences or culverts, within fourteen (14) days after the installation, construction, maintenance, and/or removal of Grantee's Facilities.
  - 3. All trash or any other materials which are deemed objectionable to Grantor, at its sole discretion, resulting from Grantee's construction activities shall be removed from the Easement Area by Grantee within fourteen (14) days after the installation, construction, maintenance, and/or removal of Grantee's Facilities.
- F. If Grantee violates any of the provisions contained herein, in the sole discretion of Grantor or any of Grantor's authorized agents, then Grantor and/or its authorized agents are fully authorized to stop any and all work in progress on the Easement Area until Grantee corrects such violation and modifies its procedures in a manner acceptable to Grantor.
- G. Grantee hereby guarantees all work performed by Grantee and its contractors and subcontractors against any and all defects in workmanship and shall, at its sole cost and expense, make repairs as deemed necessary by Grantor to remedy such defects within fourteen (14) days after demand.
- H. Grantee agrees not to install lighting or signs within the Easement Area.

### III RESERVATIONS:

- A. Grantor hereby reserves for itself, its successors, assigns and licensees, the right to use the Easement Area for any purpose and in any manner, including, but not limited to, the right to construct, or to permit and/or grant to others the right to construct pipelines along side of, under and adjacent to Grantee's Facilities, the right to cross or to permit and/or grant to others the right to cross under or over Grantee's Facilities with other facilities, which includes, but is not limited to, pipelines, roads, streets, railroads, water lines, sewer lines, parking lots, telecommunication infrastructure and other utilities or facilities, along with rights to install, maintain, repair, replace and remove said facilities. All pipelines shall be constructed in such a manner that encasements shall not be required for parking lot uses.
- B. In the event that the existence, construction, operation, maintenance, relocation, or removal of Grantee's Facilities, within the Easement Area causes Grantor to incur any costs that in any manner relate to Grantor's construction, installation, operation, maintenance, removal, repair, replacement, protection, alteration, or relocation of Grantors Facilities, Grantee shall reimburse Grantor, within thirty (30) days after receipt of notice from Grantor, for any and all such costs that would not have been incurred but for the existence of Grantee's Facilities. In lieu of said cost reimbursement, Grantee shall have the option to relocate Grantee's Facilities at Grantee's sole cost and expense, subject, however, to Grantor providing a site for such relocation, at Grantor's sole discretion, and provided that Grantor shall furnish Grantee a substitute consent covering any such new locations within the Easement Area.
- C. Grantor herein expressly reserves unto itself, any and all interest in and to the Easement Area except for the rights and privileges to the portion of the Easement Area for Grantee's Facilities, as set forth herein. Nothing herein shall prevent Grantor from transferring or encumbering any interest in the Easement Area or any portion thereof. **GRANTEE ACKNOWLEDGES THAT GRANTOR HAS NOT MADE AND DOES NOT MAKE ANY REPRESENTATIONS AS TO THE PHYSICAL CONDITION, OR ANY OTHER MATTER AFFECTING OR RELATED TO THE EASEMENT AREA. GRANTEE EXPRESSLY AGREES THAT TO THE MAXIMUM EXTENT PERMITTED BY LAW, THIS CONSENT TO ENCROACH FOR GRANTEE'S FACILITIES WITHIN THE PORTION OF EASEMENT AREA IS GRANTED "AS IS" AND "WITH ALL FAULTS", AND GRANTOR EXPRESSLY DISCLAIMS, AND GRANTEE ACKNOWLEDGES AND ACCEPTS THAT GRANTOR HAS DISCLAIMED, ANY AND ALL REPRESENTATIONS, WARRANTIES OR GUARANTIES OF ANY KIND, ORAL OR WRITTEN, EXPRESS OR IMPLIED, CONCERNING THE EASEMENT AREA, INCLUDING WITHOUT LIMITATION, THE VALUE, ENVIRONMENTAL AND PHYSICAL CONDITION, MERCHANTABILITY, HABITABILITY, MARKETABILITY, PROFITABILITY, SUITABILITY OR FITNESS FOR A PARTICULAR USE OR PURPOSE, OF THE EASEMENT AREA AND THAT THE GRANTEE HAS RELIED EXCLUSIVELY ON ITS OWN INSPECTION AND INVESTIGATION OF THE EASEMENT AREA IN DECIDING TO REQUEST THE RIGHTS GRANTED**

HEREUNDER.

- D. GRANTEE HEREIN ACKNOWLEDGES THAT WITHIN THE EASEMENT AREA, GRANTORS RIGHTS ARE DOMINANT AND PREVAILING OVER GRANTEE'S RIGHTS IN ALL CASES. GRANTOR HEREIN EXPRESSLY RESERVES UNTO ITSELF, ITS SUCCESSORS, ASSIGNS AND CONTRACTORS ANY AND ALL RIGHTS OF OPERATIONS, MAINTENANCE, FOUNDATION REINFORCEMENTS, NEW FOUNDATIONS AND NEW CONSTRUCTION ON, OVER, UNDER AND NEXT TO GRANTEE'S FACILITIES AND THAT GRANTEE'S SIGNATURE HEREINBELOW DOCUMENTS GRANTEE'S ACKNOWLEDGEMENT OF NOTICE OF SUCH ACTIVITIES.

#### IV. INSURANCE:

As a requirement for the Consent to Encroach to be granted, Grantee shall forever carry for the benefit of Grantee and Grantor the minimum insurance coverage as noted on **EXHIBIT "C"**, Minimum Insurance Requirements, attached hereto and made a part hereof. Grantee shall (i) be solely responsible for the costs, expenses and premiums of all policies of insurance which are required herein, (ii) cause Grantor to be named as an additional insured under all such policies for the purposes set forth herein, and (iii) provide that such insurance may not be cancelled or changed except upon fifteen (15) days prior written notice to Grantor. Grantee shall furnish Grantor evidence of such liability insurance coverage prior to the commencement of any work or any other activities on Grantor's Property.

#### V. ENVIRONMENTAL:

- A. Should Grantee, its contractors and subcontractors, allow or cause to occur at any time, a spill, leak or discharge ("Discharge"), upon the Easement Area, of any substance, which any law or regulation requires reporting to a governmental agency, then Grantee shall have an affirmative obligation to report said Discharge to the Land Management Division of Grantor within three (3) days of the discovery of such Discharge, in the manner provided in **Section VII. Notices**. A penalty of Ten Thousand Dollars (\$10,000.00) shall be assessed against Grantee for each and every failure to notify Grantor of said Discharge. In the event Grantee fails to pay Grantor said penalty within thirty (30) days after receipt of invoice, then Grantor may, at its sole discretion, terminate this Consent to Encroach upon written notice to Grantee, without further liability to Grantor and may exercise any and all rights available to Grantor at law and/or equity.
- B. Grantee shall be solely responsible for all costs and expenses to install and forever maintain Grantee's Facilities including, but not limited to, obtaining any and all required environmental studies and permits, and pay any and all payments, including but not limited to governmental fees, assessments, taxes, permits, and all other licenses, fees or permits. It is the responsibility of the Grantee's to conduct any necessary studies that may be required by state or federal regulations for the protection of cultural resources, archeological sites and threatened and endangered plants and animals. Prior to construction, Grantee's shall identify any

of the following encountered along the proposed project route as specified in Item 11.0 of the Specifications: (1) known or potential archeological or historical site(s), and (2) known locations or habitats of endangered and threatened species. All costs for initial studies, additional investigations and mitigative measures shall be the sole obligation of the Grantee.

## VI. FIBER OPTICS:

In the event Grantor's Fiber Optic Cable System is within the area of work, the following conditions must be adhered to as a minimum:

- A. Maintain a minimum of 2'-0" vertical separation between Grantors fiber optic cable conduits and Grantee's Facilities.
- B. Maintain a minimum of 5'-0" horizontal separation from the outer most limits of Grantee's Facilities to Grantor's fiber optic cable conduits.
- C. Grantee's contractor shall maintain a minimum of 4 to 5 feet horizontal separation from, and use extreme caution when near, Grantor's fiber optic pull holes and cable marker signs in conjunction with the underground fiber optic cable route and develop construction vehicle traffic routes within the Easement Area that will not be in conflict with such devices.
- D. Grantor's fiber optic cable conduits shall be supported during all open trench construction activity.
- E. A damage prevention specialist will be required during any construction across Grantor's underground fiber optic cable and Grantee will be billed on a cost plus basis of \$73.95 plus a 15% administrative fee per hour or the then current standard rate.
- F. Notification shall be given to Grantor's Land Management Division and to the office of Grantors General Counsel, at least forty-eight (48) hours prior to any construction activity in the vicinity of Grantors underground optic cable.

## VII. NOTICES:

- A. Grantee shall give proper notice to Grantor as required in Item No. 3.0.g in the Specifications and to all other parties which have interests within the Easement Area. **(Please refer to TR190052)**
- B. The rights granted through this Consent to Encroach affect only Grantor's interest in the Easement Area. Grantee shall be solely responsible for notifying and securing permission, permits, and approval from all parties having property rights or an interest on, under or above the subject Easement Area ("Interested Parties"). The construction requirements of the Interested Parties shall be observed however, Grantor's Specifications shall be adhered to as a minimum. **GRANTEE, ITS SUCCESSORS, ASSIGNS, AGENTS, EMPLOYEES, CONTRACTORS,**

**SUBCONTRACTORS AND LICENSEES SHALL INDEMNIFY GRANTOR FROM ALL CLAIMS, CAUSES OF ACTION OR DAMAGES WHICH ARISE FROM GRANTEE'S FAILURE TO SECURE THE APPROVAL OF ALL PARTIES WITH AN INTEREST IN THE SUBJECT EASEMENT AREA.**

The following addresses should be used for contact and notification purposes:

GRANTOR'S ADDRESS:

CenterPoint Energy  
P. O. Box 1700  
Houston, TX 77251-1700  
Attn: Land Management

GRANTEE'S ADDRESS:

Fort Bend County  
301 Jackson Street  
Richmond, TX 77469  
Attn: Judge KP George

**VIII. ADDITIONAL TERMS, CONDITIONS AND OBLIGATIONS:**

- A. Grantee shall, at Grantee's sole cost and expense, promptly resolve any complaints or litigation which pertains to Grantee's installation of Grantee's Facilities upon the Easement Area from any and all parties including, but not limited to, area homeowners, businesses, apartments, and lessees to Grantor's satisfaction. Grantee shall also pay all reasonable attorneys' fees incurred by Grantor in regards to any such litigation.
- B. Grantee shall reimburse Grantor for the actual costs incurred as a direct result of on-site supervision for inspection purposes or conflict resolution by Grantor's employees or contract representatives.
- C. Grantee has one year from the execution date of this Consent to Encroach to commence construction of Grantee's Facilities within the Easement Area. If construction has not started within this time period, this Consent to Encroach shall automatically become null and void and terminate.
- D. Grantee must take immediate action to cure all health and safety issues and environmental issues. Further, if Grantee, its contractors and subcontractors, shall at any time fail or refuse to comply with or carry out any of the provisions herein contained, Grantor shall notify Grantee of such infraction in the manner provided in **Section VII. Notices**. In the event such failure or refusal shall continue for a period of ninety (90) days after receipt of said demand to comply, Grantor may terminate this Consent to Encroach upon written notice to Grantee. If Grantor terminates this Consent to Encroach, then Grantee shall, at Grantee's sole cost and expense, cease all operations, remove Grantee's Facilities, and restore the Easement Area to the condition which existed prior to Grantee's construction activities. Should Grantee fail to remove Grantee's Facilities and restore the Easement Area within ninety (90) days after termination of the Consent to Encroach, Grantor may proceed with such work. Grantee shall promptly reimburse Grantor the cost thereof, within thirty (30) days after receipt of billing.

- E. In the event that Grantee shall ever abandon or make idle Grantee's Facilities within the approved area, or any portion thereof, for twelve (12) continuous months, this Consent to Encroach or that abandoned portion of the approved area, shall automatically terminate and all rights hereunder shall thereupon revert to Grantor. Further Grantee shall, at its sole cost and expense, remove Grantee's Facilities from the Easement Area, restoring such premises to the condition existing prior to Grantee's work. In the event Grantee fails to remove Grantee's Facilities and restore the Easement Area within ninety (90) days after termination of the Consent to Encroach, Grantor may proceed with such work and Grantee shall reimburse Grantor the cost thereof, within thirty (30) days after receipt of billing thereof.
- F. This Consent to Encroach is expressly made subject to restrictions, covenants, conditions, limitations, easements and mineral reservations, if any, now in force and existing of record in the office of the County Clerk of the county or counties named herein, to which reference is hereby made for all purposes, and to those easements which, though not of record, are evidenced on the ground.
- G. Grantee agrees to reimburse Grantor for its actual costs incurred (including overtime as applicable), plus an additional 15%, for Grantor's assignment of a sufficient number of on-site inspectors reasonably necessary, in Grantor's sole judgment, for the inspection by Grantor of Grantee's personnel and/or its contract personnel involved in the construction, installation, and/or repair of Grantee's Facilities at any given time. At Grantor's discretion, a minimum of one full time inspector may be on site during all construction activities. Grantor shall invoice Grantee for said inspections on a monthly basis and Grantee shall pay Grantor within thirty (30) days from the date of invoice in the manner provided in **Section VII. Notices.**

#### **IX. INDEMNIFICATIONS:**

**THE INDEMNITIES BELOW SHALL SURVIVE ANY TERMINATION OR ABANDONMENT OF THIS CONSENT TO ENCROACH.**

**GRANTEE SHALL REQUIRE ITS CONTRACTORS, SUBCONTRACTORS AND LICENSEES TO INDEMNIFY AND HOLD GRANTOR HARMLESS FROM AND AGAINST ANY AND ALL CLAIMS, ACTIONS, CAUSES OF ACTION, DEMANDS, LIABILITIES, COSTS, LOSSES, EXPENSES AND DAMAGES, IN CONTRACT, STRICT LIABILITY OR IN TORT, INJURY TO ANY PERSON (INCLUDING DEATH) OR DAMAGE TO ANY PROPERTY ARISING OUT OF, RELATED TO OR IN ANY WAY CONNECTED WITH THE CONSTRUCTION, USE AND EXISTENCE OF GRANTEE'S FACILITIES ON THE EASEMENT AREA WHERE SUCH INJURY OR DAMAGE IS CAUSED BY THE SOLE, JOINT, CONCURRENT, CONTRIBUTING OR COMPARATIVE NEGLIGENCE OR FAULT OF GRANTEE, IT'S AGENTS OR EMPLOYEES. THIS INDEMNITY SHALL BE APPLICABLE WHERE THE INJURY OR DAMAGE IS CAUSED BY THE JOINT, CONCURRENT, CONTRIBUTING BUT NOT THE SOLE NEGLIGENCE OF GRANTOR, ITS AGENTS OR EMPLOYEES.**

GRANTEE SHALL REQUIRE ITS CONTRACTORS, SUBCONTRACTORS AND LICENSEES TO INDEMNIFY AND HOLD GRANTOR HARMLESS FROM AND AGAINST ANY AND ALL CLAIMS, ACTIONS, CAUSES OF ACTION, DEMANDS, LIABILITIES, COSTS, LOSSES, EXPENSES AND DAMAGES, INCLUDING, BUT NOT LIMITED TO, DAMAGES TO REAL OR PERSONAL PROPERTY OR NATURAL RESOURCES, PERSONAL INJURY OR DEATH CLAIMS, AND PUBLIC OR PRIVATE CLAIMS OR DEMANDS FOR DIRECT PAYMENT OR REIMBURSEMENT OF INVESTIGATION, REMEDIATION AND GOVERNMENT OVERSIGHT COSTS, ARISING OUT OF, RELATED TO OR IN ANY WAY CONNECTED WITH THE PRESENCE OR RELEASE OF HAZARDOUS SUBSTANCES, POLLUTANTS OR OTHER CONTAMINANTS ON, UNDER OR ABOVE THE EASEMENT AREA AND/OR RIGHTS OF WAY DURING OR FOLLOWING THE WORK WHERE SUCH HAZARDOUS SUBSTANCES, POLLUTANTS OR OTHER CONTAMINANTS MIGRATE OR ARE OTHERWISE TRANSPORTED OR RELEASED FROM GRANTEE'S OR ITS AGENT'S OR CONTRACTOR'S EQUIPMENT, FACILITIES, OR ACTIVITIES WITHIN THE EASEMENT AREA.

GRANTEE SHALL REQUIRE ITS CONTRACTORS, SUBCONTRACTORS AND LICENSEES TO INDEMNIFY AND HOLD GRANTOR HARMLESS FROM AND AGAINST ANY AND ALL CLAIMS, ACTIONS, CAUSES OF ACTION, DEMANDS, LIABILITIES, COSTS, LOSSES, EXPENSES AND DAMAGES, ARISING OUT OF, RELATED TO OR IN ANY WAY CONNECTED WITH, ANY LOSS BY GRANTOR OF ANY INTEREST (WHETHER FEE OR ANY OTHER INTEREST) OF THE EASEMENT AREA (EXCEPT AND TO THE EXTENT SPECIFICALLY GRANTED TO GRANTEE HEREIN), INCLUDING WITHOUT LIMITATION, THE EASEMENT AREA AS A RESULT OF OR IN CONNECTION WITH GRANTEE'S USE AND/OR OCCUPANCY OF THE EASEMENT AREA, OR ANY OTHER PORTION OF THE EASEMENT AREA.

ANY EMPLOYEE OF GRANTEE PRESENT ON GRANTOR'S PROPERTY SHALL HAVE THE EXPRESS CONSENT OF GRANTOR AND SIGN A WRITTEN WAIVER OF LIABILITY SATISFACTORY TO GRANTOR PRIOR TO ENTERING GRANTOR'S PROPERTY.

If this Consent to Encroach is not accepted and agreed, notarized and returned by July, 15, 2020 this document shall become null and void.

IN WITNESS WHEREOF, these presents have been executed by CenterPoint Energy Houston Electric, LLC and granted this the 3<sup>RD</sup> day of September, 2020.

**CenterPoint Energy Houston Electric, LLC**

BY: Matthew R Dowell  
Matthew R. Dowell, Manager, Land Management  
CRS Agent & Attorney-in-Fact

**ACCEPTED AND AGREED** to this 28 day of July, 2020.

**Fort Bend County**

BY: KP George  
KP George County Judge

STATE OF TEXAS }

COUNTY OF HARRIS }

This instrument was acknowledged before me on SEPTEMBER 3, 2020, by Matthew R. Dowell, Manager, Land Management Division, as Agent & Attorney-in-Fact of CenterPoint Energy Houston Electric, LLC, a Texas limited liability company, on behalf of said company.

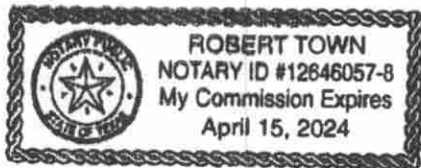

*Robert Town*  
\_\_\_\_\_  
Notary's Signature

STATE OF TEXAS }

COUNTY OF FORT BEND }

This instrument was acknowledged before me on July 28, 2020, by KP George, County Judge of Fort Bend County, acknowledging he has full authority to execute the foregoing document and that he executed the same for the purposes and consideration therein expressed on the behalf of said county.

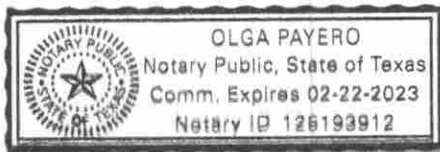

*Olga Payero*  
\_\_\_\_\_  
Notary's Signature

**AFTER RECORDING RETURN TO:**

**LAND MANAGEMENT DIVISION  
CENTERPOINT ENERGY  
P.O. BOX 1700  
HOUSTON, TX 77251-1700**

Exhibit "A"

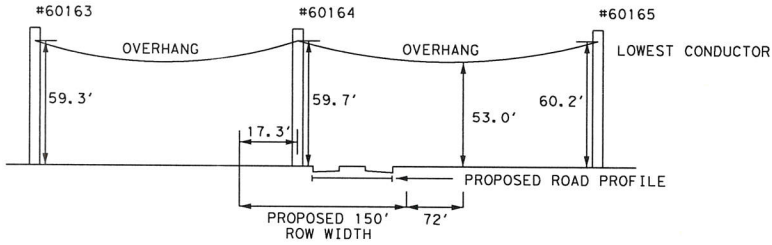

THOMAS HABERMACHER SURVEY  
A-191

TELETOWER  
CALLED 259.7067 AC. TRACT  
DESIGNATED AS TRACT A  
ONE OF TWO TRACTS - EXHIBIT "A", PAGE 1  
VOL. 1048, PG. 288 F.B.C.D.R. (1/2 INT.)  
MAY 06, 1982  
VOL. 1048, PG. 276 F.B.C.D.R. (1/2 INT.)  
MAY 06, 1982

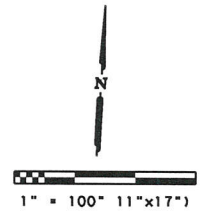

P.O.B.  
X = 3,083,631.57  
Y = 13,765,488.12

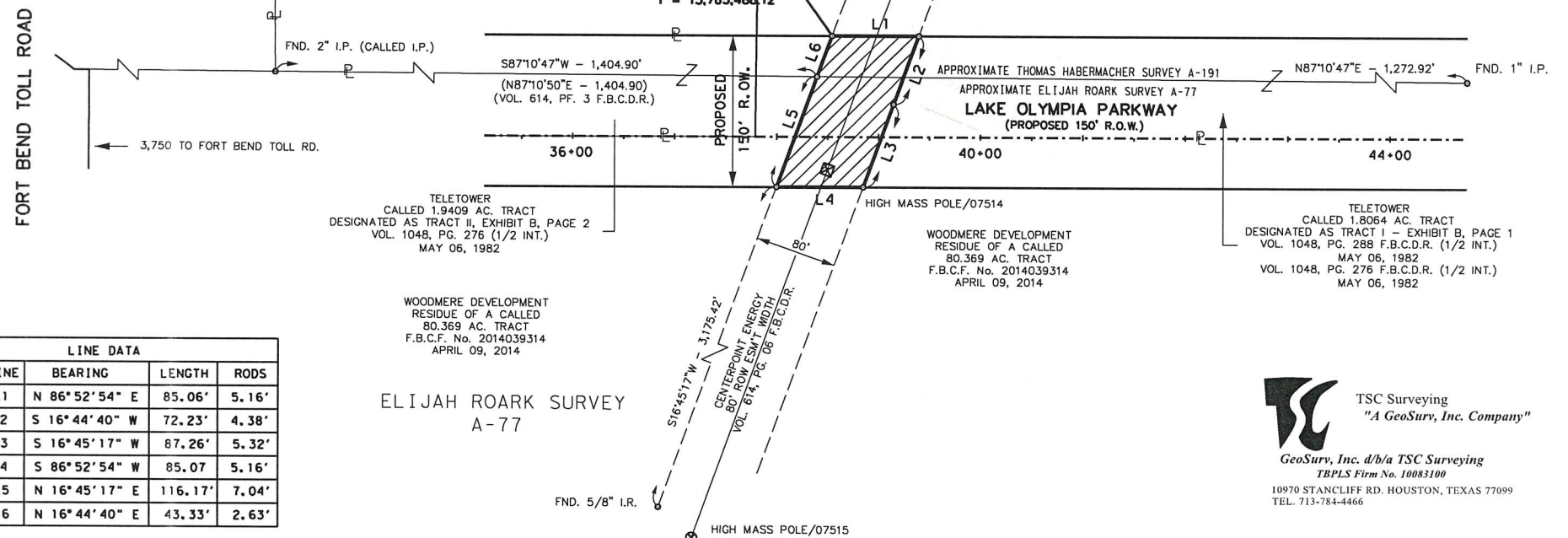

TELETOWER  
CALLED 1,9409 AC. TRACT  
DESIGNATED AS TRACT II, EXHIBIT B, PAGE 2  
VOL. 1048, PG. 276 (1/2 INT.)  
MAY 06, 1982

WOODMERE DEVELOPMENT  
RESIDUE OF A CALLED  
80.369 AC. TRACT  
F.B.C.F. No. 2014039314  
APRIL 09, 2014

WOODMERE DEVELOPMENT  
RESIDUE OF A CALLED  
80.369 AC. TRACT  
F.B.C.F. No. 2014039314  
APRIL 09, 2014

TELETOWER  
CALLED 1,8064 AC. TRACT  
DESIGNATED AS TRACT I - EXHIBIT B, PAGE 1  
VOL. 1048, PG. 288 F.B.C.D.R. (1/2 INT.)  
MAY 06, 1982  
VOL. 1048, PG. 276 F.B.C.D.R. (1/2 INT.)  
MAY 06, 1982

LINE DATA			
LINE	BEARING	LENGTH	RODS
L1	N 86° 52' 54" E	85.06'	5.16'
L2	S 16° 44' 40" W	72.23'	4.38'
L3	S 16° 45' 17" W	87.26'	5.32'
L4	S 86° 52' 54" W	85.07'	5.16'
L5	N 16° 45' 17" E	116.17'	7.04'
L6	N 16° 44' 40" E	43.33'	2.63'

ELIJAH ROARK SURVEY  
A-77

TSC Surveying  
"A GeoSurv, Inc. Company"  
  
GeoSurv, Inc. d/b/a TSC Surveying  
TBPLS Firm No. 10083100  
10970 STANCLIFF RD. HOUSTON, TEXAS 77099  
TEL. 713-784-4466

- NOTES:
1. THE HORIZONTAL CONTROL IS REFERENCED TO THE CONTINUOUS OPERATING REFERENCE STATIONS (C.O.R.S.) NETWORK, NORTH AMERICAN DATUM OF 1983 (NAD 83), TEXAS SOUTH CENTRAL ZONE 4204, EPOCH DATE 2010.00.
  2. DISTANCES SHOWN HERE ON ARE SURFACE AND MAY BE CONVERTED TO GRID BY DIVIDING BY A COMBINED SCALE FACTOR OF 1.00013. (GRID = SURFACE/S.F.)
  3. CENTERPOINT ENERGY MAP REFERENCE: A-308
  4. RODS UNITS ARE SHOWN INSIDE PARENTHESIS.
  5. ORIGINAL ABSTRACTING PERFORMED IN SEPTEMBER OF 2015.

*Daniel Paul Coyer*  
DANIEL PAUL COYER R.P.L.S.  
REGISTERED PROFESSIONAL LAND  
SURVEYOR NO. 4867



10/23/2018  
DPC

TOTAL AREA: 12,760 SQUARE FEET, 0.2929 ACRES

**CENTERPOINT ENERGY  
80' CENTERPOINT ENERGY EASEMENT  
FORT BEND COUNTY, TEXAS**

SCALE: 1 = 100	
DRAWING NO.:	

# SPECIFICATION

**CENTERPOINT ENERGY HOUSTON ELECTRIC, LLC  
P. O. BOX 1700, HOUSTON, TEXAS 77251-1500**

## **A. CONSTRUCTION**

**Reference Drawings:**

**CenterPoint Energy Transmission Standards Manual**

**Drawing No.: 006-203-01**

006-203-02

006-203-04

006-203-07

**GC3GATE**

**Hike and Bike Trail Specification**

**Reference Specifications:**

- CenterPoint Energy #007-229-06
- Texas Health & Safety Code – Chapter 752
- Federal Regulations, Title 29, CFR 1926.651, CFR 1910.333 ASTM C76
- Texas Highway Department Standard Specifications for Construction of Highways, Streets and Bridges: Item 162,Item 164,Item 166
- American Association of State Highway and Transportation Officials (AASHTO) 17<sup>TH</sup> Edition-2002

## **B. SPECIAL AND TECHNICAL CONDITIONS, FLEXIBLE BASE ROAD AND YARD PAVING**

**REFERENCE SPECIFICATIONS:**

Texas Highway Department (THD) Item 260

a/k/a Texas Department of Transportation (TxDOT)

1972 Standards for Construction Item 264

Of Highways, Streets and Bridges Item 270

Texas Highway Department	Tex-101E-1966	ASTM C14-75
Test Methods	Tex-104E-1968	ASTM C76-75
	Tex 106E-1962	ASTM C506-75
	Tex 110 E 1968	ASTM C150-76
	Tex 114E-1965	ASTM D2487-69
	Tex 115E 1962	AWPA C1-73
	Tex-116E 1962	AWPA C2-73
		AWPA A5-76
		AWPA P8-64
		AWPA P9-73

NO.	DATE	REVISION SECTION(S) AFFECTED	BY	CH	APP
1	07/03/86	Created	RDT	RNM	REB
2	05/05/03	Revised all sections	LRS	LRS	MJP
3	02/18/08	Revised all – Split Sec. 9	LRS	LRS	MJP
4	10/20/09	Revised Sect. 4	LRS	LRS	MJP
5	01/19/12	Revised Gate & Access Widths	LRS	LRS	MJP
6	02/10/14	Overall Revision	MDL	LRS	JHD

<b>SPECIFICATION</b>			
SHEET 1 of 35 SHEETS			
SPEC ID	007	231	79

# CONTENTS

<u>Item No.</u>	<u>Title</u>	<u>Page No.</u>
1.0	SCOPE	3
2.0	DEFINITIONS	3
3.0	GENERAL REQUIREMENTS FOR CONSTRUCTION	4
4.0	SPECIAL REQUIREMENTS FOR PIPELINES AND VALVE SITES, COMMUNICATION CABLES AND CABLE TELEVISION INSTALLATIONS	9
5.0	SPECIAL REQUIREMENTS FOR DRAINAGE DITCHES	12
6.0	SPECIAL REQUIREMENTS FOR STREETS AND ROADS, HIKE AND BIKE TRAILS, AND PLAY GROUND EQUIPMENT	12
7.0	SPECIAL REQUIREMENTS FOR SPUR TRACKS	13
8.0	SPECIAL REQUIREMENTS FOR PARKING FACILITIES	13
9.0	SPECIAL REQUIREMENTS FOR NURSERY OPERATIONS	14
10.0	SPECIAL REQUIREMENTS FOR DECORATIVE PLANTING	14
11.0	SPECIAL REQUIREMENTS FOR PROTECTING CULTURAL RESOURCES, ARCHAEOLOGICAL SITES, AND THREATENED AND ENDANGERED PLANTS AND ANIMALS	15
12.0	SPECIFICATION FOR SPECIAL AND TECHNICAL CONDITIONS FLEXIBLE BASE ROAD AND YARD PAVING, #007-229-06	26

SPECIFICATION			
SHEET	2	of	35 SHEETS
SPEC ID	007	231	79

1.0 SCOPE

- a. This specification covers the requirements that a Grantee/Contractor shall adhere to when performing work on the property of CenterPoint Energy.
- b. At the time of this revision, the active Company Representatives for these specifications are:

**Janice Coburn**  
Office 713-207-6138  
Cell 281-460-0635

**Travis Drabek**  
Office 713-207-6480  
Cell 832-623-1326

**D. Scott Humble**  
Office 713-207-6747  
Cell 713-855-7836

**Robert (Bobby) Sloan**  
Office 713-207-4321  
Cell 832-547-5911

2.0 DEFINITIONS

- a. Company – CenterPoint Energy Houston Electric, LLC, which also may be referred to as Grantor in associated documents.
- b. Company’s Representative - The person or persons designated in the agreement to inspect the work performed on Company Property.
- c. Company’s Property - All property in which the company has an interest (easement or fee) including distribution easements, district office locations, and substations as they pertain to transmission use including towers, poles and wires, which also may be referred to as Grantor’s Property in associated documents
- d. Agreement – The written contract, letter agreement, or Document by which the company formally authorizes the use of its property by an outside party
- e. Grantee - The actual owner, developer, lessee, private person, partnership, company, corporation or governmental entity that is responsible for the maintenance and control of the facility or work authorized by the Agreement, which also may be referred to as Grantee in associated documents.
- f. Contractor – Any individual or business firm, separate from the grantee, but contracting to perform or supply part or all of the activity or facilities under the Grantee.

SPECIFICATION				
SHEET	3	of	35	SHEETS
SPEC ID	007	231	79	

- g. Subcontractor - Any individual or business firm, separate from the contractor, but contracting to perform or supply part or all of the activity or facilities under the Contractor. Any work performed by the Subcontractor and its agents or employees shall comply with the provisions of the Agreement as if they were employees of the Contractor.

3.0 GENERAL REQUIREMENTS FOR CONSTRUCTION

- a. The following General Requirements in this section are applicable to a Grantee/Contractor requesting permission to perform construction work on Company's Property. The Special Requirements in other sections apply in addition to these General Requirements.
- b. Any violation of the requirements contained herein shall be considered as grounds, by the Company's Representative, to stop the construction until corrective actions are taken.
- c. No work shall be performed on Saturdays, Sundays or holidays on Company's Property unless approved by the Company's Representative forty-eight (48) hours in advance.
- d. The Grantee/Contractor shall furnish to the Company's Representative access at all times to the work being done and to the premises used by the Grantee/Contractor, and shall provide every reasonable accommodation for the purpose of inspection, even to the extent of discontinuing portions of the work temporarily, or of uncovering or taking down portions of finished work.
- e. Upon project completion, the Grantee/Contractor shall return Company's Property to its original condition or better, including roads, fences, and gates.
  - The Grantee/Contractor shall grade Company's Property to a smooth finish, and all excess material shall be either removed from, or distributed on Company's Property as directed by the Company's Representative.
  - All swales, ditches, and other surface graded areas disturbed during construction shall be seeded with Bermuda grass in accordance with Texas Highway Department Item 164. Fertilizer application shall conform to Texas Highway Department Item 166 and shall have an analysis of 16-8-8.
  - All debris, vegetation or cleared materials shall be removed from Company's Property by the Grantee/Contractor, including:
    - ❖ Trash, rubble and any flammable materials.
    - ❖ Sand, concrete and construction materials.

SPECIFICATION			
SHEET	4	of	35 SHEETS
SPEC ID	007	231	79

- ❖ Containers of any type or character for the purpose of storing trash.
- ❖ Any material defined in environmental regulations as a solid waste, regulated toxic material or hazardous material.

f. DOCUMENTATION REQUIREMENTS

- The Grantee/Contractor shall have a copy of the signed Agreement at all times at the construction site where the operation of equipment is within Company's Property. It is the Grantee's responsibility to provide a copy of this specification to the Contractor and to ensure that all the provisions in the Agreement are followed.
- Any necessary field changes or modifications to the Agreement must be approved in writing by the Company's Representative prior to construction by the Grantee/Contractor.
- It is the Grantee/Contractor's responsibility to examine all the available records and to make a field inspection of the site and Company's Property for determination of the surface conditions and surface water conditions to be encountered, and the character of equipment and facilities needed for the desired work.

g. NOTIFICATION REQUIREMENTS

- The Grantee/Contractor shall be responsible for notifying all parties having an interest in or an easement on, under or above the subject Company's Property. The construction requirements of the parties with prior rights shall be observed; however, the Company's Specification for Construction shall be adhered to as a minimum.
- The Grantee/Contractor shall notify the Company's Representative seven (7) days prior to beginning any type of work so that an inspection of Company's facilities and/or properties can be arranged. The Grantee/Contractor shall provide the name and telephone number of their representative responsible for the construction activities to coordinate a preliminary inspection. The executing party of the Agreement shall pay the repair cost for damages to Company's facilities caused by the Grantee/Contractor.
- The Grantee/Contractor shall be responsible to call the One-Call Network at "8-1-1", forty- eight (48) hours prior to construction, to locate the Company's underground fiber optics line, and/or underground distribution facilities, and/or underground transmission facilities.

SPECIFICATION			
SHEET	5	of	35 SHEETS
SPEC ID	007	231	79

h. DAMAGE MITIGATION REQUIREMENTS

- Any use of land necessary by the Grantee/Contractor's operations which causes damage to property, crops, etc. shall be mitigated by the Grantee/Contractor at his expense.
- Any damage to Company's facilities or Company's Property caused by the Grantee/Contractor's operations shall be mitigated by the Grantee/Contractor at his expense.

i. SAFETY AND EQUIPMENT REQUIREMENTS

- It shall be the Grantee's responsibility to ensure that the Contractor be familiar with and comply with all local, state, and federal codes (i.e. Texas Health and Safety Code Chapter 752 and Federal Regulations, Title 29, CFR 1910.333, CFR 1926.1407-1411) for construction operations in close proximity to electrical power lines. The Grantee/Contractor shall comply with all applicable federal, state, and local environmental regulations concerning the loading and transportation of hazardous materials.
- The Grantee/Contractor shall take all precautions necessary, shall be responsible for the safety of the work, and shall maintain all lights, guards, barriers, barricades, signs, temporary passageways, or other protection necessary for that purpose. The work shall be carried on to completion without damage to any work or property of the Company or of others and without interference with the operation of existing machinery or equipment.
- The Grantee/Contractor shall be responsible at all times for the safety of the general public and for the protection of persons who may for any reason enter within the limits of his work and shall comply with all the laws of the State of Texas and the United States and with all valid rules and regulations now in force or hereafter adopted pursuant thereto. Effective barricades with acceptable warning and detour signs shall protect roads and highways closed to traffic. All barricades and obstructions shall be illuminated at night, and all lights shall be kept burning from sunset to sunrise. The Grantee/Contractor shall bear the entire expense and shall not be reimbursed directly or separately by the Company for providing and maintaining all necessary or required barricades, warning lights, danger signals, signs or other precautions for the protection of the work and safety of the public.

SPECIFICATION			
SHEET	6	of	35 SHEETS
SPEC ID	007	231	79

- If at any time the Grantee/Contractor's methods, materials or equipment appear to the Company's Representative to be unsafe, inefficient or inadequate for securing the safety of the workers, the public, or any Company's facilities, he may order the Grantee/Contractor to increase his safety, efficiency and adequacy, and the Grantee/Contractor shall comply with such orders. The failure of the Company's Representative to make such demands shall not relieve the Grantee/Contractor of his obligation to secure the quality and safe conduct of the work, and the grantee/Contractor alone shall be and remain liable and responsible for the safety, efficiency and adequacy of his methods, materials, working force and equipment, irrespective of whether or not any changes are made as a result of any orders received from the Company's Representative.
- The Grantee/Contractor shall immediately remove from the job, whenever requested to do so by the Company's Representative, any person considered to be disposed or disorderly, or for any other reason unsatisfactorily complying with the requirements of this specification, and such person shall not again be employed on the work without the consent of the Company.
- The Grantee/Contractor shall not permit or suffer the introduction or the use of intoxicating liquor or narcotic drugs upon any of the grounds occupied or controlled by the Company.
- No structure of any type shall be constructed on Company's Property unless a final set of detailed drawings have been reviewed and approved by the Transmission Operations Department. Structures include but are not limited to signs, fences, paving, lighting, drainage facilities, etc. All structures of any type must be properly grounded.
- No temporary fuel tanks shall be stored on Company's Property unless prior written approval has been granted. Prior to approval, a specific location will be determined by the Company's Representative and the Grantee/Contractor. Fuel tanks within Company's Property must be adequately grounded and bermed for spill protection.
- No equipment or material shall be permitted on Company's Property at a height greater than 15 feet above natural ground elevation, unless approved by the Company's Representative. Cranes, lifts, etc. shall be blocked so that operators may not bring the boom to a greater height.
- Trenching and excavation will not be permitted within twenty (20) feet of any structure foundation or other facilities measured at ground level unless approved by the Company's Representative.

S P E C I F I C A T I O N			
SHEET	7	of	35 SHEETS
SPEC ID	007	231	79

- Excavation shall comply with CFR 1926.651. The installation of sheet piling, cribbing or other protective measures beyond the scope of CFR 1926 .651 will be required if stipulated by the Company's Representative.
- No self-propelled equipment shall be allowed directly beneath a lattice tower.

j. RIGHT OF WAY ACCESS REQUIREMENTS

- The Grantee/Contractor shall not sell, assign, or remove equipment or materials which have been installed by or which are owned by the Company and may be necessary for right-of-way access or any other activities without the written consent of the Company's Representative.
- No equipment, material, or railroad cars shall be stored on Company's Property without prior written consent.
- A minimum 20-foot wide access path along Company's Property shall be kept free of obstacles at all times to provide a passable area for the Company's equipment to travel.
- The Grantee/Contractor upon the request of the Company's Representative shall use matting on the right-of-way for temporary access on or across Company's Property.

k. DRAINAGE REQUIREMENTS

- Under no circumstances shall the natural drainage pattern of Company's Property be blocked or altered by construction. All previously existing ditches shall be re-established.
- All reinforced concrete pipes installed on Company's Property should be Class IV as specified by ASTM Specification C76 and should have a minimum of 12 inches of cover.
- All corrugated steel pipe and high density polyethylene pipe used for culverts and installed on Company's Property should be 16 gauges with 2 & 2/3" x 1/2" or 3" x 1" corrugations and have a minimum of 12 inches of cover or manufacturer's specified cover.
- The top of all manholes shall be built at final grade and must be capable of HS-20-44 loading, (A ASHTO 17th Edition-2002). All manholes must be protected with a minimum of four 6" diameter bollards made of wood or steel that are 6' long and set at least 24" in the ground with 48" above the ground.

S P E C I F I C A T I O N			
SHEET	8	of	35 SHEETS
SPEC ID	007	231	79

I. SPOILING REQUIREMENTS

- No spoiling is allowed unless written approval has been obtained.
- Spoiling, if allowed, shall be done as directed by the Company's Representative. The spoil material shall be free of concrete, asphalt, steel, wood, or any other objectionable material. Spoil material shall not be stockpiled or placed over any distribution manholes, pull holes, etc. The spoil material shall be spread in lifts not to exceed 12" and compacted as required by the Company's Representative. The end results of spoiling and grading shall yield positive drainage and flow with no ponding.
- The elevation beneath any of the Company's structures within the limits of the proposed work shall be maintained equal to or greater than the surrounding finished grade elevation. Spoil material, if approved in writing, shall not exceed a point six (6) inches below the top elevation of the concrete cap of a tower foundation. Any spoil material added beneath the tower shall be compacted to 95% density with a tamper or hand vibratory equipment and shaped to a smooth finish to provide proper drainage.

4.0 SPECIAL REQUIREMENTS FOR PIPELINES AND VALVE SITES, COMMUNICATION CABLES AND CABLE TELEVISION INSTALLATIONS

- a. Pipelines shall have a minimum cover of four (4) feet, measured from the top of the pipe to the natural ground level, unless otherwise specified in the Agreement.
- b. Pipelines to be installed within twenty (20) feet of any structure foundation shall be installed by either boring, tunneling, or other protective methods approved by the Company Representative. Where boring is performed, the hole shall not be more than one (1) inch greater than the outside diameter of the pipe and the protective coating or casing. Where tunneling is performed and column bents of concrete are used, the top of the concrete shall be a minimum of three (3) feet below ground level and the remainder of the column shall be filled and compacted at lifts not to exceed twelve (12) inches to 95% Standard Proctor density. De-watering will not be permitted unless approved by the Company's Representative.
- c. Trenches shall be backfilled, sufficiently compacted to prevent future settlement, and crowned as required by the Company's Representative. For any settlement that occurs as a result of access for the associated pipeline installation, the owner of the pipeline, upon request, shall fill or smooth the Company's right-of-way as directed.

SPECIFICATION			
SHEET	9	of	35 SHEETS
SPEC ID	007	231	79

- d. No structure of any type shall be constructed on Company's Property unless described in detail in the formal agreement document, except for test point terminals and pipeline markers, which shall be installed in locations such that they do not create an obstruction to Company's equipment traveling within Company's Property.
- e. If at any time the pipe is abandoned, the pipe shall be removed by the pipeline owner. If the pipe cannot be removed because of possible damage to Company's facilities (tower foundation, poles, etc.), the pipeline shall be cut 20' away from each side of the Company facility and the abandoned pipe section filled with grout to prevent future caving or settling.
- f. Pipelines with a proposed location between a Company's structure and a down guy anchor or other appurtenance will be bored or tunneled unless specific approval has been granted by the Company's Representative.
- g. New or relocated pipeline occupations that are located between a lattice tower's foundations will require the Company to install "Mower Guards" (Company Drawing #006-203-07) at each tower at the expense of the requesting pipeline company.
- h. The following are additional requirements applicable to installations of valve and metering sites within Company's Property.
  - No valve site or station is to be located closer than fifty (50) feet to a transmission structure or appurtenance without exclusive written consent.
  - Valve sites or stations are to be located on Company's Property such that they do not limit access along Company's Property.
  - Valve sites or stations are to have perimeter barricades or fences installed in order to prevent damage from equipment traveling along Company's Property.
  - Valve sites or stations, plus an additional three (3) feet outside the site area, shall be kept free of high grass and weeds at all times by the valve owners.
  - Valve sites or stations are to be well marked with the owner's name and telephone number to be called in cases of emergency.
  - No blow-off vents or flares are to be located on Company's Property.
  - Grounding/Anode Beds will be treated as a Valve Site, separately from the pipelines.

S P E C I F I C A T I O N			
SHEET	10	of	35 SHEETS
SPEC ID	007	231	79

i. The following are additional requirements for pipeline crossings of the Company's underground electric distribution facilities.

- The Company will furnish upon Grantee/Contractor's request any drawings of the existing underground distribution facilities.
- If a crossing is required, the pipeline shall be installed beneath the Company's underground distribution facilities. A minimum vertical clearance of eighteen (18) inches must be maintained between the Company's underground distribution facilities and any other facilities (i.e. outside pipe wall to outside concrete encasement or pipe wall).
- If a pipeline is installed parallel to the Company's underground electric distribution facilities, a minimum horizontal clearance of five (5) feet must be maintained between the Company's underground distribution facilities and any other facilities (i.e. outside pipe wall to outside concrete encasement or pipe wall).
- If the Company's concrete encased duct bank is to be exposed during the installation or maintenance of a pipeline, the Company's duct bank must be fully supported every four (4) feet.
- Upon completion of the work, Grantee shall furnish the Company with a complete set of as-built drawings. Any substitutions or changes made by the Contractor/Grantee for the purpose of fabrication or installation shall be marked by Contractor/Grantee on those drawings and accompanied by a complete revised metes and bounds or centerline description if applicable.

j. COMMUNICATION CABLES AND CABLE TELEVISION INSTALLATIONS

- Overhead cables must be approved by a Representative from the Asset Planning and Optimization Transmission Encroachment & 3rd Party Use Department, for location and maximum and minimum height requirements.
- All underground occupations must be buried with a minimum 4.0' of cover and all above ground appurtenances must be approved for location.

SPECIFICATION				
SHEET	11	of	35	SHEETS
SPEC ID	007	231	79	

5.0 SPECIAL REQUIREMENTS FOR DRAINAGE DITCHES

- a. Ditch side slopes along Company's Property shall be "Asphalt Mulch Seeded" with Bermuda grass in accordance with Texas Highway Department, Item 164. Application of seed shall be at the rate of forty (40) pounds per acre. Asphalt Film Spray Emulsion SS-1, CSS-1, CMS-25, or MS-2 shall be used. This spray is to be applied at the rate of 0.2 to 0.4 gallons per square yard. Fertilizer application shall conform to Texas Highway Department, Item 166 and shall have an analysis of 16-8-8 urea form.

ALTERNATE: The Grantee/Contractor may use solid "Block Sodding" on ditch side slopes in accordance with Texas Highway Department, Item 162.

- b. Cement stabilized limestone and cement stabilized sand shall conform to Company's Specification #007-229-06, attached hereto and made a part hereof.
- c. Unless specified otherwise, the Grantee/Contractor shall install, for the exclusive use of the Company, a culvert crossing for access to Company's Property with a roadway width of twenty four (24) feet. The Grantee/Contractor shall install the roadway at the location stipulated in the Agreement or as determined by the Company's Representative.
- d. Ditch design shall be such that erosion and slope stability is controlled by flat side slopes, natural vegetation, riprap or other approved methods. The side slopes of ditches shall not be steeper than 4:1.
- e. The high bank of any ditch shall not be closer than twenty four (24) feet to any structure foundation measured at ground level unless approved by the Company's Representative. The high bank of any ditch shall not be closer than three (3) feet to any wood poles or appurtenances measured at ground level unless approved by the Company's Representative. If this is not possible, the wood poles will be braced or relocated by the Company at the Grantee/Contractor's expense.

6.0 SPECIAL REQUIREMENTS FOR STREETS, ROADS, HIKE AND BIKE TRAILS, AND PLAY GROUND EQUIPMENT

- a. Barricades to protect the Company's structures shall be installed as required before construction of the street or road begins.
- b. Unless specified otherwise, the Grantee/Contractor shall install, for the exclusive use by the Company, a twenty four (24) foot wide drive on both sides of the street or road. The Grantee/Contractor shall install the drive at the location stipulated in the Agreement or as determined by the Company's Representative. Curb cut-outs shall be installed with a five (5) foot radius.

SPECIFICATION				
SHEET	12	of	35	SHEETS
SPEC ID	007	231	79	

- c. Adequate drainage for Company's Property shall be provided and indicated on plan and profile drawings at each street or road crossing. Installation of drainage structures and/or shaping of the adjacent property to ensure proper drainage of Company's Property shall be done at Grantee/Contractor's expense.
- d. Hike and Bike Trail minimum standards are referenced on CenterPoint Energy Transmission Standard, Hike and Bike Trails, Minimum Standards Drawings. Subject to full review and subject to change based on the field notes.
- e. PLAY GROUP EQUIPMENT or ANY RECREATION FACILITIES is prohibited within Company's Property without any exception.

7.0 SPECIAL REQUIREMENTS FOR SPUR TRACKS

- a. Company's structures located within twelve (12) feet of the nearest rail of the proposed rail spur shall be relocated at the spur track owner's expense. The Company's construction forces will relocate the structures.
- b. For the exclusive use of the Company, the Grantee/Contractor shall install a twenty four (24) foot wide grade crossing over the spur track in accordance with local railroad specifications. Before construction can begin, the Grantee/Contractor shall assume responsibility for the exact location of the grade crossing with respect to the Company's right-of-way line as determined by the Company's Representative. If the spur right-of-way is to be cross-fenced, a twenty four (24) foot wide gate shall be installed in each cross fence at/and parallel to the grade crossing.
- c. The top rail elevation shall not exceed four (4) feet above the natural ground elevation of the Company's right-of-way.

8.0 SPECIAL REQUIREMENTS FOR PARKING FACILITIES

- a. Parking lot plans showing the area to be surfaced, curbs, fences, drainage and traffic access routes as applicable must be submitted to and approved by the Company's Representative prior to the granting of the Agreement.
- b. No through roads will be allowed along Company's Property; therefore, if the parking lot has multiple entrances, the lot must be so constructed that through traffic is not possible.
- c. Company's Property requested for parking must be immediately adjacent or substantially close to the Grantee's property.

SPECIFICATION			
SHEET	13	of	35 SHEETS
SPEC ID	007	231	79

- d. The Grantee/Contractor shall be responsible for any damage to Company's facilities. This includes all existing structures as well as future structures. Barriers will be required if the proposed parking facility or any drives associated with the parking area are closer than ten (10) feet to any transmission facility. Barriers in accordance with Company's Drawing #006-203-01, 006-203-02, or 006-203-04, attached hereto and made a part hereof, shall be installed.
- e. If fences or traffic restrictors are placed across Company's Property, the Grantee/Contractor must install a twenty four (24) foot gate in accordance with Company's Drawing #GC3GATE, attached hereto and made a part hereof, on which the Company will install a chain and lock.
- f. The Company reserves the right to enter and traverse any parking facility as required for inspection, maintenance or construction purposes and reserves the right to cancel all or part of the agreement as may be required for the installation of future facilities or maintenance of existing facilities.

9.0 SPECIAL REQUIREMENTS FOR NURSERY OPERATIONS

- a. Liquid fertilizer is not allowed on Company's Property.
- b. No permanent sprinkler systems are allowed on Company's Property.
- c. Only containerized trees and plants will be allowed on nursery operations and only to a maximum height of ten (10) feet.
- d. No berms or earthen mounds will be allowed.
- e. The Company is not to be held responsible for any plants that may be damaged due to emergency repair of the Company's facilities.

10.0 SPECIAL REQUIREMENTS FOR DECORATIVE PLANTING

- a. No plants which at maturity are taller than ten (10) feet will be approved and subject to approval on a case by case basis. No planting shall be made closer than twenty (20) feet to any Company's structure.
- b. No trees of any type will be allowed.
- c. No berms or earthen mounds will be allowed.
- d. No permanent sprinkler systems are allowed on Company's Property.
- e. Liquid fertilizer is not allowed on Company's Property.

SPECIFICATION				
SHEET	14	of	35	SHEETS
SPEC ID	007		231	79

- f. The Company reserves the right to have plantings removed by the Grantee/Contractor without notice. Should plantings not be removed, the Company will remove the plantings and not be liable for their replacement.
- g. Any vegetation placed within Company's Property without prior written approval may be removed by the Company. The Grantee/Contractor shall be responsible for reimbursing the Company for removal of unauthorized plantings.
- h. The Company is not to be held responsible for any decorative grass or plants that may be damaged.
- i. Grantee shall keep Company Property free of high grass, weeds, and trash within the area covered by the Agreement.

11.0 SPECIAL REQUIREMENTS FOR PROTECTING CULTURAL RESOURCES, ARCHAEOLOGICAL SITES, AND THREATENED AND ENDANGERED PLANTS AND ANIMALS

a. Archaeological and historical sites

- Known or potential archaeological or historical site(s)
  - ❖ The Grantee/Contractor shall conspicuously mark the site areas in the field to ensure the areas are avoided by construction activities.
  - ❖ If a site is determined to be located in a wooded area, any necessary vegetation clearing shall be done in such a manner that the root zone is not disturbed until an archaeologist has completed and investigation of the site, including removal of all artifacts. This may be accomplished by using manually operated chain saws or mechanical cutters to cut down trees at ground level and lifting them onto trucks for transport out of the right of way rather than dragging them. When archaeological work is completed, stump grinders may be used to remove the remaining portions of large trees below ground level, after which the surrounding surface can be prepared for construction. More specific procedures for avoidance or lessening of damage to sites will be decided on a site-by-site basis, or as directed by the State Historic Preservation Office.
  - ❖ In certain circumstances, it may be necessary for vehicles to cross the identified archaeological/ historical areas. In such cases, loose earth fill, or other temporary ground cover, in a thickness necessary to prevent damage by the passage of vehicles over the site surface will be placed on such sites. The fill shall be a contrasting color or texture so as to allow re-establishment of the original site surface at a later date. The Grantee/Contractor shall document the placement and removal of such temporary fill.

SPECIFICATION			
SHEET	15	of	35 SHEETS
SPEC ID	007	231	79

- Unknown archaeological or historical site(s)
  - ❖ Upon discovery of any evidence of an archaeological or historical site (e.g. accumulations of oyster shells or other seashells, pottery or pottery pieces, animal or human bones, rusted metal such as nails or cannon balls), all construction operations in the immediate vicinity shall cease. The Grantee/ Contractor shall promptly contact the Company's Representative.
  - ❖ The Company will contact qualified environmental contractors to investigate the discovered site in accordance with applicable procedures and guidelines. The area of significance will be conspicuously marked in the field so that construction activities may proceed while avoiding the site.
- Mitigation process
  - ❖ If a structure or site cannot be protected through any relocation, stabilization or restoration technique, then mitigation of the construction effects on archaeological and/or historical sites will be performed in accordance with applicable procedures and guidelines as directed by the State Historic Preservation Office.

b. Endangered or threatened plants and animals

- Known locations of species and/or their habitats
  - ❖ The company may provide the Grantee/Contractor any previously documented sites of any known endangered and threatened species that it has discovered along the construction route. Where such documentation is provided, the Grantee/Contractor shall implement any mitigating actions required by the Company.
- Unknown locations of species and/or their habitats
  - ❖ If during construction, the Grantee/Contractor discovers an endangered or threatened plant or animal species, the Grantee/Contractor shall cease all work in that immediate area. The Grantee/Contractor shall promptly notify the Company's Representative who will notify the appropriate State/Federal agencies for any required mitigating actions.

SPECIFICATION				
SHEET	16	of	35	SHEETS
SPEC ID	007	231	79	

- ❖ If during construction, the Grantee/Contractor discovers an endangered or threatened plant or animal species, the Grantee/Contractor shall cease all work in that immediate area. The Grantee/Contractor shall promptly notify the Company's Representative who will notify the appropriate State/Federal agencies for any required mitigating actions.
- Mitigation process
  - ❖ Any mitigation concerning endangered and/or threatened species, applicable to the project construction, will be reviewed by the Company and communicated to the Grantee/Contractor. Only when necessary mitigation measures have been completed by the Grantee/Contractor will construction work be reinitiated

SPECIFICATION			
SHEET	17	of	35 SHEETS
SPEC ID	007	231	79



RECORDER'S MEMORANDUM  
 This page is not satisfactory for photographic recordation due to carbon or photo copy, discolored paper, etc. All block-outs, additions and changes were presented at time instrument was filed and recorded.

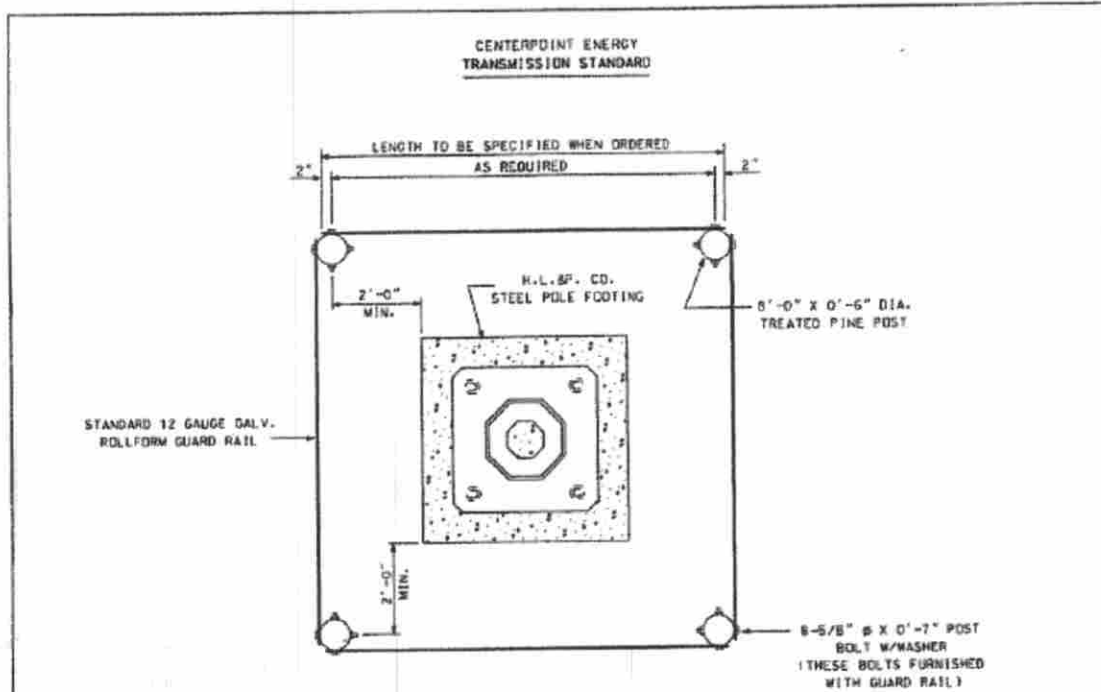

**PLAN**

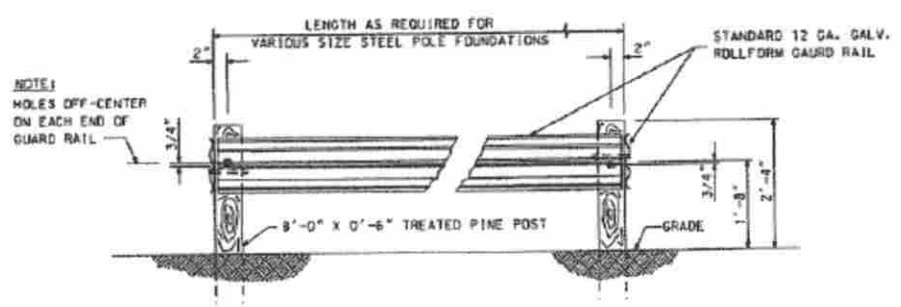

**ELEVATION**

NOTE:  
HOLES OFF-CENTER  
ON EACH END OF  
GUARD RAIL

FOR USE ON HOUSTON LIGHTING AND POWER CO.  
RIGHTS-OF-WAY.

BARRIERS	
<b>TYPICAL DETAILS GALVANIZED ROLLFORM STEEL POLE GUARD RAIL</b>	
SCALE: <b>NTS</b>	SHEET <b>1</b> OF <b>1</b> <b>006-203-02</b>

NO.	DATE	REVISION	BY	CHK	APP	APPR	DRWG D-100-70	CHECK D-100-70	DATE D-100-70	BY E.A. TURNER	APP D.E. SIMMONS
1	11-19-93	CONVERT TO CAD	AKW								

SPECIFICATION			
SHEET	19	of	35 SHEETS
SPECID	007	231	79

RECORDER'S MEMORANDUM

This page is not satisfactory for photographic recordation due to carbon or photocopy, discolored paper, etc. All block-outs, additions and changes were presented at time instrument was filed and recorded.

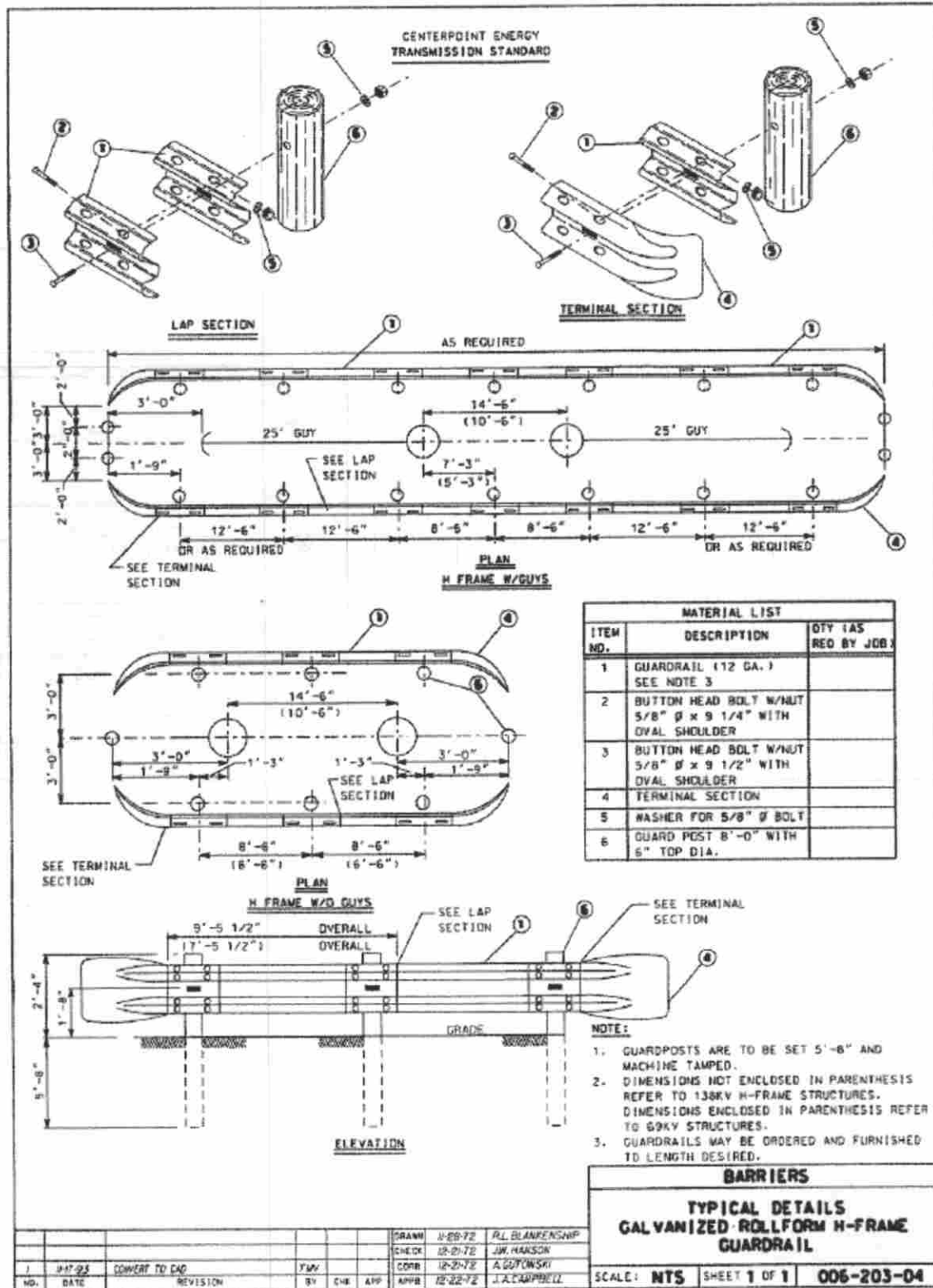

SPECIFICATION			
SHEET 20 of 35 SHEETS			
SPEC ID	007	231	79

RECORDER'S MEMORANDUM

This page is not satisfactory for photographic recotation due to carbon or photocopy, discolored paper, etc. All block-outs, additions and changes were presented at time instrument was filed and recorded.

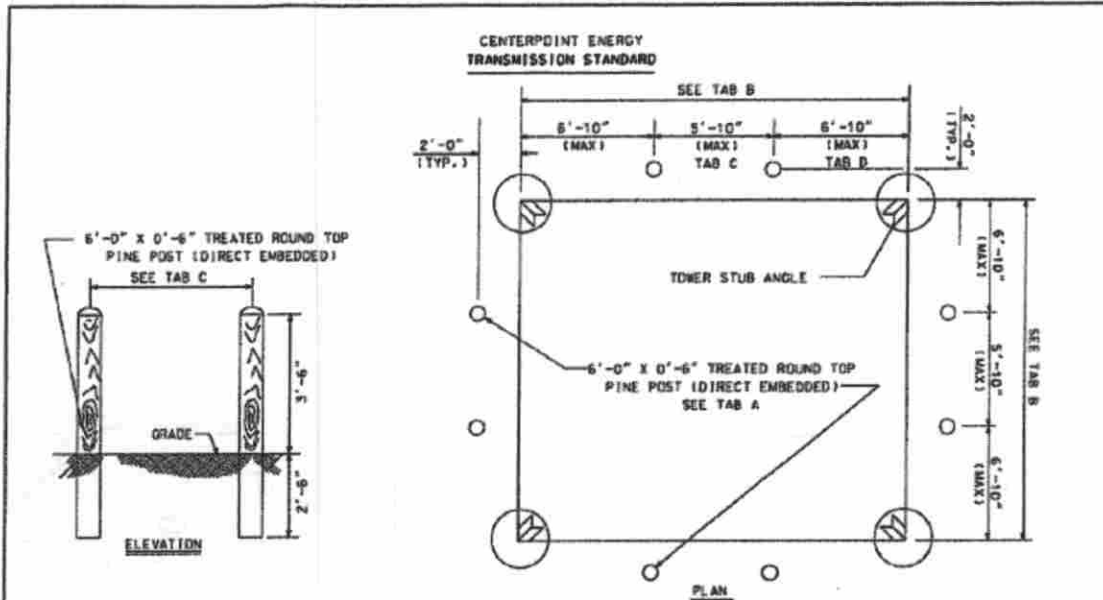

DIMENSIONAL SPACING OF WOOD BARRIERS FOR SQUARE BASE TOWERS			
A	B	C	D
NO. OF BARRIERS PER SIDE	DIMENSION BETWEEN TOWER LEGS	DIMENSION BETWEEN BARRIERS	DIMENSION BETWEEN BARRIERS AND TOWER LEG
2 BARRIERS	14'-9" TO 17'-5"	4'-11" TO 5'-10"	EVENLY SPACED
	17'-6" TO 19'-6"	5'-10" (MAX)	5'-10 1/2" TO 6'-10" (MAX)
3 BARRIERS	19'-7" TO 23'-4"	4'-11" TO 5'-10"	EVENLY SPACED
	23'-5" TO 25'-4"	5'-10" (MAX)	5'-10 1/2" TO 6'-10" (MAX)
4 BARRIERS	25'-5" TO 29'-2"	5'-1" TO 5'-10"	EVENLY SPACED
	29'-3" TO 31'-2"	5'-10" (MAX)	5'-10 1/2" TO 6'-10" (MAX)
5 BARRIERS	31'-3" TO 35'-0"	5'-2" TO 5'-10"	EVENLY SPACED
	35'-1" TO 37'-0"	5'-10" (MAX)	5'-10 1/2" TO 6'-10" (MAX)
6 BARRIERS	37'-1" TO 40'-10"	5'-3 1/2" TO 5'-10"	EVENLY SPACED
	40'-11" TO 42'-10"	5'-10" (MAX)	5'-10 1/2" TO 6'-10" (MAX)
7 BARRIERS	42'-11" TO 46'-8"	5'-4 1/2" TO 5'-10"	EVENLY SPACED
	46'-9" TO 48'-8"	5'-10" (MAX)	5'-10 1/2" TO 6'-10" (MAX)

INSTRUCTIONS:

1. MEASURE DISTANCE BETWEEN TOWER LEGS AT STUB ANGLES.
2. LOCATE DIMENSION IN TAB "B".
3. DETERMINE BARRIER SPACING FROM TAB "C" AND "D". BARRIERS MAY BE SPACED EVENLY OR UP TO A MAXIMUM OF 5'-10" BETWEEN BARRIERS AND A MAXIMUM OF 6'-10" BETWEEN THE END BARRIER AND TOWER LEG.
4. BARRIERS TO BE LOCATED 2'-0" OUTSIDE THE PERIMETER OF THE BASE, MEASURED FROM THE STUB ANGLE (SEE PLAN VIEW).
5. POST TO BE SET 2'-6" DEEP
6. THE CONTRACTOR IS RESPONSIBLE FOR LOCATING ALL UNDERGROUND UTILITES BEFORE DIGGING.

LOCAL POST SUPPLIERS: SAN BASSETT LUMBER  
 ADDRESS: 3839 POLK STREET  
 PHONE: 713-223-9154

BARRIERS	
WOOD POST MOWER BARRIER INSTALLATION FOR TOWERS	
SCALE: NTS	SHEET 2 OF 2 006-203-07

NO.	DATE	REVISION	BY	CHK	APP	APPR	DATE	DRWN	10-20-06	KL WHITE
1	04-23-07	REVISED POST SUPPLIER	RAB	RJW	KLW	CDM	10-20-06	CHKD	10-20-06	RJ BUTTRICK
							10-20-06			MD KOROSZ
							10-20-06			MJ FAKELTIS

SPECIFICATION			
SHEET 21 of 35 SHEETS			
SPEC ID	007	231	79

GC3GATE..

CENTERPOINT ENERGY  
TRANSMISSION STANDARD

I T E M	DESCRIPTION	M/N	U N I T	QUANTITY			
				GAP GATE		TUBE GATE	
				NEW	MAINT	NEW	MAINT
	FCA 352			G	G	G	G
				S	S	S	S
				A	A	A	A
				T	T	T	T
				E	E	E	E
				F	F	S	H
1	POST, 10' TREATED PINE W/7"-10" TOPS	100299	EA	-	-	4	-
2	POST, 8' TREATED PINE W/5"-6" TOPS	100100	EA	4	4	-	-
3	POST, 7' TREATED PINE W/3" TOPS	100089	EA	4	4	2	-
4	WIRE, BARBED 12 1/2 GAUGE (1320')	111278	SP	-	15	-	-
5	WIRE, BARBLESS STEEL 2 PLY GALV. (1320')	111207	SP	25	10	10	-
6	STAPLES, 1 1/2" GALVANIZED	137263	LB	1	1	1	-
7	MAILS, WIRE 100 GALVANIZED	137350	LB	1	1	1	-
8	RIVET, FLAT HEAD, 3/8" DIA., 1/4"	110795	EA	-	-	4	2
9	WASHER, CURVED, 4"x4"x1/4", 11/16" HOLE	225701	EA	-	-	8	4
10	GATE, G-RAIL, TUBE, GALVANIZED 12"x50"	245425	EA	-	-	2	1
11	STAY, TWISTED 42", GALVANIZED	111283	EA	3	3	-	-
12	PADLOCK, HS DOUBLE BALL STAINLESS STEEL, 2" OPENING	225147	EA	1	1	1	1
13	CHAIN, COIL 1/4"	136483	FT	5	5	2	2



GC3.....  
STRUCTURE CLASSIFICATION  
STRUCTURE TYPE

A/U KEY  
STRUCTURE CLASSIFICATION

GATE - GATE  
STRUCTURE TYPE

- F - GAP GATE (BARBLESS WIRE)
- G - GAP GATE (BARBED WIRE)
- S - TUBE GATE, G-RAIL
- H - TUBE GATE & HARDWARE REPLACEMENT ONLY

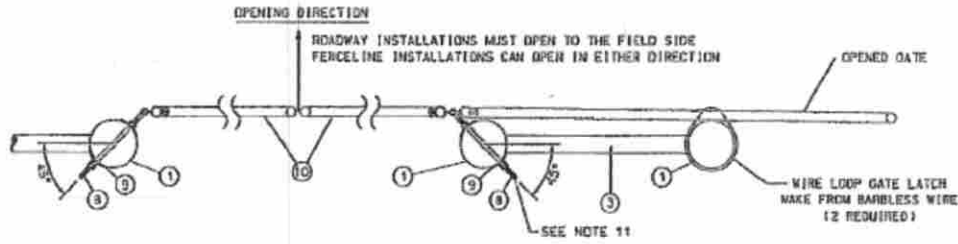

DETAIL "A"  
POST AND GATE ATTACHMENT DETAIL

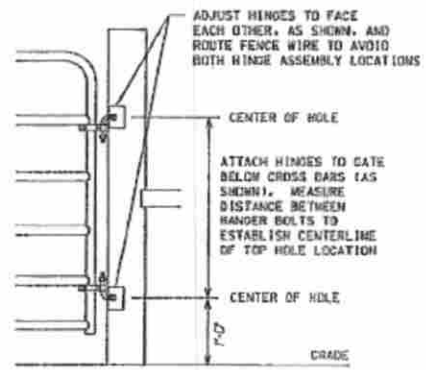

DETAIL "B"  
GATE POST HINGE ATTACHMENT DETAIL

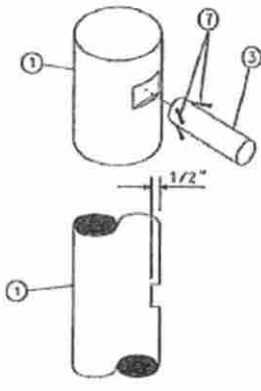

DETAIL "C"  
HORIZONTAL WOOD BRACE DETAIL

GATES & CULVERTS

Sheet 23 of 36

NO.	DATE	REVISION	BY	CHK	APP	DRAWN	CHECK	DATE	BY
3	02-07-06	REDESIGNED FOR NEW INSTALLATION	RJS	RJS	MJP			02-03-06	RLBUTTRICK
2	08-01-00	REPLACED FENCE GATE W/ PIPE GATE	RJS	RJS	MJP			02-03-00	RLBUTTRICK
1	01-09-99	ADDED BOX TO DRAWING 7. BLOCK	RJS	RJS	MJP			02-03-99	RLBUTTRICK
								02-04-99	NALPANTZIS

SCALE: NTS SHEET 1 OF 2 GC3GATE

RECORDER'S MEMORANDUM  
 This page is not satisfactory for photographic recordation due to carbon or photocopy, discolored paper, etc. All block-outs, additions and changes were presented at time instrument was filed and recorded.

SPECIFICATION			
SHEET	22 of 35 SHEETS		
SPEC ID	007	231	79

RECORDER'S MEMORANDUM  
 This page is not satisfactory for photographic recordation due to carbon or photocopy, discolored paper, etc. All block-outs, additions and changes were presented at time instrument was filed and recorded.

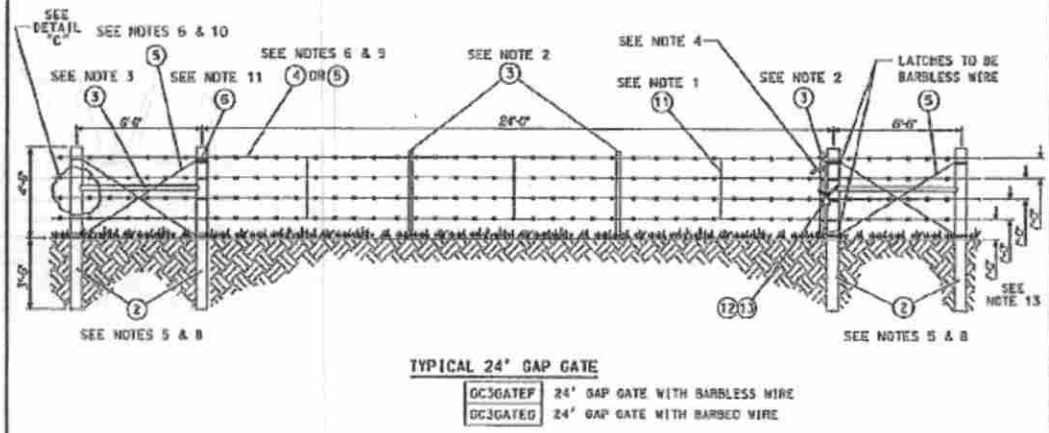
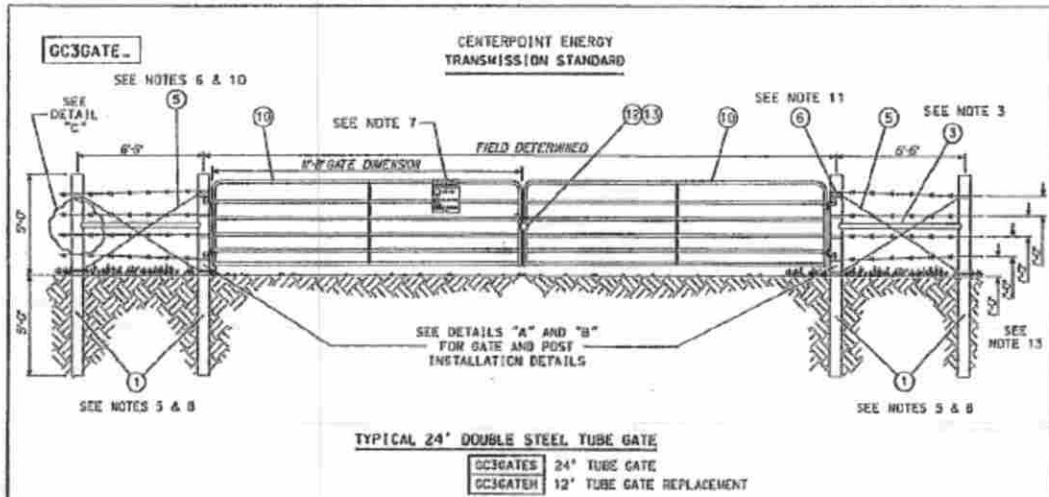

**NOTES:**

1. 2" DIAMETER WOOD POST MAY BE SUBSTITUTED FOR STAYS. (INR-STOCK ITEM).
2. VERTICAL BRACE POSTS AND LATCH POST (3) TO BE FABRICATED OUT OF POST FROM M/N 100089, CUT TO 4'-6".
3. HORIZONTAL BRACE POST (3) TO BE FABRICATED OUT OF POST FROM M/N 100089, CUT TO 6'-6".
4. WOOD CHEATER TO BE FABRICATED FROM WOOD POST SCRAP.
5. ALL TIMBER AND POSTS SHALL BE TREATED IN ACCORDANCE WITH AMPA SPEC. C-1, C-5, P-1 LATEST REVISION. FINAL NET RETENTION OF CREOSOTE TREATED BY ASSAY = 8 PCF.
6. ALL WIRE SHALL BE 12 1/2 GAUGE AND MUST MEET ASTM SPEC. A-121.
7. NOTICE SIGNS TO BE INSTALLED AT ALL ROADWAY INSTALLATIONS ON PROPERTY OWNED BY CENTERPOINT ENERGY. TO INSTALL NOTICE SIGN USE ASSEMBLY UNIT [SONIAGM].
8. POSTS ARE TO BE TAMPED WITH NATIVE BACKFILL.
9. BARBLESS WIRE TO BE USED WITHIN INCORPORATED CITY LIMITS.
10. BRACE WIRES ARE TO BE WRAPPED TWICE AROUND POSTS, PULLED, AND STAPLED.
11. WHEN DEADENDING WIRE, PULL UNDER FULL TENSION, WRAP TWICE AROUND POST, THEN TWICE AROUND WIRE, AND STAPLE SEVERAL PLACES ON POST.
12. ALL NUTS ON GATE BOLTS SHALL BE WELDED OR GATE BOLTS STRIPPED TO PREVENT REMOVAL.
13. WIRE SPACING MAY VARY IN ORDER TO BE COMPATIBLE WITH EXISTING FENCE.

<b>GATES &amp; CULVERTS</b>		
Sheet 24 of 36		
SCALE: NTS	SHEET 2 OF 2	GC3GATE

NO.	DATE	REVISION	BY	CHK	APP	APPR
3	02-27-91	REDRAW FOR NEW 24' DESIGN	ALB	ALB	MJP	DRM
2	04-09-91	REPLACED FENCE GATE W/ PIPE GATE	FYS	ALB	MJP	CHEK
1	04-09-91	ADDED ROW TO DWG/REV FENCE	ALB	ALB	MJP	CEM
						02-04-93

<b>SPECIFICATION</b>			
SHEET 23 of 35 SHEETS			
SPEC ID	007	231	79

RECORDER'S MEMORANDUM

This page is not satisfactory for photographic recordation due to carbon or photocopy, discolored paper, etc. All block-outs, additions and changes were presented at time instrument was filed and recorded.

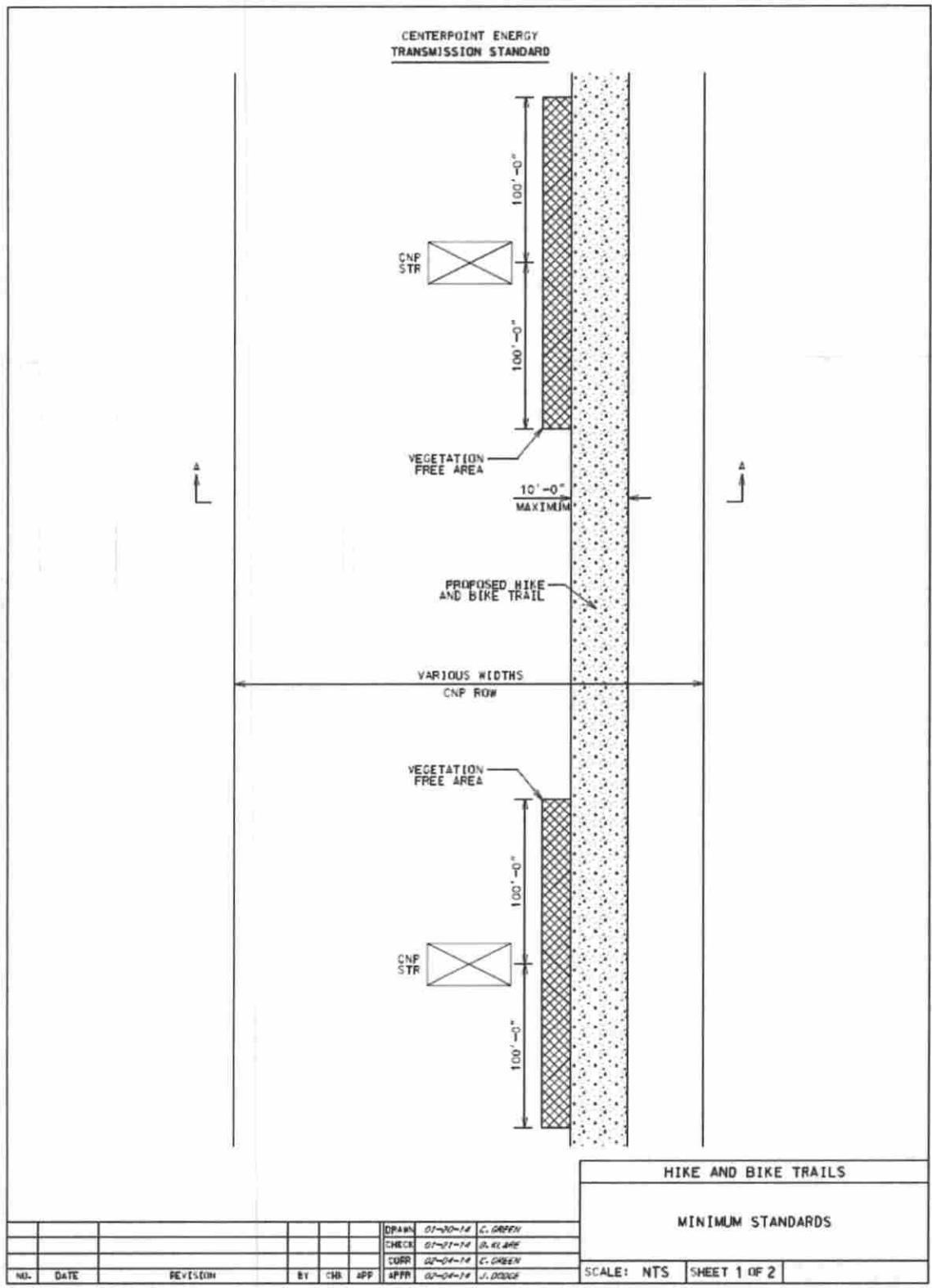

<b>SPECIFICATION</b>			
SHEET 24 of 35 SHEETS			
SPEC ID	007	231	79

**CENTERPOINT ENERGY  
TRANSMISSION STANDARD**

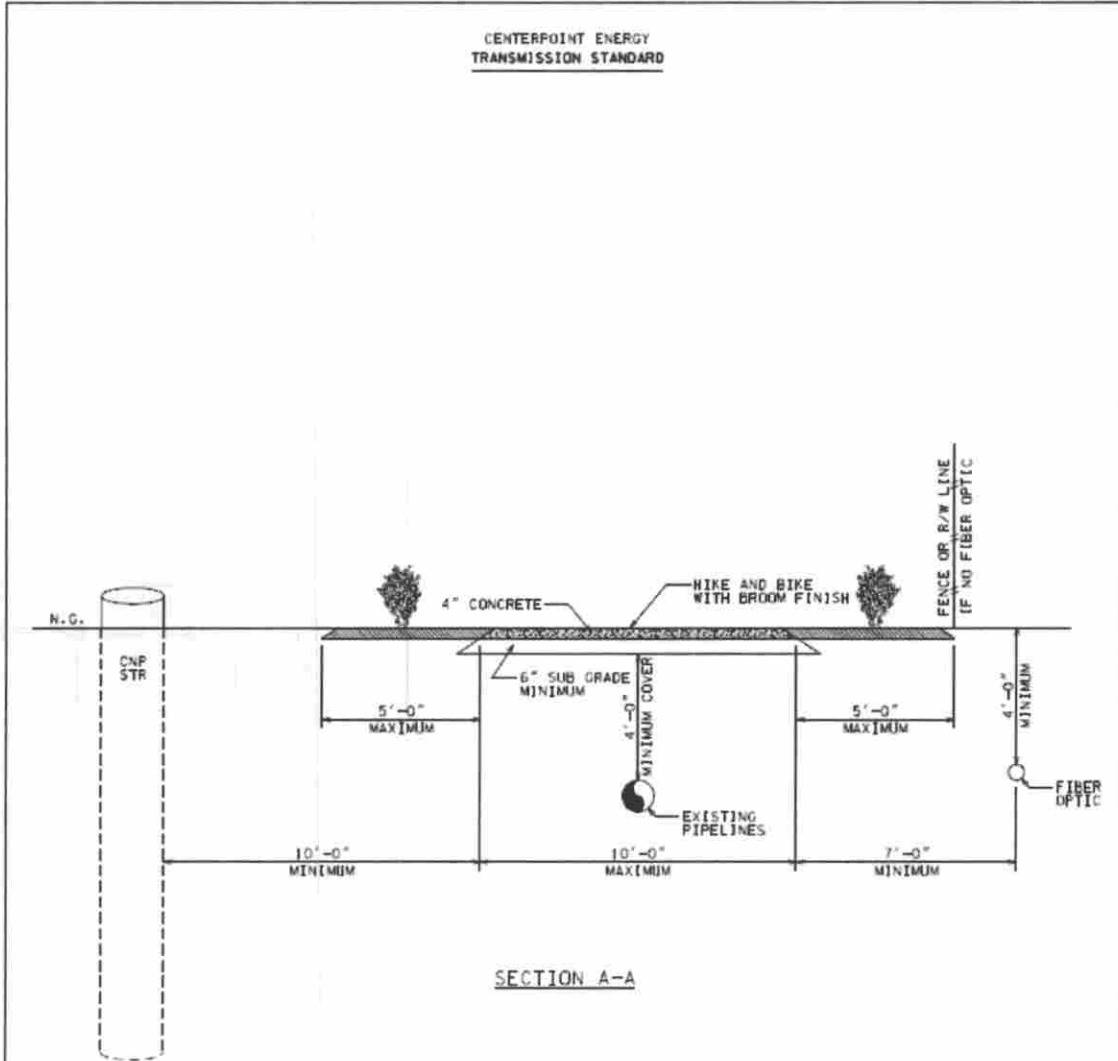

**SECTION A-A**

**RECORDER'S MEMORANDUM**

This page is not satisfactory for photographic recordation due to carbon or photocopy, discolored paper, etc. All block-outs, additions and changes were presented at time instrument was filed and recorded.

										<b>HIKE AND BIKE TRAILS</b>		
										<b>MINIMUM STANDARDS</b>		
										SCALE: NTS	SHEET 2 OF 2	
<b>NO.</b>	<b>DATE</b>	<b>REVISION</b>	<b>BY</b>	<b>CHK</b>	<b>APP</b>	<b>APPR</b>	<b>DRAWN</b> 01-20-14 C. GREEN	<b>CHECK</b> 01-21-14 D. FLARE	<b>CURR</b> 02-04-14 C. GREEN	<b>APPR</b> 02-04-14 J. GUNGE		

<b>SPECIFICATION</b>			
SHEET 25 of 35 SHEETS			
SPEC ID	007	231	79

12.1 SCOPE

- a. This specification covers the furnishing of labor, material, equipment, permits and supervision necessary for the installation of flexible base road and yard paving on CenterPoint Energy’s property.

12.2 GENERAL

- a. The paving work shall be done in accordance with the CenterPoint Energy’s Purchase Order, CenterPoint Energy’s drawings, CenterPoint Energy’s Job Specifications, General Conditions for Construction (CenterPoint Energy’s Specification 007-231-79), this specification, the Texas Highway Department Standards (THD), American Society for Testing Materials Standards (ASTM), and the American Wood Preservers Association Standards (AWPA).
- b. In case of conflict, the order of precedence shall be the CenterPoint Energy’s Purchase Order, CenterPoint Energy’s Job Specification, CenterPoint Energy’s drawings, this Specification, the General Conditions for Construction, and the THD, ASTM and AWPA Specifications.
- c. The equipment for proper prosecution of the work shall be at the work site and approved by the CenterPoint Energy’s Representative prior to the beginning of construction operations.
- d. The Contractor shall maintain on the job site, at all times, a complete and readable copy of all specifications and any drawings provided by CenterPoint Energy governing the subject paving installation.
- e. No deviation from this specification will be permitted without authorization from CenterPoint Energy.

12.3 MATERIAL ESTIMATES

- a. The quantities indicated on the CenterPoint Energy’s drawings are estimated by CenterPoint Energy utilizing plan dimensions, and shall be verified by the Contractor. If the Contractor detects any discrepancies in the quantities estimated by CenterPoint Energy, he should amend the figures on the inquiry sheet to reflect the quantities he has estimated. The quantities shown on the inquiry sheet by CenterPoint Energy, or as amended by the Contractor, shall be the quantities which appear on the purchase order when issued and will be the quantities for which the Contractor will be paid.

SPECIFICATION			
SHEET 26		of 35 SHEETS	
SPEC ID	007	231	79

12.4 SCHEDULING

- a. The Contractor shall state in his proposal the number of working days required to complete the job.
- b. The Contractor shall give CenterPoint Energy notice 72 hours prior to the start of construction.
- c. All work shall be performed between the hours of 7:00 a.m. to 7:00 p.m. Work shall not be performed on Saturdays or holidays without a 48 hour advance approval by CenterPoint Energy. Work shall not be performed on Sundays.

12.5 GRUBBING AND EXCAVATION

- a. The area to be paved shall be excavated and shaped to conform with the typical sections shown on the paving drawing.
- b. The area to be paved shall be "cleared and grubbed" removing and disposing of all trees, stumps, brush, roots and stripped of all vegetation, logs, rubbish and other undesirable matter to a depth of four (4) inches.
- c. Very soft or unstable soils that are deemed unfit due to high humus content, high water content, low density, etc., shall be removed to a depth determined by CenterPoint Energy.
- d. All holes, ruts and depressions shall be filled with material approved by the CenterPoint Energy's Representative.
- e. The Contractor shall not use excavated material as fill material without specific authorization from the CenterPoint Energy's Representative.
- f. The Contractor shall exercise care when grading, to stay clear of power lines, structures, pipes, septic tanks, fences or any underground facilities installed prior to the road and/or paving construction.
- g. The Contractor shall reimburse CenterPoint Energy for the repair or replacement of any of the previously mentioned equipment he damages.

12.6 SELECT FILL MATERIAL

- a. Select fill material shall conform to a CL (clay) or SM (sand) soil classification designated in ASTM D-2487 unless otherwise approved by the CenterPoint Energy's Representative.

SPECIFICATION			
SHEET 27		of 35 SHEETS	
SPEC ID	007	231	79

- b. Select fill material shall meet the following Atterberg limits:

Class A Fill Material

Liquid Limit 30-45  
Plasticity Index 7.5 – 15

Class B Fill Material

Maximum Liquid Limit 35  
Maximum Plasticity Index 20

12.7 SOIL STERILANTS

- a. When required, Krovar-1 and Dowpon soil sterilants shall be applied to the area to be paved at the rate of 30 lbs. of Krovar-1 and 30 lbs of Dowpon in 200 gallons of water per acre.
- b. The soil sterilants shall be applied by a state licensed applicator.
- c. The Contractor shall notify the CenterPoint Energy's Representative 48 hours prior to applying soil sterilants so that spraying operation may be inspected.
- d. Failure to abide by this shall be cause for the Contractor to re-spray the designated area at his expense.

12.8 CEMENT STABILIZED SOIL

- a. Soil that CENTERPOINT ENERGY requires to be stabilized with cement shall be done in accordance with THD Standards, Item 270.
- b. The entire area shall be stabilized to the depth shown on the CenterPoint Energy's paving drawings prior to the placement of the fill material.
- c. The amount of Portland cement will be specified by CenterPoint Energy as required by the soil conditions.
- d. The Contractor shall assume full responsibility for damage resulting from cement that has washed or blown off the subgrade.

SPECIFICATION			
SHEET 28 of 35 SHEETS			
SPEC ID	007	231	79

12.9 LIME STABILIZED SOIL

- a. Soil that CenterPoint Energy requires to be stabilized with lime shall be done in accordance with THD Standards, Items 260 and 264.
- b. The lime shall be furnished and spread as dry lime.
- c. The road and yard areas shall be stabilized to the depth shown on the paving drawings upon completion of grubbing operations and prior to the placement of any select fill.
- d. The amount of lime stabilization will be specified by CenterPoint Energy as required by the soil conditions.
- e. Sprinkling may be employed to reduce dusting problems during spreading, but excessive wetting of the lime shall be avoided until mixing operations commence.
- f. The Contractor shall assume full responsibility for damages resulting from lime that has washed or blown off the subgrade.

12.10 COMPACTION REQUIREMENTS

- a. All select fill material, stabilized soil, existing yard paving and excavated areas shall be compacted to 95% density as established by the Standard Proctor Density Test with moisture content within 2% optimum.
- b. The select fill material shall be compacted in lifts not to exceed eight (8) inches.
- c. The CenterPoint Energy's Representative shall approve the equipment the Contractor proposes to use for compaction of the fill material.
- d. CenterPoint Energy will check the in-place density using Nuclear Test Methods.

12.11 FORMING

- a. The forms for the paving shall be constructed of Southern yellow pine treated with pentachlorophenol.
- b. The pentachlorophenol solution shall be in accordance with AWPA P8 and AWPA P9, and shall contain a minimum of 5% pentachlorophenol by weight as determined by AWPA A5.
- c. The preservative treatment shall be by the Empty-Cell Process in accordance with AWPA C1 and C2.

SPECIFICATION			
SHEET 29 of 35 SHEETS			
SPEC ID	007	231	79

- d. The lumber shall be treated to 0.40 pounds per cubic foot final net retention of pentachlorophenol by assay.
- e. The forms shall be installed in accordance with the plans and shall be true in both horizontal and vertical planes.
- f. The forms shall be of the size, shape and type indicated on the plans.
- g. Forms and stakes shall be of sound heartwood and shall be free of knots, clustered birdseye, checks, splits, and sapwood. Occasional sound or hollow birdseye when not in clusters will be permitted, provided the board is free from any other defects that will impair its usefulness as a form.
- h. Any forms damaged beyond repair due to the Contractor's negligence shall be replaced at his expense.

12.12 CONCRETE PIPE

- a. All concrete pipe shall be constructed in accordance with ASTM C-14, Tongue and Groove.
- b. All reinforced concrete pipe shall be constructed to comply with ASTM C-76, Class IV, Wall B, Reinforced Concrete Pipe.

12.13 GRASS SEEDING

- a. The substation site shall be seeded with hulled Bermuda at the rate of 110 pounds per acre. Gulf Coast Rye shall also be planted with the Bermuda when the ground is 70°F or below. When Bermuda and Gulf Coast Rye are planted together they shall be proportioned as follows:

Bermuda:           50 pounds per acre  
Gulf Coast Rye:   100 pounds per acre

- b. Seeding shall not be performed when the wind velocity would be detrimental to the uniform distribution of the seed.
- c. The area to be seeded shall be lightly raked to provide a seed bed.
- d. The required seed mixture shall be sown uniformly in accordance with the Manufacturer's recommendations.
- e. After sowing, the area shall be evenly raked to provide cover for the seeds.
- f. The lawn area shall be watered in a manner so as not to cause surface erosion.

SPECIFICATION			
SHEET 30 of 35 SHEETS			
SPEC ID	007	231	79

12.14 AGGREGATES

- a. The aggregates for the base and sub-base shall consist of one or more of the following: shell, sand, gravel, limestone, or granite gravel.
- b. The aggregates when properly slaked and tested shall conform to the following size requirements:

<u>AGGREGATE TYPE</u>	<u>U.S. STANDARD SIEVE SIZE</u>	<u>PERCENT RETAINED BY WEIGHT</u>	<u>MAX. LIQUID LIMIT</u>	<u>MAX. PLASTIC INDEX</u>
Oyster Shell	2"	0-12%	35	12
	7/8"	12-37%		
	No. 40	50-85%		
	No. 200	88-100%		
Sand	No. 10	0-5%	--	--
	No. 20	5-20%		
	No. 50	75-90%		
	No. 100	95-100%		
Gravel	1 3/4" Screen	0-10%	35	12
	No. 4	30-75%		
	No. 40 Mesh Sieve	70-85%		
Shell and Sand	1 3/4 " Sieve	0-10%	35	12
	No. 4 Sieve	40-65%		
	No. 40 Sieve	50-75%		
Limestone	1 3/4" Sieve	0	40	12
	3/4" Sieve	15-45%		
	No. 4 Sieve	45-75%		
	No. 40 Sieve	60-85%		
Granite Gravel	3/8" to 3/4" Sieve	10-15%	32	14
	No. 4	15-25%		
	No. 8	40-55%		
	No. 16	55-70%		
	No. 40	65-90%		

- c. Local material suppliers shall be approved by CenterPoint Energy.
- d. The aggregate shall be free from excess salt, alkali, vegetable matter, clay or otherwise objectionable matter.

SPECIFICATION			
SHEET 31 of 35 SHEETS			
SPEC ID	007	231	79

- e. At the discretion of CenterPoint Energy, the following THD test methods will utilized to verify compliance with these specifications:
  1. Tex-101-E, Preparation of Soil & Flexible Base material for Testing
  2. Tex-104-E, Liquid Limit
  3. Tex-106-E, Plastic Index
  4. Tex-110-E, Sieve Analysis

12.15 CEMENT

- a. Cement shall be Type 1 of a standard brand of Portland cement and shall conform to the requirements of ASTM C-150.

12.16 GROUND BOXES

- a. Ground boxes will be set by CenterPoint Energy before final grading. The Contractor shall set the ground boxes to finish grade.
- b. The Contractor shall set ground boxes to grade over base line monuments.

12.17 STABILIZED BASE COURSES

- a. The approximate combination of aggregates stabilized with Portland cement or flue dust may be provided for the base or subbase in accordance with the following percent mixtures:

<u>Cement-Dual Base</u>	<u>Cement-Tri-Base</u>	<u>Flue Dust-Dual Base</u>
Oyster Shell 60%	Oyster Shell 30-55%	Oyster Shell 60%
Sand 33%	Gravel 18-35%	Sand 33%
Cement 7%	Sand 35-45%	Flue Dust 7%
	Cement 1.17-7%	

- b. The percent of Portland cement in the Cement-Dual Base and the percent of flue dust in the Flue Dust-Dual Base shall be to the exact proportion give n above.
- c. The percent of Portland cement in the Cement-Tri-Base will range from 1.17-7%, with the actual proportion given in the CenterPoint Energy purchase order.
- d. The Portland cement or flue dust stabilized base courses shall not be mixed or placed when the air temperature is 40°F (or below) and falling.

SPECIFICATION			
SHEET		32 of 35 SHEETS	
SPEC ID	007	231	79

12.18 MIXING

- a. The cement, aggregate and water shall be thoroughly mixed in a pugmill type mixer approved by CenterPoint Energy.
- b. The plant shall be equipped with feeding and metering devices which will add the aggregate, cement or flue dust and water into the mixer in the specified quantities.
- c. The moisture content of the mixture shall be maintained between optimum moisture and two percentage points above optimum moisture to protect against dehydration during shipment.
- d. The optimum moisture content and desirable density shall be determined by the Texas Highway Department test Method Tex-114-E, latest revision, and checked in the field by the Nuclear Method.

12.19 CONSTRUCTION METHODS

- a. The Contractor shall apply the base in lifts of not more than 6" or less than 3".
- b. After each lift is spread, it shall be sprinkled and rolled to secure maximum compaction with succeeding layers placed similarly until the course is completed. The material shall be tamped with floats and/or rolled with a roller weighing not less than three (3) tons.
- c. All areas and "nests" of segregated coarse or fine material shall be corrected or removed and replaced with well-graded material, then be sprinkled as required and rolled until a uniform compaction is secured.
- d. All irregularities, depressions or weak spots which develop shall be corrected immediately by scarifying the areas affected, adding suitable material as required, reshaping and recompacting.
- e. When the uncompacted stabilized base mixture is wetted by rain so that at the time of final compaction the average moisture content exceeds the range specified in the test, the entire section shall be removed or additional stabilizer shall be added at the Contractor's expense.
- f. The stabilized base shall be compacted to a density of not less than 95 percent of compaction ratio density as established by the Standard Proctor Density Test. After completion of compaction, the surface that forms the ramp shall be thoroughly wetted and slush rolled to work sufficient mortar to the surface to provide a broom finish for the ramp.

SPECIFICATION			
SHEET 33 of 35 SHEETS			
SPEC ID	007	231	79

- g. Prior to each day's construction, a straight joint shall be formed by cutting back into the entire depth of completed work to form a true vertical face free of loose and shattered material.
- h. The stabilized base shall be protected against rapid drying for a period not less than three days.
- j. After the final course of the stabilized base is compacted, the surface shall be finished to grade and section by blading and shall be sealed with approved pneumatic tire or flat wheel rollers.
- k. The finished shape of the course shall be smooth and conform to the typical sections shown on plans, and to the established lines and grades. The surface shall be finished to a tolerance of 1/2 inch in ten (10) feet under a straight edge.
- l. Not more than two (20 hours shall elapse between the start of mixing and the time of starting the compaction of the stabilized base on the prepared subgrade.
- m. The compaction shall be completed within six (6) hours of the time water is added to the mixture.
- n. The CenterPoint Energy's Representative may at his/her option reject any stabilized material that is not in accordance with this specification.
- o. The Contractor shall erect and maintain sufficient barricades to prevent traffic on the newly paved area(s) for a period of 72 hours.

12.20 GRADING

- a. The Contractor shall surface grade the entire substation property including drainage facilities to provide a smooth finish and good drainage.
- b. In the event the paving installation is performed in two phases, the Contractor shall surface grade the substation area after each phase.
- c. When grading, it shall be the Contractor's responsibility to stay clear of power lines and structures. When pipes, septic tanks, or any other underground facilities have been installed prior to road and paving construction, care shall be taken to avoid damage during construction. If these structures are damaged due to the Contractor's negligence, they shall be replaced at his expense.

SPECIFICATION			
SHEET		34 of 35	SHEETS
SPEC ID	007	231	79

12.30 JOB COMPLETION

- a. The Contractor shall remove all debris, scrap material, broken asphalt or concrete and any other objectionable material.
- b. Private property that was damaged during construction shall be repaired, replaced or otherwise corrected at the Contractor's expense.
- c. The unpaved areas shall be sufficiently smooth to allow machine mowing and drainage of all areas.
- d. All clean-up work and surface grading shall be complete before the final inspection by the CenterPoint Energy's Representative.

SPECIFICATION			
SHEET	35	of	35 SHEETS
SPEC ID	007	231	79

## EXHIBIT "C"

### MINIMUM INSURANCE REQUIREMENTS

#### 1.1 Insurance Requirements

1.1.1 Grantee agrees to procure and to maintain in full force and effect, at Grantee's sole expense, insurance of the following types and amounts, written by insurance companies satisfactory to Grantor, authorized to do business in the state where the work is being performed, and having an A.M. Best's Rating of not less than "A- VII":

#### 1.2 Workers' Compensation and Employers' Liability

1.2.1 Grantee shall carry statutory Workers' Compensation Insurance covering Grantee's employees in compliance with all requirements of the Workers' Compensation laws of all states in which Grantee performs work hereunder.

1.2.2 In addition, Grantee shall carry Employer's Liability Insurance covering all operations and work hereunder in an amount not less than the following:

Each Accident	\$1,000,000
Each Disease Each Employee	\$1,000,000
Disease Policy Limit	\$1,000,000

1.2.3 In addition, Grantee shall carry insurance in compliance with the U.S. Longshoreman's and Harbor Worker's Act, Outer Continental Shelf Act and covering Jones Act liability, if Grantee's performance hereunder involves marine exposures.

#### 1.3 General Liability Insurance

1.3.1 Grantee shall carry general liability insurance on a form no less broad than the coverage provided by a "Commercial General Liability Insurance" form (dated 2004 or thereafter) promulgated by the Insurance Services Office, and containing language affording coverage for contractual liability, the products and completed operations hazards, broad form property damage liability, and the explosion, collapse and underground hazards, as respects all operations and work hereunder, for all liability arising out of injury to or death of one or more

persons, and injury to or destruction of property, in any one occurrence, in amounts not less than:

General Aggregate	\$2,000,000
Products – Completed /Operations Aggregate	\$1,000,000
Personal & Advertising Injury	\$1,000,000
Each Occurrence	\$1,000,000

1.4 **Automobile Liability Insurance**

1.4.1 Grantee shall carry Automobile Liability Insurance on a form no less broad than the coverage provided by a Business Automobile Liability Insurance form (dated 1985 or thereafter) promulgated by the Insurance Services Office, on all owned or hired autos, as well as non-owned autos, in an amount not less than \$1,000,000 combined single limit, for all liability arising out of injury to or death of one or more persons, and injury to or destruction of property, in any one occurrence.

1.5 **Pollution Liability Insurance**

1.6 **Pollution Liability Insurance - Grantee shall purchase and maintain Grantee's pollution liability insurance coverage for any and all losses arising from or in any way related to pollution conditions, both sudden and accidental and gradual, which arise from Grantee's operations under this Consent to Encroach document, whether directly or indirectly, or that are in any other way related to Grantee's operations during use and performance of this occupation, whether such operations be by Grantee, its contractors, subcontractors or anyone directly or indirectly employed by any of them.**

1.7 Intentionally left blank

1.8 **The Grantee's pollution liability insurance policy shall contain minimum liability limits of \$10,000,000 per claim and \$10,000,000 in the aggregate. Such liability limits shall be project specific, dedicated to the work to be performed by Grantee under the Consent to Encroach document and shall not be eroded by the addition of any other party or entity not in conformance with the Consent to Encroach document.**

1.9 **The policy shall satisfy the following minimum requirements:**

1.10 **"Covered Operations" designated by the policy must specifically include all work performed under this Consent to Encroach document.**

1.11 **The policy shall contain or be endorsed to include coverage for the following:**

- (i) **bodily injury (including death), property damage and environmental cleanup costs, both on-Site and off-Site;**
- (ii) **transportation of any waste, including loading/ unloading, from the Site to the final disposal location as well as any temporary storage, transshipment or**

- transfer sites. Transportation coverage shall include owned, hired and non-owned automobiles; and
- (iii) all disposal locations (final and temporary). All such disposal locations shall be covered by the policy as non-owned disposal sites;
- i. Shall not exclude any loss or damage to Grantor or Grantor's property resulting from any acts or omissions of Grantee, its officers, employees, agents, servants or subcontractors.
  - ii. Shall not contain any exclusions for microbial matter, lead or asbestos.
  - iii. Shall not contain any contractual liability exclusion or any other similar exclusion which would serve to exclude coverage for liability assumed by the Grantee under the Agreement.

1.12 **Excess Liability Insurance**

1.12.1 Grantee shall carry Excess Liability Insurance that follows the form of the underlying primary liability insurance required by Employers Liability only, General Liability, and Automobile Liability, in an amount not less than \$10,000,000 per occurrence and \$10,000,000 in the aggregate.

1.13 **Deductibles**

1.13.1 Any and all deductibles, or self-insured retentions, of all insurance policies required hereunder shall be assumed by, for the account of, and at the Grantee's sole risk and expense, and shall not be billed to or payable by Grantor, or its direct and indirect subsidiaries and affiliates, including limited liability companies.

1.14 **Additional Insureds**

1.14.1 The insurance required by General Liability, Automobile Liability, and Excess Liability Sections shall include Grantor, including its direct and indirect subsidiaries and affiliates including Limited Liability Companies, as additional insureds, to the extent allowed by law, with respect to all operations and work hereunder, as to the full limits of liability purchased by Grantee (including limits greater than the minimum limits required herein), and shall include language providing:

1.14.1.1 That such insurance applies separately to each insured against whom claim is made or suit is brought; and

1.14.1.2 That such coverage to Grantor, including its subsidiaries and affiliates, no less broad than one or the other of the following alternatives: (a) the coverage afforded to the named insured under the policy with respect to the work or services to be performed hereunder; or (b) the coverage afforded by the combination of Insurance Services Office Endorsements' CG 20 33 07 04 (entitled "Additional Insured – Owners, Lessees or Grantees – Automatic Status When Required in Construction Agreement with You) and CG 20 37 07 04 (entitled "Additional Insured – Owners, Lessees or Contractors – Completed Operations"); and,

1.14.1.3 That such insurance shall respond as primary insurance and shall not contribute with any other valid and collectible other insurance that may be maintained by Grantor, or its direct and indirect subsidiaries and affiliates.

1.15 **Waiver of Subrogation**

1.15.1 The insurance required by Workers Compensation and Employers' Liability, General Liability, Automobile Liability, Excess Liability (if applicable), Cyber Liability (if applicable), Pollution Liability (if applicable), Rigging (if applicable), Aircraft (if applicable), and Professional Liability (if applicable) Sections shall include full Waivers of Subrogation in favor of Grantor, including its direct and indirect subsidiaries and affiliates and Limited Liability Companies, unless Waiver of Subrogation is prohibited by the law governing such insurance. For the avoidance of doubt, Grantee agrees that it presently releases all claims against Grantor that may arise in the future within the scope of the subrogation waiver required by this paragraph."

1.16 **Certificates of Insurance**

1.16.1 Grantee shall furnish Grantor with Certificates of Insurance signed by Grantee's insurance agent, showing Grantee's procurement of the insurance required hereunder. Each such Certificate shall accurately reflect insurance in place, shall be in a form satisfactory to Grantor, and shall contain language:

1.16.1.1 Expressly and specifically referring to the this Consent to Encroach document and, Grantor's unique reference job reference number; (the Consent to Encroach document to which this is attached);

1.16.1.2 A copy of the cancellation provisions and in addition to the certificate Grantee shall provide thirty (30) days written notice (except ten (10) days written notice in the case of nonpayment of premium) to the Grantor prior to cancellation of or material change in the coverage;

1.16.1.3 Confirming that Grantor, including its direct and indirect subsidiaries, affiliates and Limited Liability Companies, are Additional Insureds, as required by Additional Insureds Section hereof;

1.16.1.4 Confirming Waiver of Subrogation in favor of Grantor, including its direct and indirect subsidiaries, affiliates and Limited Liability Companies, as required by the Waiver of Subrogation Section hereof; and,

1.16.1.5 Attaching the language or endorsement(s) by which Grantor including its direct and indirect subsidiaries, affiliates, and Limited Liability Companies is made an additional insured and coverage is primary and non-contributing.

1.16.2 Grantee warrants the complete accuracy of all information provided on every Certificate of Insurance provided by Grantee, or provided by Grantee's agent or broker, to Grantor. Grantee agrees to assure that Grantor receives in fact the notifications required in paragraph reading: "A copy of the cancellation provisions and in addition to the certificate Grantee shall provide thirty (30) days written notice (except ten (10) days written notice in the case of nonpayment of premium) to the Grantor prior to cancellation of or material change in the coverage" above.

1.16.3 Grantee agrees to provide Grantor with true, correct and complete photo / electronic copies, or to make available for inspection the originals, of all policies of insurance that Grantee is required to procure and maintain in force under this Consent to Encroach document within three (3) business days after receipt of Grantor's request.

1.17 **Claims-Made Insurance**

1.17.1 If the insurance required hereunder is procured on a form affording claims-made coverage, then (i) all limits stated above as "per occurrence" shall be understood to mean "per claim" or "per occurrence," as is consistent with the terms of the claims-made policy; and, (ii) such claims-made insurance shall not provide for a retroactive date later than the commencement of Grantee's performance hereunder. All insurance as required herein shall be primary to any other insurance coverage purchased and shall be issued by an insurer authorized to do business in the state where the work is being performed.

1.18 **Reinstatement of Impaired Limits**

In the event that the required aggregate limits of liability of any insurance required hereunder are reduced or impaired by 50% or more, then Grantee shall give Grantor notice of the impairment and promptly cause such impaired limits to be reinstated to the required limits.

1.19 **Subcontractors' Insurance**

1.19.1 Grantee shall cause its Subcontractors, including all persons hired by Grantee who are not Grantee's employees, who perform any part of the Work hereunder, to procure and to maintain in full force and effect insurance of the types and amounts, and meeting all the requirements of Grantee.

1.20 **Term of Required Insurance**

1.20.1 All terms of these insurance requirements shall survive termination of this Consent to Encroach **document** and shall continue until all facilities are removed from Grantor's Property , including the performance of any warranty work. In addition, Grantee shall maintain in force and effect completed operations coverage under the insurance policies required by General Liability and Excess Liability (if applicable), and any "claims-made" coverage within Claims-Made Insurance Sections, for a minimum of two (2) years after final removal or abandonment. Grantee shall purchase an extended reporting period, or "tail coverage," if necessary to comply with the latter requirement.

1.21 **No Waiver by Grantor should this be by Grantee**

1.21.1 Grantee's failure to provide insurance as required hereunder, or Grantee's failure to supply Certificates of Insurance that comply with Certificates of Insurance Section, above or the failure of Grantor to require evidence of insurance or to notify Grantee of any breach by Grantee of the requirements of these provisions or deficiencies in the insurance obtained, shall neither constitute a waiver by Grantor of any of the these Insurance Requirements, nor a waiver of any other terms and conditions of the Consent to Encroach document, including Grantee's obligations to defend, indemnify to the extent allowed by law, and hold harmless Grantor (including subsidiaries and affiliates), as required herein.

FILED AND RECORDED  
OFFICIAL PUBLIC RECORDS

*Laura Richard*

Laura Richard, County Clerk

Fort Bend County Texas

October 06, 2020 03:54:39 PM

FEE: \$0.00

DP2

2020138376

