

**LEASE AGREEMENT  
RFP 17-043**

THIS LEASE AGREEMENT made this day by and between **FORT BEND COUNTY**, a body corporate and politic under the laws of the State of Texas, by and through its Commissioners Court, hereinafter referred to as "Lessor," and **Clear Wireless LLC, a Nevada limited liability company**, authorized to do business in the State of Texas, hereinafter referred to as "Lessee."

WHEREAS, the Lessor is the owner of the building located in Fort Bend County, Texas, and further described in Exhibit A, attached hereto and made a part hereof for all purposes, hereinafter referred to as "Leased Premises"; and,

WHEREAS, Lessee desires to lease a portion of the Leased Premises for the purpose of operation, installation and maintenance of certain cellular telephone antenna and related equipment, along with restricted ingress and egress thereto, and utility and cable easements thereto; and,

WHEREAS, Lessor represents that such lease of County property is authorized pursuant to RFP 17-043.

NOW THEREFORE, in consideration of the terms, conditions and rentals hereinafter set forth, Lessor and Lessee agree to the following:

**WITNESSETH, THAT**

**1.  
USE**

The Leased Premises are hereby leased to Lessee as a site for a wireless communications facility and for any other lawful purpose, consistent with related applications, for which Lessee may desire to use the Leased Premises. Lessee shall have the right to erect, construct, operate, maintain, repair and replace on the Leased Premises the equipment described in Exhibit A – Product Specifications. Within the confines of the equipment footprint, Lessee shall have the right to erect, construct, operate, maintain, repair and replace on the Leased Premises the equipment described in Exhibit A. Lessee agrees and shall be required to light the communications monopole or tower, if any, in the manner required by the Federal Aviation Agency for structures 200' or higher. **Only the items listed in Exhibit A are allowable on the Leased Premises. Any additional structures, antennae, footprints, equipment, cabinets of any kind, and/or any other items not specifically contained in Exhibit A and authorized by Lessor are strictly prohibited. Lessee's failure to comply with the requirements of this paragraph shall constitute a default of this**

**Lease Agreement and call for the immediate cancellation and termination of this Lease Agreement. Should Lessee breach any material term or covenant of this paragraph, and such breach shall continue uncured for thirty (30) days following Lessee's receipt of written notice of such breach, Lessor shall have the right and authority to remove any and all structures, antennae, footprints, cabinets of any kind, or any other item placed/installed on the Leased Premises. Lessor shall not be responsible for any damage to any structures, antennae, footprints, equipment, cabinets of any kind, and/or any other item removed from the Leased Premises in the event of Lessee's default. Notwithstanding the foregoing, Lessee shall have the right to cure any default as provided under paragraph 8(b) of this Lease Agreement.**

Lessee is hereby granted the limited right of ingress and egress to the Leased Premises during normal business hours of 8:00 a.m. to 5:00 p.m. of Lessor for the purpose of installation, maintenance, repair, replacement and removal of the communications tower and other equipment. Lessee shall have limited access to the Leased Premises at times when the Lessor's business activity is closed, such as after 5:00 p.m., weekends and holidays. In the event Lessee requires access to the Leased Premises after hours, Lessee shall contact Lessor no less than four (4) hours prior to being granted access to the Leased Premises. If Lessee requires access to the Leased Premises outside of Lessor's normal business hours, Lessee will be responsible for any reasonable costs incurred by Lessor in providing such access.

Subject to the provisions of Paragraph 13 hereof, any and all structures, improvements, equipment, facilities and other property of whatever kind installed by or for Lessee on the Leased Premises shall be and remain the property of Lessee, whether affixed to the realty or not, and Lessee shall have the right to remove the same at any time during the term hereof and within 90 days after the termination or expiration of this Lease Agreement or any extensions or renewals thereof. All the while, rent shall continue to be paid to Lessor until the removal of the property.

Lessee agrees and understands that it is the Lessee's responsibility to abide by all federal, state and local rules and regulations pertaining to the operation of the site and of Lessee's equipment; including without limitations, those pertaining to the installation, maintenance, height, location, use, operation, and removal of its equipment, antenna systems, and any other alterations or improvements authorized herein. Lessee agrees and understands that changes in rules and policies by agencies or persons other than Lessor that affect the operation or use of Lessee's equipment and of the site are not Lessor's responsibility. Lessee hereby represents that Lessee has obtained the necessary licenses and permits required to use said site, or that Lessee will obtain said licenses or permits, at Lessee's own expense, prior to any such use.

Lessee represents that it has independently ascertained that the site is adequate and proper for Lessee's intended use and has entered into this Lease Agreement based solely upon said independent investigation, and not by any representation by Lessor.

## **2. TERM**

This Lease Agreement shall be for a primary term ("Primary Term") of one (1) year, commencing on the date executed by the Lessee or Lessor, whichever is later the ("Commencement Date") and ending on the first anniversary of that date; provided, however, Lessee shall have the right and option to extend the term of this Lease Agreement for four (4) additional one (1) year periods, commencing on the first (1<sup>st</sup>) anniversary date of this Lease Agreement (the "Renewal Period") with a three percent (3%) annual increase for each renewal. In no event shall this Lease Agreement extend past December 31, 2022. Lessor shall have the right to terminate this Lease Agreement by providing Lessee ninety (90) days written notice prior to any anniversary date.

## **3. UTILITIES**

Lessee agrees to pay Lessor, in advance, for power consumption at the Leased Premises, a utility fee ("Utility Fee") in monthly installments of One Hundred Fifty and No/100 Dollars (\$150.00). The Utility Fee payments will begin on the Commencement Date and shall continue during the term until this Lease Agreement terminates for any reason, partial months to be prorated. If the Commencement Date is any day other than the first day of a calendar month, then subsequent payments of the Utility Fee will not be due until the first day of the first calendar month following the Commencement Date. Lessor will read the submeter on a monthly basis and annually reconcile actual consumption against the Utility Fee paid for that year. If the actual power consumption for the Leased Premises or the local public utility rates for that 12-month period produce a utility cost amount which is more than the Utility Fee paid by Lessee for that period, and Lessor can provide written third-party documentation of the overage, then Lessor may invoice Lessee for any difference between the two amounts within 60 days from the annual anniversary of the Commencement Date. If the actual power consumption for the Leased Premises or the local public utility rates for that period produce a utility cost amount which is less than the Utility Fee paid by Lessee for that period, then Lessee may either, at Lessee's sole discretion, apply a credit against the next Utility Fee payment due for any difference between the two amounts or receive a prompt refund from Lessor of any overpayment.

## **4. COMPLIANCE WITH LAWS**

Lessee agrees, at its expense, to conduct all operations on said Leased Premises in full compliance with all laws, ordinances, rules, regulations, orders or directives of any government authority, and shall not commit or allow to be committed any public or private nuisance thereon.

**5.  
WARRANTY**

Lessor warrants that Lessor owns fee simple title to the Leased Premises, or has the authority to assign or sublet a previously executed lease, and that the leasehold estate herein created is and shall be free and clear of all liens and other encumbrances. Lessor warrants that this Lease Agreement includes access to the Leased Premises.

**6.  
COVERAGE AND INTERFERENCE**

Lessor makes no representations concerning the distance at which useable signals may be transmitted and received from the site or location thereof. Lessee is hereby notified that the site is subject to degradation performance from, but not limited to, natural and man-made phenomena such as so-called "skip" interference, power line and ignition noise, intermodulation, co-channel interference, and interference from users of the same or other radio frequencies. Lessor is not responsible for interference due to the above or other causes.

**7.  
RENTAL**

As rent and rental for the use of the Leased Premises, Lessee shall pay to Lessor the annual sum of **\$24,000.00**, within 30 days of full execution of this Lease Agreement. Any overpayments from the previous lease for this site shall be credited against the amount due. This rental rate will be increased annually effective on the anniversary of the Commencement Date each year by three (3%) as follows:

Year 1 (2017 to 2018)	\$ 24,000.00
Year 2 (2018 to 2019)	\$ 24,720.00
Year 3 (2019 to 2020)	\$ 25,461.60
Year 4 (2020 to 2021)	\$ 26,225.45
Year 5 (2021 to 2022)	\$ 27,012.21

Each renewal period shall automatically commence immediately upon the expiration of the prior term or renewal period, unless Lessee provides at least thirty (30) days prior written notice to Lessor of its intent not to exercise the

renewal period. All future rental payments due hereunder shall be paid or tendered to Lessor at Lessor's address specified herein, or to such other place as Lessor may from time to time designate the Lessee on or before the anniversary of the Commencement Date each year Lessee seeks to renew this Lease Agreement. No change of ownership with respect to the Leased Premises or with respect to the rental payments provided for herein shall be effective and binding upon Lessee for any purpose until thirty (30) days after the acquiring party shall have furnished Lessee by registered United States Mail, a copy duly certified by the appropriate public official, of the recorded instrument, if any.

Failure on the part of Lessee to make any rental payment hereunder on or before its due date shall give Lessor the right (following written notice and an opportunity to cure as provided below) to declare a forfeiture of this Lease Agreement, which declaration of forfeiture shall be made in writing and shall be mailed or delivered to Lessee at the address specified herein (or to any subsequent address hereafter specified by Lessee). This Lease Agreement and all rights of Lessee hereunder shall terminate thirty (30) days after receipt by Lessee of such written declaration of forfeiture, unless on or before the expiration of such thirty (30) day period the Lessee shall pay to Lessor the rental then owing hereunder.

## **8. TERMINATION**

- A)** Lessee may terminate this Lease Agreement at any time by giving thirty (30) days written notice to Lessor of its intention to do so.
- B)** Lessor may terminate this Lease Agreement if Lessee shall default in the payment of any rent or fails to comply with the material provisions or conditions of this Lease Agreement, and in either event, if such default shall continue for a period of thirty (30) days after written notice given by Lessor to Lessee specifying such default.
- C)** Lessor may terminate this Lease Agreement at any time by giving ninety (90) days written notice to Lessee.
- D)** Rent shall continue until all personal property of the Lessee is removed and any damages repaired.
- E)** Lessor may terminate this Lease Agreement if at any time Environmental Hazards are caused by Lessee's activities.

## **9. INSPECTION AND ACCESS**

Lessor shall be afforded unlimited access to the site and/or to Lessee's equipment for inspection purposes and Lessee shall furnish Lessor with a key or the combination of any lock securing the site and/or Lessee's equipment.

**10.  
ASSIGNABILITY**

Lessee will not assign or transfer this Lease Agreement or sublet all or any portion of the Leased Premises without prior written consent of Lessor, which consent will not be unreasonably withheld, conditioned or delayed; provided however, that Lessee shall have the right, without notice to or consent of Lessor, to sublease (or otherwise transfer or allow the use of) all or any portion of the Leased Premises or assign its rights under this Lease Agreement in whole or in part to: (a) any entity controlling, controlled by or under common control with Lessee; (b) any entity acquiring substantially all of the assets of Lessee; (c) any entity that is authorized to sell telecommunications products or services under the "Sprint" or "Sprint PCS" or "Nextel" brand name or any successor brand name(s) or other brand name(s) used or licensed by Lessee's parent corporation ("Contract Affiliate"); or (d) any successor entity in a merger or consolidation involving Lessee. Lessor will not be entitled to any additional rent or other fees for its review or approval.

**11.  
ACCEPTABLE ENCUMBRANCES**

Notwithstanding the terms and provisions of Paragraph 5 hereof, this Lease Agreement is made expressly subject to certain valid and existing easements, leases, rights of way, oil, gas and mineral rights, and restrictions which are presently of record.

**12.  
DEFAULT**

If Lessee fails to comply with any material provisions of this Lease Agreement and such failure is not cured within thirty (30) days after receipt of written notice thereof from Lessor, Lessor may, at its option, terminate this Lease Agreement without affecting any rights to which Lessor may be entitled. If any such default cannot reasonably be cured within thirty (30) days, Lessee will not be deemed to be in default hereunder if Lessee commences curing such default within the thirty (30) day period and thereafter diligently pursues such cure to completion. However, in no event shall any default remain uncured for a period of sixty (60) days.

If Lessor fails to comply with any material provisions of this Lease Agreement and such failure is not cured within thirty (30) days after receipt of written notice thereof from Lessee, Lessee may, at its option, terminate this

Lease Agreement without affecting any rights to which Lessor may be entitled. If any such default cannot reasonably be cured within thirty (30) days, Lessee will not be deemed in default hereunder if Lessor commences curing such default within the thirty (30) day period and thereafter diligently pursues such cure to completion.

**13.**  
**REMOVAL OF PROPERTY**

Lessee shall have the right at any time during or within ninety (90) days after the termination of this Lease Agreement to dismantle and remove all property and improvements placed by Lessee on the Leased Premises or on the lands of Lessor adjacent and contiguous to the Leased Premises, regardless of the manner in which such property and improvements may be affixed thereto; provided, however, that said premises shall be restored to substantially their original condition insofar as it is reasonably practicable to do so, reasonable wear and tear excepted, or, if mutually agreed upon, it may transfer such property to Lessor and leave the same in place as abandoned property. Lessee is responsible for the removal and replacement of Lessee's property and improvements due to maintenance and/or repairs to the Leased Premises required by Lessor. Lessee is required to repair any damage to the Leased Premises upon termination of this Lease Agreement. Lessee shall be responsible and held liable for any and all Environmental Hazards caused by Lessee's activities and shall remove any and all such Environmental Hazards to Lessor's satisfaction.

This Lease Agreement shall be binding upon and inure to the benefit of the parties hereto and their respective heirs, successors, assigns and legal representatives (where assignment is allowed). This Lease Agreement may be executed in counterparts, each of which shall be considered an original of this instrument, and all of which shall constitute one and the same instrument. This Lease Agreement may be ratified by separate instruments referring hereto and shall be binding upon each party who executes or ratifies it without regard to whether it is executed or ratified by all those named herein as Lessor or Lessee, or whether such executing or ratifying party is named herein as a lessor or lessee.

**14.**  
**INSURANCE AND INDEMNITY**

Lessor provides no insurance on Lessee's equipment. Lessee agrees to furnish Lessor with Certificates of Insurance certifying that Lessee has agreed to the below specified insurance with minimum coverage of:

Commercial General Liability with a limit of not less than \$1,000,000.00 each occurrence and \$2,000,000.00 in the annual aggregate. Policy shall cover liability for bodily injury, personal

injury, and property damage and products/completed operations arising out of the business operations of the policy holder.

Employers' Liability insurance with limits of not less than \$1,000,000.00 per injury by accident, \$1,000,000.00 per injury by disease, and \$1,000,000.00 per bodily injury by disease.

Workers' Compensation in accordance with the laws of the State of Texas. Substitutes to genuine Workers' Compensation Insurance will not be allowed.

Business Automobile Liability coverage applying to owned, non-owned and hired automobiles with limits not less than \$1,000,000.00 each occurrence combined single limit for Bodily Injury and Property Damage combined.

Lessee is responsible to maintain insurance on all personal property belonging to Lessee. Lessor and the members of the Fort Bend County Commissioners Court shall be named as additional insured to all required coverage except for Workers' Compensation. All liability policies written on behalf of Lessee shall contain a waiver of subrogation in favor of Lessor and members of the Fort Bend County Commissioners Court.

Except as to injury, death or property damage resulting from the negligence of Lessor, Lessor's agents, employees or contractors, Lessee agrees to indemnify and hold harmless Lessor and its representatives, successors and assigns from and against all claims, demands, rights, costs, expenses, compensation and causes of action of whatever kind and nature, including bodily and personal injuries, damage to property and the consequences thereof, resulting from the use, installation, removal, maintenance or repair of Lessee's equipment or Lessee's employees, officers, directors, agents, owners, representatives, contractors, guest, invitees, workers, employees, successors and assigns. Lessee hereby acknowledges and agrees that Lessee's use of the site is at Lessee's own risk, and Lessee hereby releases Lessor, Lessor's agents, employees and contractors from all claims except for any damage or injury resulting from the negligence or intentional wrongful conduct of Lessor, Lessor's agents, employees or contractors.

## **15. HAZARDOUS MATERIALS**

Lessee represents to Lessor, as part of the consideration recited herein that no part of the Leased Premises shall be used by Lessee for disposal, storage, treatment, processing, manufacturing or other handling of any hazardous wastes, hazardous substances, asbestos or other materials (collectively, the foregoing are referred to herein as "Hazardous Materials")

deemed hazardous or otherwise subject to any federal, state, county or municipal laws, statutes, codes, rules, regulations or ordinances pertaining to the use, handling, release, disposal, storage, treatment, processing or manufacturing of such Hazardous Materials or similar materials and substances (collectively, all such laws, etc. are referred to herein as "Environmental Laws.")

Lessee expressly acknowledges and agrees that in the event of any such contamination by Hazardous Materials shall hereafter occur, or shall hereafter be determined to have occurred, arising out of or resulting from Lessee's occupancy, at, upon, or from the Leased Premises, Lessee hereby covenants and agrees, that Lessee shall clean-up, remove, resolve, minimize the impact of or otherwise to remediate (any and all such activities being referred to generally as "Remediation") any such contamination of the property to be in compliance with all Environmental Laws.

Lessee shall indemnify Lessor for, and shall defend and hold Lessor harmless from and against, any and all liabilities, causes of action, demands, penalties, losses, costs and expenses, including, but not limited to, attorney's fees and costs of Remediation, which may be suffered, paid or incurred by Lessor with respect to, or as a direct or indirect result of, the presence on or under, of the escape, seepage, leakage, spillage, discharge, emissions or release upon or from the Leased Premises of any Hazardous Materials or any contamination by Hazardous Materials, that may arise out off or result from the Lessee's use and occupancy of the Leased Premises. Notwithstanding anything as set forth to the contrary herein, it is Lessor's intention that Lessee shall have no liability or responsibility for damage or injury to human health, economic losses or damage to the environment or natural resources caused by, or otherwise relating to Hazardous Materials located on or at the Leased Premises which were not stored, used, generated, installed or disposed of by Lessee. The foregoing provision shall survive the expiration or earlier termination of the Lease

## **16. DEBT SECURITY**

Lessee may, without Lessor's consent, pledge, mortgage, convey by deed of trust or security deed, assign, create a security interest in, or otherwise execute and deliver any and all instruments for the purpose of securing a bona fide indebtedness, any or all of Lessee's interest in this Lease Agreement, any part thereof, and any and all of Lessee's right, title and interest in and to any and all of the Leased Premises. Promptly on Lessee's or Lessee's lender's request, Lessor shall execute and deliver all documents requested and prepared by any of Lessee's lenders including but not limited to waivers of Lessor's right to levy or distrain upon for rent of any of Lessee's property given as security for a debt, Lessor's estoppel certificate and agreement, consents to giving notice to Lessee's lender(s) in the event of Lessee's default under the provisions of this Lease Agreement, consents to Lessee's assignment to any lender(s) of any and

all of Lessee's interest in or to this Lease Agreement and the Leased Premises and nondisturbance agreements from Lessor.

**17.  
NOTICES**

All notices pertaining to this Lease Agreement shall be considered as duly delivered when mailed to the address hereafter specified by registered, certified or regular mail. All notices shall be considered as duly delivered when mailed to the addresses specified below as hereinafter indicated. Either party may from time to time designate a different address by written notice to the other party. The initial addresses to be utilized hereunder are as follows, to-wit:

Lessor: Fort Bend County  
Attn: County Judge  
301 Jackson  
Richmond, Texas 77471

Copy to: Fort Bend County Purchasing Agent  
301 Jackson  
Richmond, Texas 77469

Lessee: Clear Wireless LLC  
Sprint Property Services  
Mailstop KSOPHT0101-Z2650  
Site ID: HO52XC283  
6931 Sprint Parkway  
Overland Park, Kansas 66251-2650

Copy to: Sprint Law Department  
Attn: Real Estate Attorney  
Site ID: HO52XC283  
Mailstop KSOPHT0101-Z2020  
6931 Sprint Parkway  
Overland Park, Kansas 66251-2020

**18.  
INDEMNIFICATION**

Lessee shall indemnify and hold harmless Lessor from and against any and all claims, suits, causes of action and damages of any kind or nature, arising from, or relating to the use of the site by Lessee unless such claim or damage is the result of the act, omission or negligence of Lessor. IN NO EVENT WILL EITHER PARTY HERETO BE LIABLE FOR ANY LOSS OF USE, LOSS OF TIME, INCONVENIENCE, COMMERCIAL LOSS, LOST PROFITS OR SAVINGS

OR OTHER INCIDENTAL OR CONSEQUENTIAL DAMAGES TO THE FULLEST EXTENT SUCH MAY BE DISCLAIMED BY LAW.

**19.**  
**ENVIRONMENTAL**

To the best of Lessor's knowledge, the Lessor represents and warrants that the site has not been used for the generation, storage, treatment or disposal of hazardous substances or hazardous wastes. In addition, no hazardous substances, hazardous wastes, pollutants, asbestos, polychlorinated biphenyls (PCBs), petroleum or other fuels (including crude oil or any fraction or derivative thereof) or underground storage tanks (collectively "Environmental Hazards") are located on or about the site. For purposes of this Lease Agreement, the term "hazardous substances" shall be defined as in the Comprehensive Environmental Response, Compensation, and Liability Act (42 U.S.C. Section 9601 *et seq.*) (CERCLA), and any regulations promulgated pursuant thereto. The term "hazardous wastes" shall be as defined in the Resource Conservation and Recovery Act (42 U.S.C. Section 6901 *et seq.*) (RCRA), and any regulations promulgated pursuant thereto. The term "pollutants" shall be as defined in the Clean Water Act (33 U.S.C. Section 1251 *et seq.*), and any other regulations promulgated pursuant thereto. Lessee shall have the right and obligation during the option period to conduct such environmental tests as Lessee shall require to determine if Environmental Hazards exist on or about the site. Lessor shall have no obligation to conduct such test nor does Lessor have any obligation to indemnify and save harmless Lessee from and against any liabilities, penalties, fines, forfeitures, demands, damages, losses, claims, causes of action, suits, judgments, and costs and expenses, incidental thereto with any respect to any Environmental Hazards. In the event any Environmental Hazards are found during the option period, Lessee shall have the right to terminate such option and receive the monies deposited to Lessor. If any Environmental Hazards are found at any time during the Primary Term or any Renewal periods, other than any Environmental Hazards caused by Lessee's activities, Lessee shall have the right to terminate this Lease Agreement by so notifying Lessor in writing. Obligations of Lessee upon termination shall be the same as to Lessee's obligations as previously set out in this Lease Agreement.

**20.**  
**ESTOPPEL**

Lessee shall at any time upon fourteen (14) days prior written notice from Lessor execute, acknowledge and deliver to Lessor a statement in writing (a) certifying that this Lease Agreement is unmodified and in full force and effect (or, if modified, stating the nature of such modification), and the date to which the Rent and other charges are paid in advance, if any, (b) acknowledging that there are not, to Lessee's knowledge, any uncured defaults on the part of Lessor hereunder, or specifying such defaults if any are unclaimed, and (c) setting forth

any prepaid Rent. Any such statement may be conclusively relied upon by any prospective purchaser, investor, lessee or encumbrancer of the site.

**21.**  
**MISCELLANEOUS**

- (a) Lessor and Lessee represent and warrant to each other that no broker was involved in connection with this transaction.
- (b) This Lease Agreement shall be construed and governed by the laws of the State of Texas. The parties agree that venue for any action involving this Lease Agreement may only be brought in Fort Bend County.
- (c) This Lease Agreement may be amended only in writing, executed by both parties hereto or their permitted transferees.
- (d) This Lease Agreement, together with any exhibits attached hereto, shall constitute the entire agreement between the parties hereto. No party shall be bound by any communications between them on the subject matter of this Lease Agreement unless the communication is in writing, bears a date contemporaneous with or subsequent to the date of this Lease Agreement, and is agreed to by all parties hereto. Upon execution of this Lease Agreement, all prior agreements or understandings between the parties regarding the subject matter hereof shall be null and void.

In the event of one or more of the provisions contained in this Lease Agreement shall for any reason be held to be invalid, illegal or unenforceable in any respect, such invalidity, illegality, or unenforceability shall not affect any other provision hereof and this Lease Agreement shall be construed as if such invalid, illegal, or unenforceable provision had never been contained herein.

- (e) The headings of the paragraphs of this Lease Agreement are for the guidance and convenience of reference only and shall not otherwise affect any of the terms or provisions hereof.
- (f) This Lease Agreement may be executed in any number of counterparts, each of which shall be deemed an original instrument, and all of which together shall constitute one and the same instrument. This Lease Agreement shall become operative when each party has executed at least one counterpart.
- (g) This Lease Agreement contains the entire Agreement among the parties and supercedes all other negotiations and agreements, whether written or oral.

**22.**  
**EXECUTION**

**IN TESTIMONY OF WHICH, THIS LEASE AGREEMENT** has been executed by Lessor and Lessee as of the date below stated. Lessor and Lessee warrant and represents that the individual executing this Lease Agreement on behalf each have full authority to execute this Lease Agreement and bind each party to the same.

LESSOR:

**FORT BEND COUNTY**

By: \_\_\_\_\_

*Robert E. Hebert*  
Robert E. Hebert, County Judge

ATTEST:

Date: \_\_\_\_\_

12-19-2017

*Laura Richard*  
Laura Richard, County Clerk

APPROVED:

*James Knight*  
James Knight, Facilities Management/Planning Director

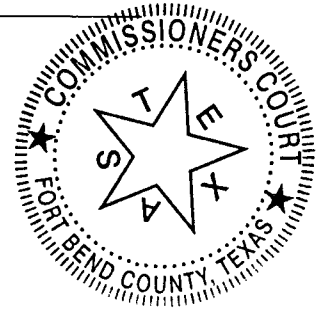

LESSEE:

**Clear Wireless LLC,**  
**a Nevada limited liability company**

By: \_\_\_\_\_

*Silvia J. Lin*  
Silvia J. Lin, Manager - Real Estate

Date: \_\_\_\_\_

12/11/2017

ATTEST:

*Michelle Crawford*

# EXHIBIT A

**BUILT AS PLANNED**

By CGrant at 8:57:06 AM, 1/16/2014

# CLEAR™

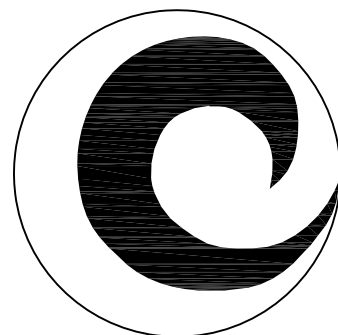

## TX-HOU0465T12.1

SITE ADDRESS

309 S. 4TH STREET  
RICHMOND, TX 77469

### APPROVAL

CLEAR WIRELESS PM SIGNATURE PHONE NUMBER DATE

CLEAR WIRELESS RF SIGNATURE PHONE NUMBER DATE

CLEAR WIRELESS CONSTRUCTION SIGNATURE PHONE NUMBER DATE

CLEAR WIRELESS BACKHUAL SIGNATURE PHONE NUMBER DATE

SITE AQISITION SIGNATURE PHONE NUMBER DATE

### DRAWING INDEX

### REV.

T-1	TITLE SHEET	1
A-1	COMPOUND PLAN	1
A-2	NORTH & EAST ELEVATIONS	1
A-3	DETAILS & NOTES	1

### DIRECTIONS:

FROM INTERSECTION BETWEEN I-610 SOUTH AND US-59 [SOUTHWEST FWY], DEPART FROM EXIT 8A ON I-610 (SOUTH) 0.1 MI US-59 / DOWNTOWN / VICTORIA, TAKE RAMP (RIGHT) ONTO US-59 [SOUTHWEST FWY] 21.9 MI US-59 / VICTORIA, KEEP RIGHT ONTO RAMP 0.4 MI FM-762 / RICHMOND, TURN RIGHT (NORTH-WEST) ONTO FM-762 [THOMPSON RD] 2.2 MI KEEP STRAIGHT ONTO FM-762 [S 11TH ST] 0.3 MI TURN RIGHT (EAST) ONTO US-90 ALT [JACKSON ST] 0.4 MI TURN RIGHT (SOUTH) ONTO S 4TH ST, THEN IMMEDIATELY TURN LEFT (EAST) ONTO LIBERTY ST 131 YDS ARRIVE 309 S. 4TH STREET, RICHMOND, TX 77469

### VICINITY MAP - 1"=2000'

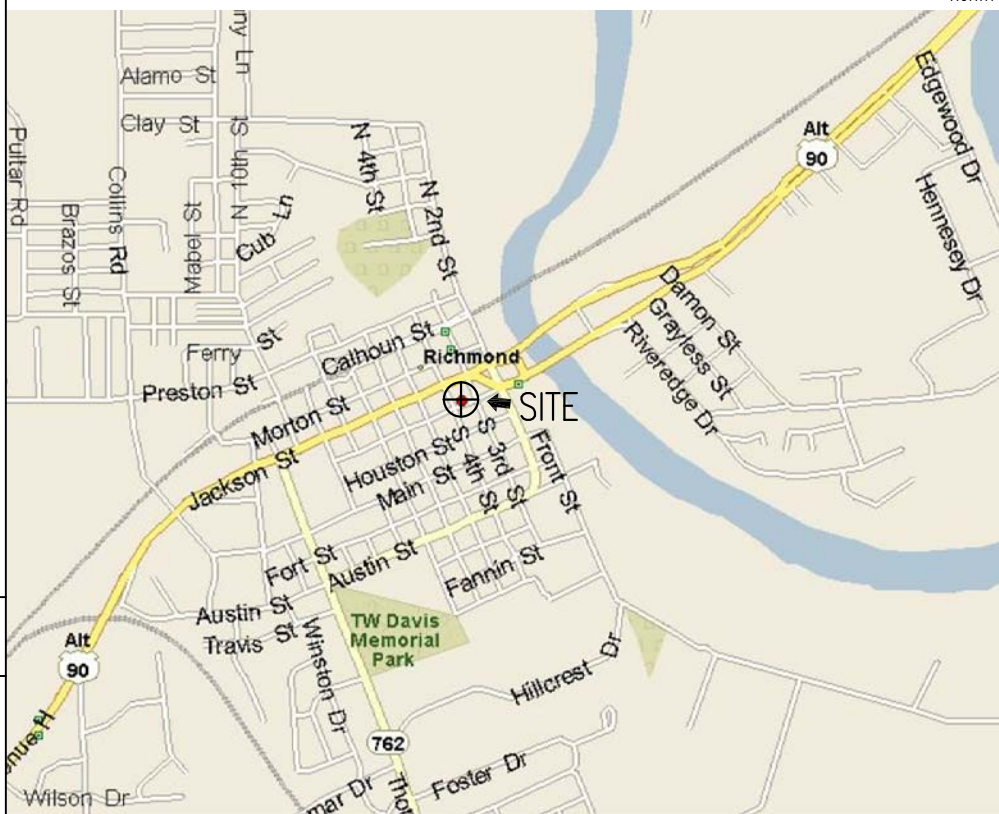

### NOTES:

#### CLEARWIRELESS CONSTRUCTION INSTALLATION GUIDE:

CONTRACTOR SHALL REFER TO "CLEAR WIRELESS CONSTRUCTION INSTALLATION GUIDE MANUAL, WIMAX VERSION 5.5, RELEASE DATE OCTOBER 9, 2009" WHICH GOVERNS THE CONDUCT OF THIS WORK AND ANY ITEMS OR DETAILS NOT LISTED OR DETAILED HEREIN. THE GUIDE SHALL SUPERSEDE WHERE CONFLICTS OCCUR. ALSO, CONTRACTOR IS TO INSURE THAT CONTRACTOR IS FULLY QUALIFIED, AUTHORIZED, LICENSED AND INSURED TO PERFORM THE WORK BY CLEAR WIRELESS, THE LOCAL GOVERNING JURISDICTION AND THE OWNER OF THE FACILITY WHERE THE WORK IS TO OCCUR, PRIOR TO BEGINNING THE WORK. CLEAR WIRELESS WILL NOT BE RESPONSIBLE FOR ANY IMPACT OF ANY DELAY FOR FAILURE OF CONTRACTOR TO BE SO QUALIFIED, ETC.

### PROJECT SUMMARY

- SCOPE OF WORK:
- DECOM 3 DAP HEADS, USE THE EXISTING QUADPOL ANTENNAS FOR THE 3 NEW SAMSUNG nRRHv2'S (REMOTE RADIO HEADS) TO BE INSTALLED 1 PER SECTOR.
  - EXISTING QUADPOL INSTALLED W/INTERNAL RET; INSTALL NEW RET CABLE FROM RRH TO QUADPOL. CUT THE EXISTING PWR AND FIBER AT THE ENDS OF THE CONDUIT AND LEAVE ALL THE MW CABLES ALONE ALONG WITH THE EXISTING CONDUIT.
  - RUN NEW PWR AND FIBER IN NEW 2" CONDUIT +/- 350' AND 70 SLEEPERS, (2) NEW 2" PENETRATIONS AT PENTHOUSE WALL REQUIRED. PENETRATIONS TO BE SEALED WITH 4" X 4" PORT PLATE W/ RUBBER GROMMET INSERT TO MATCH 2" CONDUIT OD. ALL PENETRATIONS ARE THEN TO BE SEALED WITH FIRE-PROOF SEALANT AT ALL EXTERIOR AND INTERIOR PENETRATION POINTS.
  - ADD 3 NEW SPOOLBOXES AT FOR THE NEW CABLES.

SITE NUMBER: TX-HOU0465T12.1  
 SITE ADDRESS: 309 S. 4TH STREET RICHMOND, TX 77469  
 ID #: 7395-00-098-0050-901  
 PROPERTY OWNER: FORT BEND COUNTY  
 APPLICANT: CLEAR WIRELESS, LLC 1475 120TH AVE., NE BELLEVUE, WA 98005  
 CONTACT: CHARITY GROOMS (842) 933-9696 9801 HIGGINS RD. ROSEMONT, IL 60018  
 LATITUDE: 29° 34' 54.394" N  
 LONGITUDE: 95° 45' 39.139" W  
 ELEVATION: 92± AMSL  
 COUNTY: FORT BEND  
 JURISDICTION: FORT BEND COUNTY

CODE:  
 CLEAR WIRELESS & ANTENNA ARRAYS HAVE BEEN DESIGNED AND SHALL BE CONSTRUCTED IN ACCORDANCE WITH THE FOLLOWING APPLICABLE BUILDING CODES:  
 NATIONAL ELECTRICAL CODE (NEC) 2008 EDITION  
 INTERNATIONAL BUILDING CODE (IBC) 2003 EDITION

CALL TEXAS ONE CALL SYSTEM (TOCS)  
 ☎ 1-(800) 245-4545, 48 HOURS BEFORE DIGGING, NOT INCLUDING WEEKENDS AND HOLIDAYS

#### ARCHITECT AND ELECTRICAL ENGINEER:

BC ARCHITECTS ENGINEERS, PLC  
5661 COLUMBIA PIKE, SUITE 200  
FALLS CHURCH, VA 22041  
TEL: (703) 671-6000 CONTACT: CHRIS MORIN  
FAX: (703) 671-6300

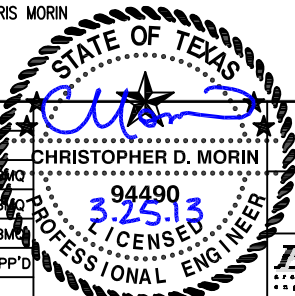

5661 COLUMBIA PIKE, SUITE 200  
FALLS CHURCH, VA 22041-2868  
TEL: (703) 671-6000  
FAX: (703) 671-6300

### TX-HOU0465T12.1

309 S. 4TH STREET  
RICHMOND, TX 77469



1475 120TH AVE., NE  
BELLEVUE, WA 98005

3						
2						
1	03-25-13	REVISED FINAL CONSTRUCTION DRAWINGS	SB	CDM	EMC	
0	03-04-13	FINAL CONSTRUCTION DRAWINGS	SB	CDM	EMC	
C	1-22-13	PRELIMINARY CONSTRUCTION DRAWINGS	AGT	CDM	EMC	
NO.	DATE	REVISIONS	BY	CHK	APP'D	
SCALE: AS SHOWN			DESIGNED	C. MORIN	DRAWN	SB

BC ARCHITECTS ENGINEERS  
FALLS CHURCH, VA

TITLE SHEET

DRAWING NUMBER	REV
T-1	1

Y:/Drawings - 2013/Clearwire/Augment/Houston/TX-HOU0465T12.1/CDS - Rev 1 - 03-25-13/T1.dwg 16:16:01 SBAGHER



Y:/Drawings - 2013/Clearwire/Augment/Houston/TX-HOU0465T12.1/CD'S/A2.dwg 10:34:41 ARNOLD 01-22-13

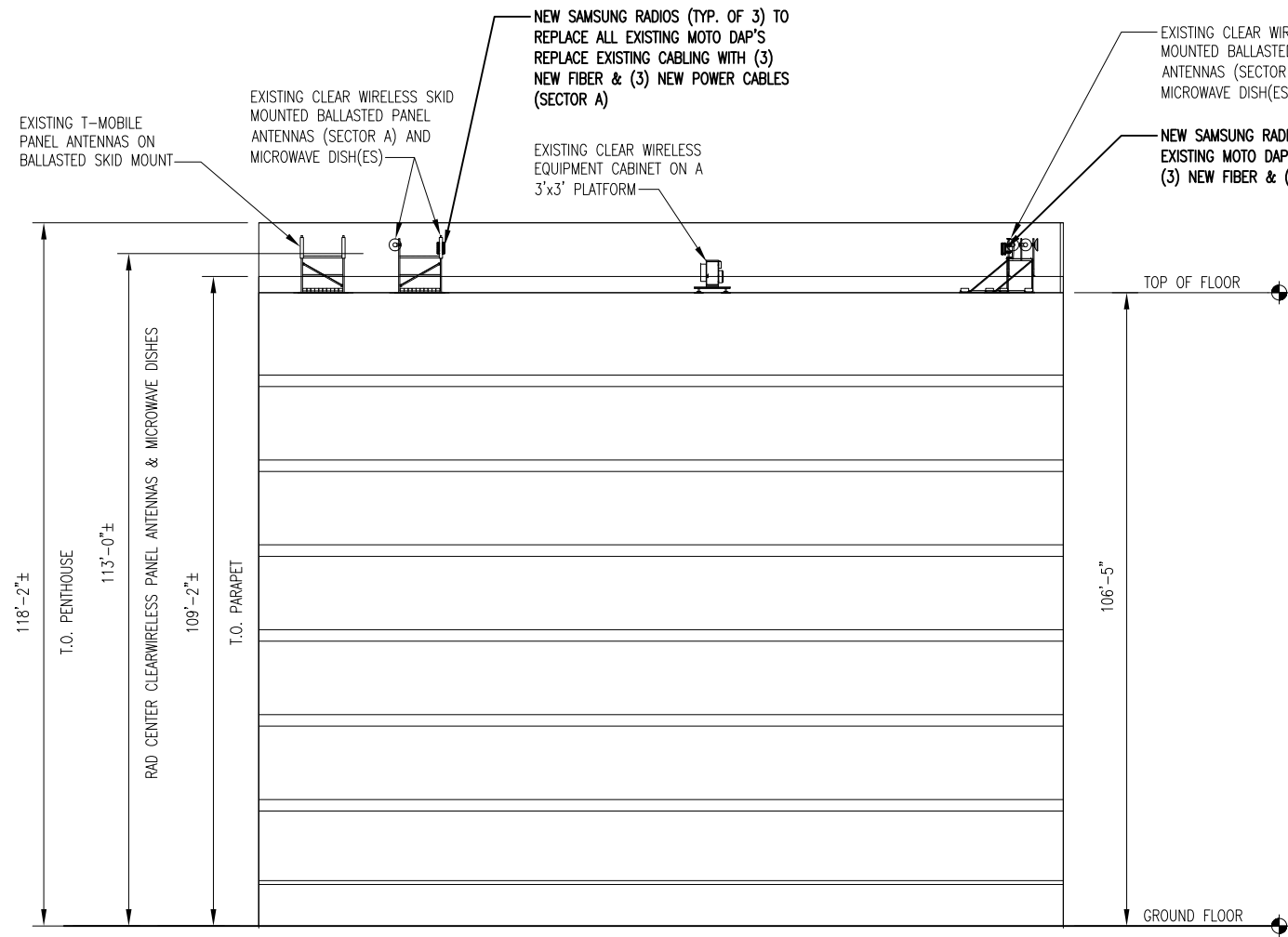

**NORTH ELEVATION**  
SCALE: 1"=30'

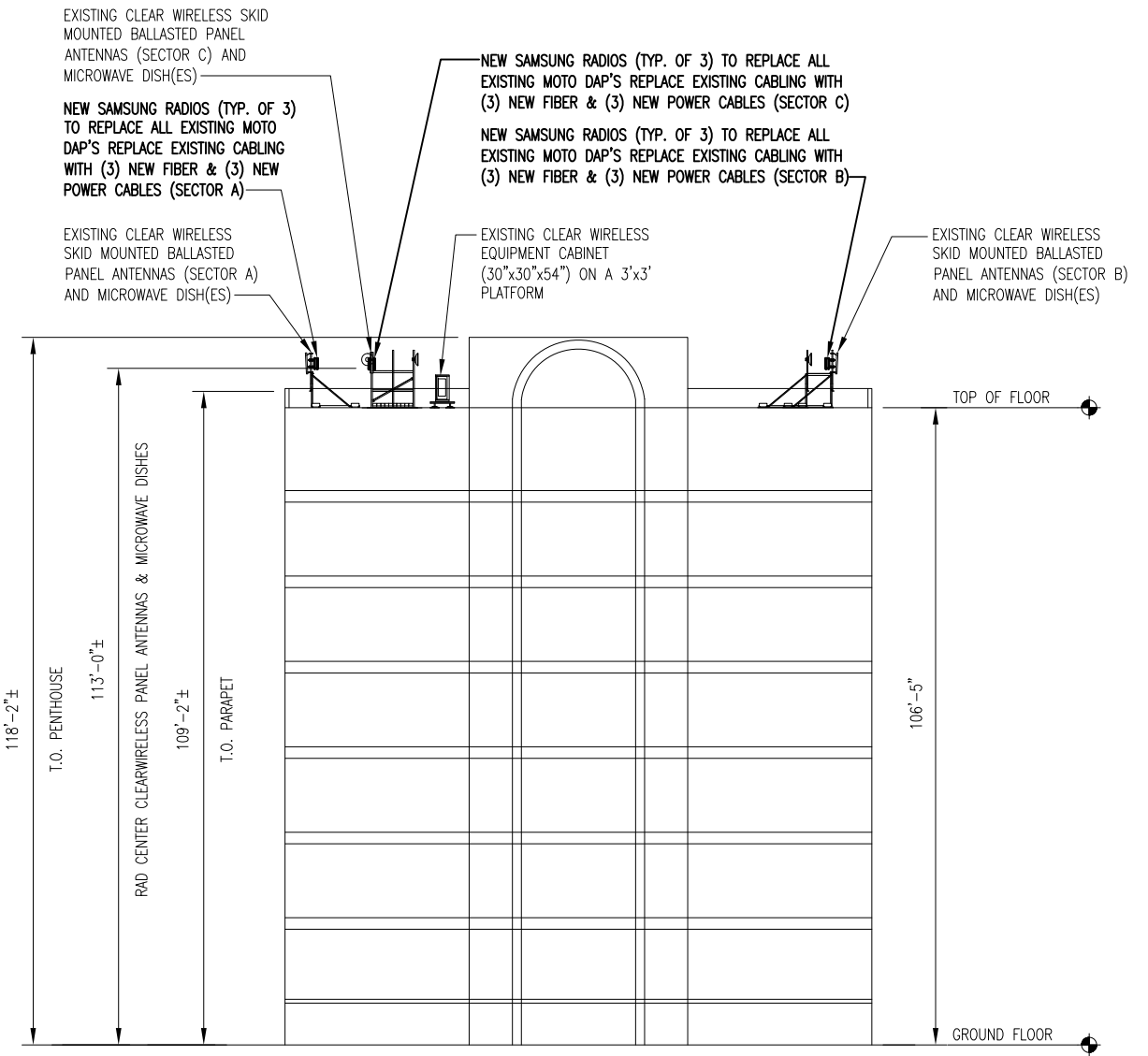

**EAST ELEVATION**  
SCALE: 1"=30'

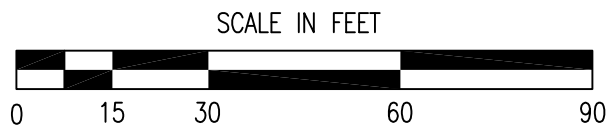

5661 COLUMBIA PIKE, SUITE 200  
FALLS CHURCH, VA 22041-2868  
TEL: (703) 671-8000  
FAX: (703) 671-6300

**TX-HOU0465T12.1**  
309 S. 4TH STREET  
RICHMOND, TX 77469



3					
2					
1	03-25-13	REVISED FINAL CONSTRUCTION DRAWINGS	SB	CDM	BMC
0	03-04-13	FINAL CONSTRUCTION DRAWINGS	SB	CDM	BMC
C	1-22-13	PRELIMINARY CONSTRUCTION DRAWINGS	AGT	CDM	BMC
NO.	DATE	REVISIONS	BY	CHK	APP'D
SCALE: AS SHOWN		DESIGNED C. MORIN	DRAWN SB		

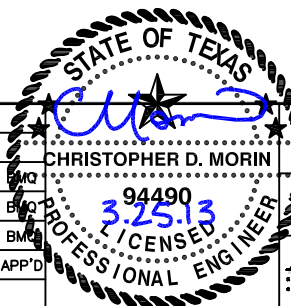

BC ARCHITECTS ENGINEERS  
FALLS CHURCH, VA  
NORTH & EAST ELEVATIONS

DRAWING NUMBER	REV
A-2	1

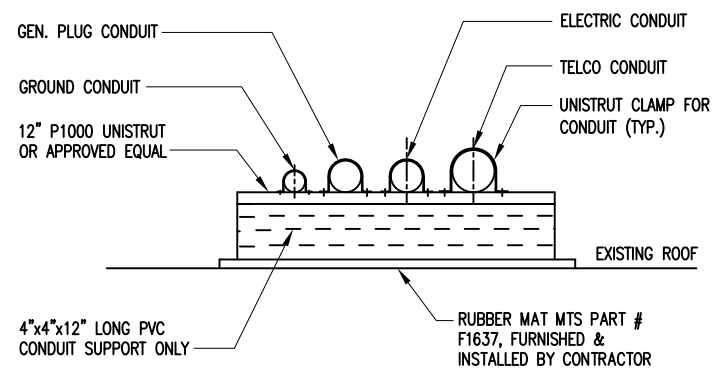

NOTE:  
MAX SPACING 6'-0" BETWEEN SUPPORTS

TYPICAL CONDUIT SUPPORT @ ROOF 1  
A-3  
SCALE: N.T.S.

TUBE ENTRY KIT MICROFLECT #B101 FOR UTILITY CONDUIT WALL PENETRATION, G.C. TO DRILL AND SEAL, USE FILL ANNULAR SPACE BETWEEN CABLE AND RGS PIPE WITH G.E. SILICONE RTV 6428. SEAL AND PACK WITH RTV 6428, FLUSH WITH BOTH SIDES

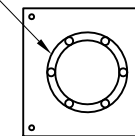

CONDUIT WALL PENETRATION DETAIL 2  
A-3  
N.T.S.

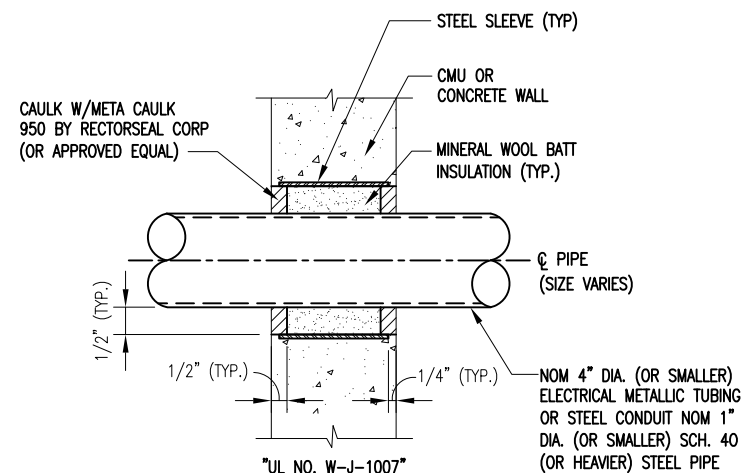

NOTE:  
CONDUIT ANCHORAGE IS REQUIRED NEARBY TO PREVENT PIPE MOVEMENT THRU PENETRATION

CONDUIT WALL PENETRATION DETAIL 3  
A-3  
N.T.S.

01-23-13 CHRIS MORIN 20:04:09 Y:/Drawings - 2013/Clearwire/Augment/Houston/TX-HOU0465T12.1/CD'S/A3.dwg

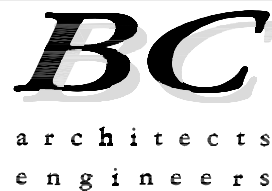

5661 COLUMBIA PIKE, SUITE 200  
FALLS CHURCH, VA 22041-2868  
TEL: (703) 671-8000  
FAX: (703) 671-6300

TX-HOU0465T12.1  
309 S. 4TH STREET  
RICHMOND, TX 77469



3					
2					
1	03-25-13	REVISED FINAL CONSTRUCTION DRAWINGS	SB	CDM	BMC
0	03-04-13	FINAL CONSTRUCTION DRAWINGS	SB	CDM	BMC
C	1-22-13	PRELIMINARY CONSTRUCTION DRAWINGS	AGT	CDM	BMC
NO.	DATE	REVISIONS	BY	CHK	APP'D
SCALE: AS SHOWN		DESIGNED C. MORIN	DRAWN SB		

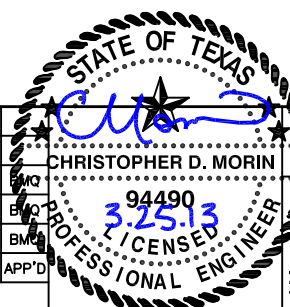

BC ARCHITECTS ENGINEERS  
FALLS CHURCH, VA

CONDUIT PENETRATION DETAILS  
AND NOTES



DRAWING NUMBER  
A-3

REV  
1

# CERTIFICATE OF INTERESTED PARTIES

FORM 1295

1 of 1

Complete Nos. 1 - 4 and 6 if there are interested parties.  
Complete Nos. 1, 2, 3, 5, and 6 if there are no interested parties.

## OFFICE USE ONLY CERTIFICATION OF FILING

Certificate Number:  
2017-293304

Date Filed:  
12/12/2017

Date Acknowledged:

**1 Name of business entity filing form, and the city, state and country of the business entity's place of business.**

Clear Wireless LLC  
Overland Park, KS United States

**2 Name of governmental entity or state agency that is a party to the contract for which the form is being filed.**

Fort Bend County

**3 Provide the identification number used by the governmental entity or state agency to track or identify the contract, and provide a description of the services, goods, or other property to be provided under the contract.**

RFP 17-043  
Lease of Roof Space for Cellular Telephone Antenna

4	Name of Interested Party	City, State, Country (place of business)	Nature of interest (check applicable)	
			Controlling	Intermediary
	Clearwire Communications LLC	Overland Park, KS United States	X	

5 Check only if there is NO Interested Party.

**6 AFFIDAVIT**

I swear, or affirm, under penalty of perjury, that the above disclosure is true and correct.

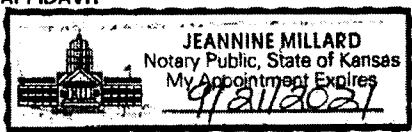

Silvia J. Lin  
Signature of authorized agent of contracting business entity

AFFIX NOTARY STAMP / SEAL ABOVE

Sworn to and subscribed before me, by the said Silvia J. Lin, this the 12<sup>th</sup> day of December 2017 to certify which, witness my hand and seal of office.

Jeannine Millard Signature of officer administering oath  
Jeannine Millard Printed name of officer administering oath  
RE Manager Title of officer administering oath

# CERTIFICATE OF INTERESTED PARTIES

FORM 1295

1 of 1

Complete Nos. 1 - 4 and 6 if there are interested parties.  
Complete Nos. 1, 2, 3, 5, and 6 if there are no interested parties.

## OFFICE USE ONLY CERTIFICATION OF FILING

**1 Name of business entity filing form, and the city, state and country of the business entity's place of business.**  
Clear Wireless LLC  
Overland Park, KS United States

**Certificate Number:**  
2017-293304

**Date Filed:**  
12/12/2017

**2 Name of governmental entity or state agency that is a party to the contract for which the form is being filed.**  
Fort Bend County

**Date Acknowledged:**  
12/19/2017

**3 Provide the identification number used by the governmental entity or state agency to track or identify the contract, and provide a description of the services, goods, or other property to be provided under the contract.**  
RFP 17-043  
Lease of Roof Space for Cellular Telephone Antenna

4	Name of Interested Party	City, State, Country (place of business)	Nature of interest (check applicable)	
			Controlling	Intermediary
	Clearwire Communications LLC	Overland Park, KS United States	X	

**5 Check only if there is NO Interested Party.**

**6 AFFIDAVIT** I swear, or affirm, under penalty of perjury, that the above disclosure is true and correct.

\_\_\_\_\_  
Signature of authorized agent of contracting business entity

AFFIX NOTARY STAMP / SEAL ABOVE

Sworn to and subscribed before me, by the said \_\_\_\_\_, this the \_\_\_\_\_ day of \_\_\_\_\_, 20\_\_\_\_\_, to certify which, witness my hand and seal of office.

\_\_\_\_\_  
Signature of officer administering oath      Printed name of officer administering oath      Title of officer administering oath