

**Fort Bend County Tabulation
Bid 16-071
Helicopter Navigation System**

**Recommendation: Churchill Navigation, Inc.
Funding: OEM Grant for Sheriff's Office**

price per each

Description	Churchill Navigation Boulder CO
Churchill navigation augmented reality mapping system for use with FLIR 8500 sensor, full version ARS systems with overlay over video and camera steering, #ARC-600C Quantity: 1 each	\$115,000.00
Internal navigation system, Honeywell IMU, GNSS, #NOV-INS Quantity: 1 each	\$25,000.00
Analog to HD/SD-SDI convertor, #AJA-CONV-D Quantity: 1 each	\$900.00
Serial bypass switch and cable, #ARS-SERBY Quantity: 1 each	included
NVIS keyboard, rack mount, #ARS-KB-R Quantity: 1 each	\$2,000.00
GNSS antenna, external, #NOV-PRO-ANT Quantity: 1 each	\$675.00
Grand Total	\$143,575.00
Form 1295	Yes

Fort Bend County Specification Download Acknowledgment

**Invitation for Bid
Helicopter Navigation System
for Fort Bend County Sheriff's Office
BID 16-071**

VENDORS MUST IMMEDIATELY RETURN THIS FORM BY FAX TO 281-344-8645.

Vendor Responsibilities:

- Vendors are responsible to download and complete any addendums.
(Addendums will be posted on the Fort Bend County Website no later than 48 hours prior to Bid Opening)
- Vendors will submit responses in accordance with requirements stated on cover of document.
- Vendors may not submit responses via email or fax.

Churchill Navigation, Inc.

Legal Name of Contracting Company

Erin Murphy

Contact Person

5660 Airport Blvd. Boulder, Co 80301

Complete Mailing Address

(720)744-3300

Telephone Number

n/a

Facsimile Number

erin@churchillnavigation.com

Email Address

Signature

Date

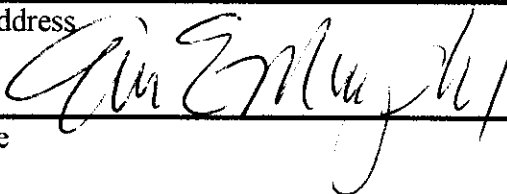

3/16/2014

saltam ✓

**Fort Bend County, Texas
Invitation for Bid**

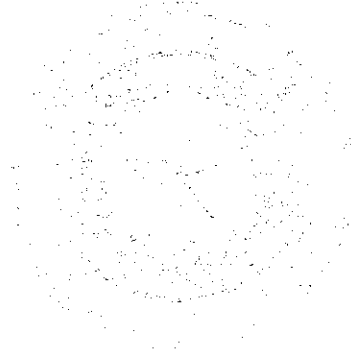

**Helicopter Navigation System
for Fort Bend County Sheriff's Office
BID 16-071**

SUBMIT BIDS TO:

**Fort Bend County
Purchasing Department
Travis Annex
301 Jackson, Suite 201
Richmond, TX 77469**

****NOTE:**

All correspondence must include the term "Purchasing Department" in address to assist in proper delivery.

SUBMIT NO LATER THAN:

**Thursday, March 31, 2016
1:30 PM (Central)**

LABEL ENVELOPE:

**BID 16-071
Navigation System**

*ALL BIDS MUST BE RECEIVED AND COMPLETELY SEALED BY THE PURCHASING OFFICE
OF FORT BEND COUNTY BEFORE THE SPECIFIED TIME DATE STATED ABOVE.*

BIDS RECEIVED AS REQUIRED WILL THEN BE OPENED AND PUBLICLY READ.

BIDS RECEIVED AFTER THE SPECIFIED TIME WILL BE RETURNED UNOPENED.

**Results will not be given by phone.
Results will be provided to bidder
in writing after the Commissioners
Court awards.**

**Fort Bend County is always conscious and
extremely appreciative of your effort in
the preparation of this bid.**

**Requests for information must be in writing
and directed to:**

**Debbie Kaminski, CPPB
Assistant Purchasing Agent
Debbie.Kaminski@fortbendcountytexas.gov**

**Prepared: 3/10/16
Issued: 3/16/16**

Vendor Information

Churchill Navigation Inc.
Legal Name of Contracting Company

Federal ID Number (Company or Corporation) or Social Security Number (Individual)

(720) 744-3300 Telephone Number n/a Facsimile Number

5660 Airport Blvd .
Complete Mailing Address (for Correspondence)

Boulder, CO 80301
City, State and Zip Code

Complete Remittance Address (if different from above)

City, State and Zip Code

Erin E. Murphy, Director of Sales
Authorized Representative and Title (printed)

erin@churchillnavigation.com
Authorized Representative's Email Address

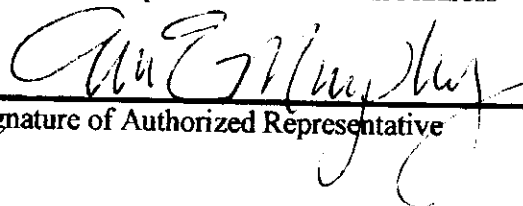
 Signature of Authorized Representative
3/25/2016 Date

1.0 GENERAL REQUIREMENTS:

- 1.1 Read this entire bid document carefully. Follow all instructions. You are responsible for fulfilling all requirements and specifications. Be sure you understand them.
- 1.2 General Requirements apply to all advertised bids; however, these may be superseded, whole or in part, by the scope, special requirements, specifications, special specifications or other data contained herein.
- 1.3 Governing Law: Bidder is advised that these requirements shall be fully governed by the laws of the State of Texas and that Fort Bend County may request and rely on advice, decisions and opinions of the Attorney General of Texas and the County Attorney concerning any portion of these requirements.
- 1.4 Bid Document Completion: Fill out, initial each page, sign, and return ONE (1) complete bid document to the Fort Bend County Purchasing Department. An authorized representative of the bidder must sign the Contract Sheet. The contract will be binding only when signed by the County Judge, Fort Bend County and a purchase order authorizing the item(s) desired has been issued. The use of liquid paper is not acceptable and may result in the disqualification of bid. If an error is made, vendor must draw a line through error and initial each change. All response, typed or written, information must be clear and legible.
- 1.5 Bid Returns: Bidders must return entire completed bid document to the Fort Bend County Purchasing Department at 301 Jackson, Suite 201, Richmond, Texas no later than 1:30 P.M. on the date specified. Late bids will not be accepted. Bids must be submitted in a sealed envelope, addressed as follows: Fort Bend County Purchasing Agent, Travis Annex, 301 Jackson, Suite 201, Richmond, Texas 77469.
- 1.6 Governing Document: In the event of any conflict between the terms and provisions of these requirements and the specifications, the specifications shall govern. In the event of any conflict of interpretation of any part of this overall document, Fort Bend County's interpretation shall govern.
- 1.7 Addendums: No interpretation of the meaning of the drawings, specifications or other bid documents will be made to any bidder orally. All requests for such interpretations must be made in writing addressed to Ms. Debbie Kaminski, Assistant Purchasing Agent, 301 Jackson, Suite 201, Richmond, Texas 77469, e-mail: Debbie.Kaminski@fortbendcountytexas.gov. Any and all interpretations and any supplemental instructions will be in the form of written addenda to the contract documents which will be posted on Fort Bend County's website. Addenda will **ONLY** be issued by the Fort Bend County Purchasing Agent. It is the sole responsibility of each bidder to insure receipt of any and all addenda. All addendum issued will become part of the contract documents. Bidders must sign

Initials of Bidder: QM

and include addendum in the returned bid package. Deadline for submission of questions and/or clarification is **Thursday, March 24, 2016 at 10:00 a.m. (CST)**. Requests received after the deadline will not be responded to due to the time constraints of this bid process.

- 1.8 **Hold Harmless Agreement:** Contractor shall indemnify and hold Fort Bend County harmless from all claims for personal injury, death and/or property damage arising from any cause whatsoever, resulting directly or indirectly from contractor's performance. Contractor shall procure and maintain, with respect to the subject matter of this bid, appropriate insurance coverage including, as a minimum, public liability and property damage with adequate limits to cover contractor's liability as may arise directly or indirectly from work performed under terms of this bid. Certification of such coverage must be provided to the County upon request.
- 1.9 **Waiver of Subrogation:** Bidder and bidder's insurance carrier waive any and all rights whatsoever with regard to subrogation against Fort Bend County as an indirect party to any suit arising out of personal or property damages resulting from bidder's performance under this agreement.
- 1.10 **Severability:** If any section, subsection, paragraph, sentence, clause, phrase or word of these requirements or the specifications shall be held invalid, such holding shall not affect the remaining portions of these requirements and the specifications and it is hereby declared that such remaining portions would have been included in these requirements and the specifications as though the invalid portion had been omitted.
- 1.11 **Bonds:** If this bid requires submission of bid guarantee and performance bond, there will be a separate page explaining those requirements. Bids submitted without the required bid bond or cashier's checks are not acceptable. Bond/s or cashier's check must be complete with all required signatures.
- 1.12 **Taxes:** Fort Bend County is exempt from all federal excise, state and local taxes unless otherwise stated in this document. Fort Bend County claims exemption from all sales and/or use taxes under Chapter 20, Title 122a, Vernon's Texas Civil Statutes, as amended. Texas Limited Sales Tax Exemption Certificates will be furnished upon written request to the Fort Bend County Purchasing Department.
- 1.13 **Fiscal Funding:** A multi-year lease or lease/purchase arrangement (if requested by the specifications), or any contract continuing as a result of an extension option, must include fiscal funding out. If, for any reason, funds are not appropriated to continue the lease or contract, said lease or contract shall become null and void. After expiration of the lease, leased equipment shall be removed by the bidder from the using department without penalty of any kind or form to Fort Bend County. All charges and physical activity related to delivery, installation, removal and redelivery shall be the responsibility of the bidder.

Initials of Bidder: 

- 1.14 Pricing: Prices for all goods and/or services shall be firm for the duration of this contract and shall be stated in the bid spreadsheet. Prices shall be all inclusive. No price changes, additions, or subsequent qualifications will be honored during the course of the contract. All prices must be written in ink or typewritten. Pricing on all transportation, freight, and other charges are to be prepaid by the contractor and included in the bid prices. If there are any additional charges of any kind, other than those mentioned above, specified or unspecified, bidder MUST indicate the items required and attendant costs or forfeit the right to payment for such items.
- 1.15 Silence of Specifications: The apparent silence of specifications as to any detail, or the apparent omission from it of a detailed description concerning any point, shall be regarded as meaning that only the best commercial practice is to prevail and that only material and workmanship of the finest quality are to be used. All interpretations of specifications shall be made on the basis of this statement. The items furnished under this contract shall be new, unused of the latest product in production to commercial trade and shall be of the highest quality as to materials used and workmanship. Manufacturer furnishing these items shall be experienced in design and construction of such items and shall be an established supplier of the item bid.
- 1.16 Supplemental Materials: Bidders are responsible for including all pertinent product data in the returned bid package. Literature, brochures, data sheets, specification information, completed forms requested as part of the bid package and any other facts which may affect the evaluation and subsequent contract award should be included. Materials such as legal documents and contractual agreements, which the bidder wishes to include as a condition of the bid, must also be in the returned bid package. Failure to include all necessary and proper supplemental materials may be cause to reject the entire bid.
- 1.17 Material Safety Data Sheets: Under the "Hazardous Communication Act", commonly known as the "Texas Right To Know Act", a bidder must provide to County and using departments, with each delivery, material safety data sheets, which are, applicable to hazardous substances defined in the Act. Bidders are obligated to maintain a current, updated file in the Fort Bend County Purchasing Department. Failure of the bidder to maintain such a file will be cause to reject any bid applying thereto.
- 1.18 Name Brands: Specifications may reference name brands and model numbers. It is not the intent of Fort Bend County to restrict these bids in such cases, but to establish a desired quality level of merchandise or to meet a pre-established standard due to like existing items. Bidders may offer items of equal stature and the burden of proof of such stature rests with them. Fort Bend County shall act as sole judge in determining equality and acceptability of products offered.

Initials of Bidder gm

- 1.19 Color Selection: Determination of colors of materials is a right reserved by the using department unless otherwise specified in the bid. Unspecified colors shall be quoted as standard colors, not colors, which require up charges or special handling. Unspecified fabrics or vinyl should be construed as medium grade. If bidder fails to get color/material approvals prior to delivery of merchandise, the using department may refuse to accept the items and demand correct shipment without penalty, subject to other legal remedies.
- 1.20 Evaluation: Evaluation shall be used as a determinant as to which bid items or services are the most efficient and/or most economical for the County. It shall be based on all factors, which have a bearing on price and performance of the items in the user environment. All bids are subject to tabulation by the Fort Bend County Purchasing Department and recommendation to Fort Bend County Commissioners Court. Compliance with all bid requirements, delivery and needs of the using department are considerations in evaluating bids. Pricing is NOT the only criteria for making a recommendation. The Fort Bend County Purchasing Department reserves the right to contact any bidder, at any time, to clarify, verify or request information with regard to any bid.
- 1.21 Inspections: Fort Bend County reserves the right to inspect any item(s) or service location for compliance with specifications and requirements and needs of the using department. If a bidder cannot furnish a sample of a bid item, where applicable, for review, or fails to satisfactorily show an ability to perform, the County can reject the bid as inadequate.
- 1.22 Testing: Fort Bend County reserves the right to test equipment, supplies, material and goods bid for quality, compliance with specifications and ability to meet the needs of the user. Demonstration units must be available for review. Should the goods or services fail to meet requirements and/or be unavailable for evaluation, the bid is subject to rejection.
- 1.23 Disqualification of Bidder: Upon signing this bid document, a bidder offering to sell supplies, materials, services, or equipment to Fort Bend County certifies that the bidder has not violated the antitrust laws of this state codified in section 15.01, et seq., Business & Commerce Code, or the federal antitrust laws, and has not communicated directly or indirectly the bid made to any competitor or any other person engaged in such line of business. Any or all bids may be rejected if the County believes that collusion exists among the bidders. Bids in which the prices are obviously unbalanced may be rejected. If multiple bids are submitted by a bidder and after the bids are opened, one of the bids is withdrawn, the result will be that all of the bids submitted by that bidder will be withdrawn; however, nothing herein prohibits a vendor from submitting multiple bids for different products or services.
- 1.24 Awards: Fort Bend County reserves the right to award this contract on the basis of lowest and best bid in accordance with the laws of the State of Texas, to waive

any formality or irregularity, to make awards to more than one bidder, to reject any or all bids. In the event the lowest dollar bidder meeting specifications is not awarded a contract, the bidder may appear before the Commissioners Court and present evidence concerning his responsibility. An award is final only upon formal execution by the Fort Bend County Commissioners Court or the Fort Bend County Purchasing Agent. Fort Bend County reserves the right to withdraw any award until execution by the proper authority.

- 1.25 Assignment: The successful vendor may not assign, sell or otherwise transfer this contract without written permission of Fort Bend County Commissioners Court.
- 1.26 Term Contracts: If the contract is intended to cover a specific time period, said time will be given in the specifications under scope.
- 1.27 Maintenance: Maintenance required for equipment bid should be available in Fort Bend County by a manufacturer authorized maintenance facility. Costs for this service shall be shown on the bid sheet as requested or on a separate sheet, as required. If Fort Bend County opts to include maintenance, it shall be so stated in the purchase order and said cost will be included. Service will commence only upon expiration of applicable warranties and should be priced accordingly.
- 1.28 Contract Obligation: Fort Bend County Commissioners Court must award the contract and the County Judge or other person authorized by the Fort Bend County Commissioners Court must sign the contract before it becomes binding on Fort Bend County or the bidders. Department heads are not authorized to sign agreements for Fort Bend County. Binding agreements shall remain in effect until all products and/or services covered by this purchase have been satisfactorily delivered and accepted.
- 1.29 Title Transfer: Title and Risk of Loss of goods shall not pass to Fort Bend County until Fort Bend County actually receives and takes possession of the goods at the point or points of delivery. Receiving times may vary with the using department. Generally, deliveries may be made between 8:30 a.m. and 4:00 p.m., Monday through Friday. Bidders are advised to consult the using department for instructions. The place of delivery shall be shown under the "Special Requirement" section of this bid document and/or on the Purchase Order as a "Ship To:" address.
- 1.30 Purchase Order and Delivery: The successful bidder shall not deliver products or provide services without a Fort Bend County Purchase Order, signed by an authorized agent of the Fort Bend County Purchasing Department. The fastest, most reasonable delivery time shall be indicated by the bidder in the proper place on the bid sheet. Any special information concerning delivery should also be included, on a separate sheet, if necessary. All items shall be shipped F.O.B. inside delivery unless otherwise stated in the specifications. This shall be understood to include bringing merchandise to the appropriate room or place

designated by the using department. Every tender or delivery of goods must fully comply with all provisions of these requirements and the specifications including time, delivery and quality. Nonconformance shall constitute a breach, which must be rectified prior to expiration of the time for performance. Failure to rectify within the performance period will be considered cause to reject future deliveries and cancellation of the contract by Fort Bend County without prejudice to other remedies provided by law. Where delivery times are critical, Fort Bend County reserves the right to award accordingly.

- 1.31 Contract Extension: Extensions may be made only by written agreement between Fort Bend County and the bidder. Any price escalations are limited to those stated by the bidder in the original bid.
- 1.32 Termination: Fort Bend County reserves the right to terminate the contract for default if Seller breaches any of the terms therein, including warranties of bidder or if the bidder becomes insolvent or commits acts of bankruptcy. Such right of termination is in addition to and not in lieu of any other remedies, which Fort Bend County may have in law or equity. Default may be construed as, but not limited to, failure to deliver the proper goods and/or services within the proper amount of time, and/or to properly perform any and all services required to Fort Bend County's satisfaction and/or to meet all other obligations and requirements. Contracts may be terminated without cause upon thirty (30) days written notice to either party unless otherwise specified.
- 1.33 Recycled Materials: Fort Bend County encourages the use of products made of recycled materials and shall give preference in purchasing to products made of recycled materials if the products meet applicable specifications as to quantity and quality. Fort Bend County will be the sole judge in determining product preference application.
- 1.34 Interlocal Participation: Additional governmental entities may purchase from this bid. Vendor agrees to accept purchase orders from those participating entities and to invoice each entity separately.
- 1.35 Escalation Clause: Successful bidder may apply for a price increase to the Fort Bend County Commissioners Court. Price increase will be the amount increased to the vendor from his supplier. Written documentation of the increase must be provided to the Purchasing Agent. No application for a price increase may be submitted within the first four (4) months of this contract. Increases of more than 25% of the original bid price will not be considered.

2.0 TERMS & CONDITIONS:

- 2.1 Seller to Package Goods: Seller will package goods in accordance with good commercial practice. Each delivery container shall be clearly and permanently marked as follows (a) Seller's name and address; (b) Consignee's name, address

Initials of Bidder: gml

and purchase order number and the bid number if applicable; (c) Container number and total number of containers (e.g. box 1 of 4 boxes); and (d) the number of the container bearing the packing slip. Seller shall bear cost of packaging unless otherwise provided. Goods shall be suitably packed to secure lowest transportation costs and to conform to requirements of common carriers and any applicable specifications. Fort Bend County's count or weight shall be final and conclusive on shipments not accompanied by packing list.

- 2.2 Shipment Under Reservation Prohibited: Seller is not authorized to ship goods under reservation and no tender of a bill of lading will operate as a tender of goods.
- 2.3 Title and Risk of Loss: The title and risk of loss of the goods shall not pass to the County until a County employee actually receives and takes possession of the goods at the point or points of delivery.
- 2.4 Delivery Terms: F.O.B. Destination Freight Prepaid, Inside Delivery, unless delivery terms are specified otherwise on Purchase Order.
- 2.5 No Replacement of Defective Tender: Every tender or delivery of goods must fully comply with all provisions of the Purchase Order as to time of delivery, quality and the like. If a tender is made which does not fully conform, this shall constitute a breach and Seller shall not have the right to substitute a conforming tender.
- 2.6 Place of Delivery: The place of delivery shall be that set forth in the block of the purchase order entitled "Ship To". Any change thereto shall be effective by modification as provided for in Clause number 2.20 "Modifications", hereof. The terms of this agreement are "no arrival, no sale", at the discretion of Fort Bend County.
- 2.7 Invoices and Payments:
 - 2.7.1 Seller shall submit separate invoices, in duplicate. Invoices shall indicate the purchase order number and the bid number if applicable. Invoices shall be itemized and transportation charges, if any, shall be listed separately. A copy of the bill of lading, and the freight waybill when applicable should be attached to the invoice.
 - 2.7.2 Fort Bend County's obligation is payable only and solely from funds available for the purpose of this purchase. Lack of funds shall render the order null and void to the extent funds are not available and any delivered but unpaid goods will be returned to Seller by the county.
 - 2.7.3 Do not include Federal Excise, State, or City Sales Tax. Fort Bend County is a tax-exempt governmental entity.

Initials of Bidder: 

- 2.8 Gratuities: Fort Bend County may, by written notice to the Seller, cancel any order without liability, if it is determined by the County that gratuities, in the form of entertainment, gifts, or otherwise were offered or given by the Seller, or any agent or representative of the Seller to any officer or employee of Fort Bend County with a view toward securing an order. In the event an order is canceled by the County pursuant to this provision, the County shall be entitled, in addition to any other rights and remedies, to recover or withhold the amount of the cost incurred by Seller in providing such gratuities.
- 2.9 Special Tools and Test Equipment: If the price stated on the face of an order includes the cost of any special tooling or special test equipment fabricated or required by Seller for the purpose of filing this order, such special tooling equipment and any process sheets related thereto shall become the property of the County and to the extent feasible shall be identified by the Seller as such.
- 2.10 Warranty/Price:
- 2.10.1 The price to be paid by the County shall be that contained in Seller's quote or bid which Seller warrants to be no higher than Seller's current prices on orders by others for products of the kind and specification covered by an order for similar quantities under similar or like conditions and methods of purchase. In the event Seller breaches this warranty the prices of the items shall be reduced to the Seller's current prices on orders by others. Fort Bend County may cancel this contract without liability.
- 2.10.2 The Seller warrants that no person or selling agency has been employed or retained to solicit or secure any County order based upon any agreement or understanding for commission, percentage, brokerage, or contingent fee excepting bona fide employees of bona fide established commercial or selling agencies maintained by the Seller for the purpose of securing business. A breach or violation of this warranty gives the County the right, in addition to any other right or rights, to cancel this contract without liability.
- 2.11 Warranty Product: Seller shall not limit or exclude any implied warranties and any attempt to do so shall render an order voidable at the option of the County. Seller warrants that the goods furnished will conform to the specifications, drawings, and description listed in the bid invitation and purchase order as applicable, and to the sample(s) furnished by Seller if any. In the event of a conflict between the specifications, drawings, and descriptions, the specifications shall govern.
- 2.12 Safety Warranty: Seller warrants that the product sold to Fort Bend County shall conform to the standards promulgated by the U.S. Department of Labor under the Occupational Safety and Health Act of 1970. In the event the product does not conform to OSHA standards, the County may return the product for correction or

replacement at the Seller's expense. In the event Seller fails to make the appropriate correction within 10 days, correction made by the County will be at Seller's expense.

- 2.13 **No Warranty by Fort Bend County Against Infringements:** As part of a contract for sale Seller agrees to ascertain whether goods manufactured in accordance with the specifications will give rise to the rightful claim of any third person by way of infringement. Fort Bend County makes no warranty that the production of goods according to the specification will not give rise to such a claim and in no event shall Fort Bend County be liable to Seller for indemnification in the event the Seller is sued on the grounds of infringement or the like. If Seller is of the opinion that an infringement will result, he will notify Fort Bend County to this effect in writing within two days after the receiving Purchase Order. If the County does not receive notice and is subsequently held liable for the infringement, Seller will defend and save the County harmless. If Seller in good faith ascertains that production of the goods in accordance with the specifications will result in infringement, this contract shall be null and void except that the County will pay Seller the reasonable cost of his search as to infringements.
- 2.14 **Right of Inspection:** The County shall have the right to inspect the goods at delivery before accepting them.
- 2.15 **Cancellation:** Fort Bend County shall have the right to cancel for default all or any part of the undelivered portion of an order if Seller breaches any of the terms hereof including warranties of Seller, or if the Seller becomes insolvent or files for protection under the bankruptcy laws. Such rights of cancellation are in addition to and not in lieu of any other remedies, which Fort Bend County may have in law or equity.
- 2.16 **Termination:** The performance of work under a Purchase Order may be terminated in whole or in part by the County in accordance with this provision. Termination of work there under shall be effected by the delivery to the Seller of a "Notice of Termination" specifying the extent to which performance of work under the order is terminated and the date upon which such termination becomes effective. Such right of termination is in addition to and not in lieu of rights of Fort Bend County set forth in Clause 15 herein.
- 2.17 **Force Majeure:** Force Majeure means a delay encountered by a party in the performance of its obligations under this Agreement, which is caused by an event beyond the reasonable control of that party. Without limiting the generality of the foregoing, "Force Majeure" shall include but not be restricted to the following types of events: acts of God or public enemy; acts of governmental or regulatory authorities; fires, floods, epidemics or serious accidents; unusually severe weather conditions; strikes, lockouts, or other labor disputes; and defaults by subcontractors.

In the event of a Force Majeure, the affected party shall not be deemed to have violated its obligations under this Agreement, and the time for performance of any obligations of that party shall be extended by a period of time necessary to overcome the effects of the Force Majeure, provided that the foregoing shall not prevent this Agreement from terminating in accordance with the termination provisions. If any event constituting a Force Majeure occurs, the affected party shall notify the other parties in writing, within twenty-four (24) hours, and disclose the estimated length of delay, and cause of the delay.

- 2.18 Assignment-Delegation: No right or interest in an order shall be assigned or delegation of any obligation made by Seller without the written permission of Fort Bend County. Any attempted assignment or delegation by Seller shall be wholly void and totally ineffective for all purposes unless made in conformity with this paragraph.
- 2.19 Waiver: No claim or right arising out of a breach of any contract can be discharged in whole or in part by a waiver or renunciation of the claim or right unless the waived or renunciation is supported by consideration and is in writing signed by the aggrieved party.
- 2.20 Modification: A Purchase Order can be modified or rescinded only by a writing signed by both of the parties or their duly authorized agents.
- 2.21 Parol Evidence: This writing is intended by the parties as a final expression of their agreement and is intended also as a complete and exclusive statement of the terms of this agreement. No course of prior dealings between the parties and no usage of the trade shall be relevant to supplement or explain any terms rendered under this agreement and shall not be relevant to determine the meaning of this agreement even though the accepting or acquiescing party has knowledge of the performance and opportunity for objection. Whenever a term defined by the Uniform Commercial Code is used in this agreement, the definition contained in the Code is to control.
- 2.22 Applicable Law: This agreement shall be governed by the Uniform Commercial Code. Whenever the term "Uniform Commercial Code" is used it shall be construed as meaning the Uniform Commercial Code as adopted in the State of Texas and in effective on the date of the purchase order.
- 2.23 Advertising: Seller shall not advertise or publish, without the County's prior consent the fact that Fort Bend County has entered into any contract, except to the extent necessary to comply with proper requests for information from an authorized representative of the federal, state, or local government.
- 2.24 Right to Assurance: Whenever the County in good faith has reason to question the other party's intent to perform. The County may demand that the other party give written assurance of his intent to perform. In the event that a demand is

Initials of Bidder: 

made and no assurance is given within five (5) days, the County may treat this failure as an anticipatory repudiation of the contract.

- 2.25 Venue: Both parties agree that venue for any litigation arising from this contract shall lie in Richmond, Fort Bend County, Texas.
- 2.26 Prohibition Against Personal Interest in Contracts: No officer or employee of the County shall have a financial interest, direct or indirect, in any contract with the County, or shall be financially interested, directly or indirectly, in the sale to the County of any land, materials, supplies, or service, except on behalf of the County as an officer or employee. Any willful violation of this section shall constitute malfeasance in office, and any officer or employee guilty thereof shall be subject to disciplinary action under applicable laws, statutes and codes of the State of Texas. Any violation of this section, with the knowledge, expressed or implied of the person or corporation contracting with the County shall render the contract involved voidable by the County Commissioners Court.

3.0 SCOPE:

It is the intent of Fort Bend County to contract with one (1) vendor for the purchase of helicopter navigation system equipment for the Sheriff's Office, which meets or exceeds the specifications contained herein.

4.0 DELIVERY:

Bidder agrees, if awarded the contract, to deliver all equipment **within 45 calendar days** after issuance of a purchase order by the County Purchasing Agent.

5.0 BID DOCUMENT COMPLETION:

Fill out, initial each page, SIGN CONTRACT SHEET, and return ONE (1) complete bid document to the Fort Bend County Purchasing Department. An authorized representative of the bidder MUST sign the contract sheet. The bid document must be in a sealed envelope and marked with the appropriate bid number and title. The contract will be binding only when signed by the County Judge, Fort Bend County and a purchase order authorizing the item(s) desired has been issued. The use of liquid paper is **NOT** acceptable and may result in the disqualification of bid. If an error is made, vendor **MUST** draw a line through error and initial each change. All response, typed or written information, must be clear and legible.

6.0 MODIFICATIONS:

This instrument contains the entire Contract between the parties relating to the rights herein granted and obligations herein assumed. Any oral or written representations or modifications concerning this instrument shall be of no force and effect excepting a subsequent written modification signed by both parties hereto.

Initials of Bidder: 

7.0 TEXAS ETHICS COMMISSION FORM 1295:

7.1 Effective January 1, 2016 all contracts executed by Commissioners Court, regardless of the dollar amount, will require completion of Form 1295 "Certificate of Interested Parties", per the new Government Code Statute §2252.908. All vendors submitting a response to a formal Bid, RFP, SOQ or any contracts, contract amendments, renewals or change orders are required to complete the Form 1295 online through the State of Texas Ethics Commission website. Please visit: https://www.ethics.state.tx.us/whatsnew/elf_info_form1295.htm.

7.2 On-line instructions:

7.2.1 Name of governmental entity is to read Fort Bend County.

7.2.2 Identification number used by the governmental entity is the solicitation number: B16-071.

7.2.3 Description is the title of the solicitation: Helicopter Navigation System.

7.3 Apparent low bidder(s) will be required to provide the Form 1295 within three (3) calendar days from notification. In the event the vendor does not provide the document in the stated time period the vendor's response will be marked as disqualified and the next low bidder will be contacted

8.0 AWARD:

This contract will be awarded to the overall lowest and best bid.

9.0 REQUIRED EQUIPMENT AND PRICING:

Bidder must state the make and model bid in the space provided. Failure to do so may result in disqualification of bid. Equipment bid must meet or exceed the following specifications. All equipment to be new, current production model. Specifications may reference name brand and model number; it is not the intent of Fort Bend County to restrict this bid but to establish a desired quality level of equipment. Vendors may offer item of equal stature and the burden of proof of such stature rests with them. Fort Bend County shall act as sole judge in determining equality and acceptability of products offered (See Section 1.18 above). Price to include one (1) week on-site training, conversion of any County supplied GIS data and three (3) year warranty. All prices FOB Fort Bend County, Richmond, Texas.

<u>Description</u>	<u>Qty</u>	<u>Unit Price</u>	<u>Total Price</u>
Churchill navigation augmented reality mapping System for use with FLIR 8500 sensor, full version ARS systems with overlay over video and camera steering, Item #ARS-600C	1 each	\$ 115,000	\$ 115,000

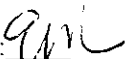
Initials of Bidder: 

<u>Description</u>	<u>Qty</u>	<u>Unit Price</u>	<u>Total Price</u>
Inertial navigation system, Honeywell IMU, GNSS Item #NOV-INS	1 each	\$ 25,000	\$ 25,000
Analog to HD/SD-SDI convertor (to convert the FLIR 8500 video to digital for input into ARS), Item #AJA-CONV-D	1 each	\$ 900	\$ 900
Serial bypass switch and cable, Item #ARS-SERBY	1 each	\$ included	\$ included
NVIS Keyboard, rack mount, Item #ARS-KB-R	1 each	\$ 2,000	\$ 2,000
GNSS antenna, external, Item #NOV-PRO-ANT	1 each	\$ 675	\$ 675
Total price FOB Fort Bend County		\$ 143,575	

List make and models bid if bidding a substitute.

10.0 REQUIRED FORMS:

All vendors submitting are required to complete the attached and return with submission:

- 10.1 Vendor Form
- 10.2 W9 Form
- 10.3 Tax Form/Debt/Residence Certification
- 10.4 Contractor Acknowledgement of Stormwater Management Program

Initials of Bidder: _____

**CONTRACT SHEET
B16-071**

**THE STATE OF TEXAS
COUNTY OF FORT BEND**

This memorandum of agreement made and entered into on the 12 day of April, 2016,
by and between Fort Bend County in the State of Texas (hereinafter designated County), acting herein by
County Judge Robert Hebert, by virtue of an order of Fort Bend County Commissioners Court, and
Churchill Navigation, Inc. (hereinafter designated Contractor).
(company name)

WITNESSETH:

The Contractor and the County agree that the bid and specifications for **Helicopter Navigation System** which are hereto attached and made a part hereof, together with this instrument and the bond (when required) shall constitute the full agreement and contract between parties and for furnishing the items set out and described; the County agrees to pay the prices stipulated in the accepted bid.

It is further agreed that this contract shall not become binding or effective until signed by the parties hereto and a purchase order authorizing the items desired has been issued.

Executed at Richmond, Texas this 12 day of April, 2016.

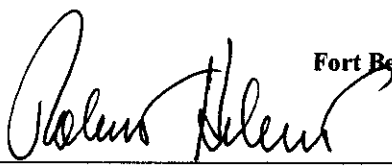
By:  **Fort Bend County, Texas**
Robert Hebert, County Judge

By: 
Signature of Contractor

By: Erin E. Murphy, Director of Sales
Printed Name and Title



COUNTY PURCHASING AGENT
Fort Bend County, Texas

Gilbert D. Jalomo, Jr., CPPB
County Purchasing Agent

(281) 341-8640
Fax (281) 341-8642 or 341-8645

Vendor Information

Federal ID # or S.S #		Dun and Bradstreet #	80-937-9600
Type of Business	<input type="checkbox"/> Corporation/LLC <input type="checkbox"/> Sole Proprietor/Individual <input type="checkbox"/> Partnership <input type="checkbox"/> Tax Exempt Organization		
Legal Company Name	Churchill Navigation	Year Business was Established	2005
Remittance Address	5660 Airport Blvd		
City/State/Zip	Boulder, CO 80301		
Physical Address	5660 Airport Blvd		
City/State/Zip	Boulder, Co 80301		
County	Fort Bend County	Other:	Boulder
Phone/Fax Number	Phone: (720) 744-3300	Fax:	n/a
Contact Person	Erin Murphy		
E-mail	erin@churchillnavigation.com		
Special Notes			
The Company listed above is a (check all that apply and attached certificate).	<input type="checkbox"/> DBE-Disadvantaged Business Enterprise Certification # _____ <input type="checkbox"/> SBE-Small Business Enterprise Certification # _____ <input type="checkbox"/> HUB-Texas Historically Underutilized Business Certification # _____ <input type="checkbox"/> WBE-Women's Business Enterprise Certification # _____ <input type="checkbox"/> MBE-Minority Business Enterprise Certification # _____		
Company's gross annual receipts:	<input type="checkbox"/> < \$500,000 <input type="checkbox"/> \$500,000-\$4,999,999 <input checked="" type="checkbox"/> \$5,000,000-\$16,999,999 <input type="checkbox"/> \$17,000,000-\$22,399,999 <input type="checkbox"/> >\$22,400,000		
NAICs codes (Please enter all that apply).	336413 - OTHER AIRCRAFT PARTS AND AUXILIARY EQUIPMENT MANUFACTURING 334511 - SEARCH, DETECTION, NAVIGATION, GUIDANCE, AERONAUTICAL, AND NAUTICAL SYSTEM AND INSTRUMENT MANUFACTURING 334111 - ELECTRONIC COMPUTER MANUFACTURING 541511 - CUSTOM COMPUTER PROGRAMMING SERVICES 541519 - OTHER COMPUTER RELATED SERVICES		

PLEASE NOTE: W-9 needs to be attached in order to be entered into our system

Request for Taxpayer Identification Number and Certification

**Give Form to the
 requester. Do not
 send to the IRS.**

1 Name (as shown on your income tax return). Name is required on this line; do not leave this line blank.
CHURCHILL NAVIGATION

2 Business name/disregarded entity name, if different from above

3 Check appropriate box for federal tax classification; check only one of the following seven boxes:
 Individual/sole proprietor or single-member LLC
 C Corporation
 S Corporation
 Partnership
 Trust/estate
 Limited liability company. Enter the tax classification (C=C corporation, S=S corporation, P=partnership) ▶
 Note. For a single-member LLC that is disregarded, do not check LLC; check the appropriate box in the line above for the tax classification of the single-member owner.
 Other (see instructions) ▶

4 Exemptions (codes apply only to certain entities, not individuals; see instructions on page 3):
 Exempt payee code (if any) _____
 Exemption from FATCA reporting code (if any) _____
(Applies to accounts maintained outside the U.S.)

5 Address (number, street, and apt. or suite no.)
5660 AIRPORT BLVD #101

6 City, state, and ZIP code
BOULDER, CO 80301

7 List account number(s) here (optional)

Print or type
 See Specific Instructions on page 2.

Part I Taxpayer Identification Number (TIN)

Enter your TIN in the appropriate box. The TIN provided must match the name given on line 1 to avoid backup withholding. For individuals, this is generally your social security number (SSN). However, for a resident alien, sole proprietor, or disregarded entity, see the Part I instructions on page 3. For other entities, it is your employer identification number (EIN). If you do not have a number, see *How to get a TIN* on page 3.

Note. If the account is in more than one name, see the instructions for line 1 and the chart on page 4 for guidelines on whose number to enter.

Social security number				
<table border="1" style="width: 100%; height: 20px;"> <tr> <td style="width: 25%;"></td> <td style="width: 25%;"></td> <td style="width: 25%;"></td> <td style="width: 25%;"></td> </tr> </table>				
Or				
Employer identification number				
<table border="1" style="width: 100%; height: 20px;"> <tr> <td style="width: 25%;"></td> <td style="width: 25%;"></td> <td style="width: 25%;"></td> <td style="width: 25%;"></td> </tr> </table>				

Part II Certification

Under penalties of perjury, I certify that:

- The number shown on this form is my correct taxpayer identification number (or I am waiting for a number to be issued to me); and
- I am not subject to backup withholding because: (a) I am exempt from backup withholding, or (b) I have not been notified by the Internal Revenue Service (IRS) that I am subject to backup withholding as a result of a failure to report all interest or dividends, or (c) the IRS has notified me that I am no longer subject to backup withholding; and
- I am a U.S. citizen or other U.S. person (defined below); and
- The FATCA code(s) entered on this form (if any) indicating that I am exempt from FATCA reporting is correct.

Certification instructions. You must cross out item 2 above if you have been notified by the IRS that you are currently subject to backup withholding because you have failed to report all interest and dividends on your tax return. For real estate transactions, item 2 does not apply. For mortgage interest paid, acquisition or abandonment of secured property, cancellation of debt, contributions to an individual retirement arrangement (IRA), and generally, payments other than interest and dividends, you are not required to sign the certification, but you must provide your correct TIN. See the instructions on page 3.

Sign Here Signature of U.S. person ▶ *Brian K.* Date ▶ *01/19/2016*

General Instructions

Section references are to the Internal Revenue Code unless otherwise noted.

Future developments. Information about developments affecting Form W-9 (such as legislation enacted after we release it) is at www.irs.gov/fw9.

Purpose of Form

An individual or entity (Form W-9 requester) who is required to file an information return with the IRS must obtain your correct taxpayer identification number (TIN) which may be your social security number (SSN), individual taxpayer identification number (ITIN), adoption taxpayer identification number (ATIN), or employer identification number (EIN), to report on an information return the amount paid to you, or other amount reportable on an information return. Examples of information returns include, but are not limited to, the following:

- Form 1099-INT (interest earned or paid)
- Form 1099-DIV (dividends, including those from stocks or mutual funds)
- Form 1099-MISC (various types of income, prizes, awards, or gross proceeds)
- Form 1099-B (stock or mutual fund sales and certain other transactions by brokers)
- Form 1099-S (proceeds from real estate transactions)
- Form 1099-K (merchant card and third party network transactions)

- Form 1098 (home mortgage interest), 1098-E (student loan interest), 1098-T (tuition)
- Form 1099-C (canceled debt)
- Form 1099-A (acquisition or abandonment of secured property)

Use Form W-9 only if you are a U.S. person (including a resident alien), to provide your correct TIN.

If you do not return Form W-9 to the requester with a TIN, you might be subject to backup withholding. See *What is backup withholding?* on page 2.

By signing the filled-out form, you:

- Certify that the TIN you are giving is correct (or you are waiting for a number to be issued),
- Certify that you are not subject to backup withholding, or
- Claim exemption from backup withholding if you are a U.S. exempt payee. If applicable, you are also certifying that as a U.S. person, your allocable share of any partnership income from a U.S. trade or business is not subject to the withholding tax on foreign partners' share of effectively connected income, and
- Certify that FATCA code(s) entered on this form (if any) indicating that you are exempt from the FATCA reporting, is correct. See *What is FATCA reporting?* on page 2 for further information.

Mandatory Form

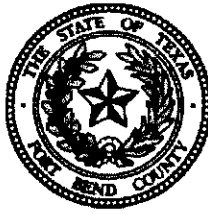

Contractor Acknowledgement of Stormwater Management Program

I hereby acknowledge that I am aware of the stormwater management program and standard operating procedures developed by Fort Bend County in compliance with the TPDES General Permit No. TXR040000. I agree to comply with all applicable best management practices and standard operating procedures while conducting my services for Fort Bend County. I agree to conduct all services in a manner that does not introduce illicit discharges of pollutants to streets, stormwater inlets, drainage ditches or any portion of the drainage system. The following materials and/or pollutant sources must not be discharged to the drainage system as a result of any services provided:

1. Grass clippings, leaves, mulch, rocks, sand, dirt or other waste materials resulting from landscaping activities, (except those materials resulting from ditch mowing or maintenance activities)
2. Herbicides, pesticides and/or fertilizers, (except those intended for aquatic use)
3. Detergents, fuels, solvents, oils and/or lubricants, other equipment and/or vehicle fluids,
4. Other hazardous materials including paints, thinners, chemicals or related waste materials,
5. Uncontrolled dewatering discharges, equipment and/or vehicle wash waters,
6. Sanitary waste, trash, debris, or other waste products
7. Wastewater from wet saw machinery,
8. Other pollutants that degrade water quality or pose a threat to human health or the environment.

Furthermore, I agree to notify Fort Bend County immediately of any issue caused by or identified by:

Churchill Navigation Inc.

(Company/Contractor)

that is believed to be an immediate threat to human health or the environment.



Contractor Signature

3/25/2014

Date

Erin E. Murphy

Printed Name

Director of Sales

Title

— THE LEADER IN AUGMENTED REALITY MAPPING —

INFORMATION IS POWER

The ARS Augmented Reality System is the most advanced mission management system available, offering a radical improvement in situational awareness.

In addition to fast display of mapping information and incorporation of satellite and synthetic imagery, ARS composites addresses, street names, parcel data and any other GIS information of interest directly on top of the live sensor video.

The ARS composited map/video image increases crew effectiveness and simplifies user workload, as all information necessary for the mission is available on a single display. This allows the operator to stay focused on the sensor target, instead of looking away for mapping and location information.

Added features such as perimeter mapping, uploading and saving marker locations and the ability to load customized and user specific imagery and data, make this the ultimate system for Law Enforcement, Fire, Search and Rescue, EMS, Pipeline and Utility companies.

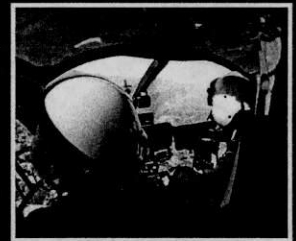
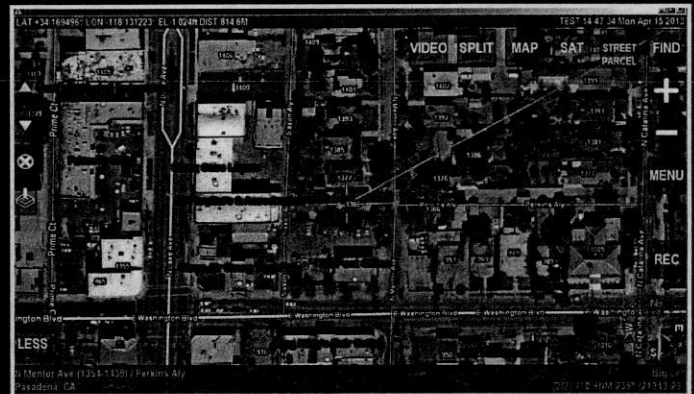

FEATURES:

- ⊕ Labeled Streets, Addresses, Business Names and Parcels Over Live Video
- ⊕ Fastest-Search Location Look-up
- ⊕ Immediate Display of Nearest Street, Cross-Street and Business Name
- ⊕ Place an Unlimited Number of Geo-markers
- ⊕ Track Speed of Vehicles on Land or Water
- ⊕ Multiple Orientation Views
- ⊕ Import Predefined Mission Targets
- ⊕ Proven Gimbal Interfaces Include: L-3 Wescam, FLIR Systems, Axsys, Gyrocam, and many more...
- ⊕ Search Light Control
- ⊕ Compact and Lightweight (less than 5.9 lbs.)
- ⊕ 100% Money Back Satisfaction Guarantee

UNRIVALED SUPPORT AND WARRANTY

ARS includes a 3 year warranty on hardware. NO ANNUAL FEE and NO CHARGE for Training, Technical Support, Customization, Custom Data.

DETAILED MAP IMAGERY:

- ⊕ High Resolution Aerial Imagery
- ⊕ Enhanced USGS Topographic Charts
- ⊕ FAA Sectional Terminal Area Charts
- ⊕ Nautical Charts
- ⊕ Helicopter Route Charts
- ⊕ Digital Elevation Models
- ⊕ Custom & Customer Supplied Data

DUAL CHANNEL HD/SD DIGITAL VIDEO RECORDER:

- ⊕ High Definition (720p, 1080i, 1080p) Recording
- ⊕ Standard Definition Recording
- ⊕ Metadata Recording
- ⊕ Audio Recording
- ⊕ Simultaneous Playback While Recording
- ⊕ User Defined Recording Buffer
- ⊕ Records Using SD or USB Media Sources

ARS AUGMENTED REALITY SYSTEM TECHNICAL SPECIFICATIONS:

Dimensions:	7.1" W x 5" H x 7.8" L
Weight:	5.9 lbs./2.5 kg
Power:	28 VDC nom
Interfaces:	6x RS-232 1x RS-422 2x Ethernet (GigE) 4x HD SDI input DVI out Display Port out VGA out 12 & 5 VDC aux out Audio in/out (stereo) 7x USB 2x 2.5" SSD

ARS: Augmented Reality Mapping System



▶ Command The Mission ◀

▶ Control The Scene ◀

▶ Never Look Away From The Target ◀

CABLING REQUIREMENTS

In order to ensure a properly working Churchill Navigation Mission Management System, these cabling requirements are highly recommended and any variations will be at the sole responsibility of the installer.

All connections should use lacing brackets and zipties (provided) unless the connector is locking.

Case must be grounded at case grounding point to aircraft frame

SDI COAX CABLE

Option A
PicWire PIC V73263 is highly recommended. The proper connector is Amphenol Connex 282118-75 (DIN 1.0/2.3). There are (2) of these connectors included in the ARS Connector Kit. Additional connectors are available from <http://www.amphenolconnex.com/282118-75.html>

Option B
RG59 is also highly recommended. The proper connector is Amphenol Connex 282135-75 (DIN 1.0/2.3). There are (2) of these connectors included in the ARS Connector Kit. Additional connectors are available from <http://www.amphenolconnex.com/282135-75.html>

Do not use inline DIN 1.0/2.3 to BNC adapters.

Option B

if RG179 is required by other equipment (ex. MX-10 gimbal), then for EMI purposes, DOUBLE high performance 360 degree EMC individual braid shielding must be done to RG179 cable from end to end.

The proper connector is Amphenol Connex 282103-75 (DIN 1.0/2.3). There are (2) of these connectors included in the ARS Connector Kit. Additional connectors are available from <http://www.amphenolconnex.com/282103-75.html>

CRIMPING TOOL

You will need the amphenol connex crimping tool to properly attach the connectors to the SDI COAX. This can be purchased directly from Digikey, <http://www.digikey.com/product-detail/en/47-10150/ACX1394-NP/1012071>

USB CABLE

Option A
Carlisle 28433/02171 LX-4 <http://www.carlisleit.com/product/usb-cables>. This cable can be purchased directly from Carlisle

Option B

EMTEQ U090-0422-100: http://www.emteq.com/cmsdocuments/EMTEQ_U090-0422-100.pdf & <http://www.emteq.com/entertainment.php>. This cable can be purchased directly from Emteq.

DVI CABLE

We highly recommend Carlisle Interconnect Technologies cable. The cable part number is 600-28952-XXX, where XXX is the length in inches. Carlisle will pre-terminate the cables. They can be contacted at (800) 327-9473 or (414) 421-5300.

VGA CABLE

We highly recommend Electronic Cable Specialists (ECS) cable. The cable part number is ECS 453005: <http://www.carlisleit.com/sites/default/files/resources/literature/453005.pdf>. This cable can be purchased directly from Carlisle.

ALL OTHER CABLES - MUST BE SHIELDED

All other cable can be selected by installer and all cables must be shielded, including power cables.

CHURCHILL

N A V I G A T I O N

PROPRIETARY AND CONFIDENTIAL
THE INFORMATION CONTAINED IN THIS DRAWING IS THE SOLE PROPERTY OF CHURCHILL NAVIGATION. ANY REPRODUCTION IN PART OR AS A WHOLE WITHOUT THE WRITTEN PERMISSION OF CHURCHILL NAVIGATION IS PROHIBITED.

CHURCHILL NAVIGATION	
NAME	DATE
JLH	1/27/16
DRAWN	
CHECKED	
ENG APPR.	
MFG APPR.	
G.A.	
COMMENTS:	
ALL DIM IN MM (IN)	
WEIGHT IN LBS (KG)	
DO NOT SCALE DRAWING	
TITLE:	
ARS-600* INSTALLATION DIAGRAM	
SIZE	DWG. NO.
A	ARS-600
REV	REV
11	11
*includes all ARS-600 versions	
SHEET 1 OF 10	

Connector Kit Contents

P/N	DESCRIPTION	ITEM	QTY	TYP
ARS-600-101	CONTROLLER ASSY	1	1	KIT
ARS-600-102	SS BUTTON HEAD SOCKET CAP SCREW, M5 x 20, 0.8 PITCH	2	4	EA
ARS-600-103	SS FLAT WASHER, M5 SIZE, 10mm OD	3	4	EA
ARS-600-104	USB CONNECTOR W/ SHELL, LOCKING TE #2013798-1	4	3	EA
ARS-600-105	DB9 CONNECTOR, 9 x FEMALE PINS TE #M24308/2-281, #205090-1	5	3	EA
ARS-600-106	DB9 SHELL TE #5748676-1	6	3	EA
ARS-600-107	DB50 CONNECTOR, 50 x MALE PINS TE #1-1757819-0, #205089-1	7	1	EA
ARS-600-108	DB50 SHELL TE #5748676-5	8	1	EA
ARS-600-109	SSD Drive Bay Key, Triangular	9	1	EA
ARS-600-110	28V LEMO PLUG, 2 x MALE PINS LEMO #FGN.1M.302.XLCY	10	1	EA
ARS-600-111	AUX LEMO PLUG, 5 x MALE PINS LEMO #FGN.0M.305.XLCT	11	1	EA
ARS-600-112	HD-SDI Amphenol Connex 282135-75 (DIN1.0/2.3)	12	2	EA
ARS-600-113	HD-SDI Amphenol Connex 282103-75 (DIN1.0/2.3)	13	2	EA
ARS-600-114	Lockit HDMI Lading Bracket	14	6	EA
ARS-600-115	Din 6 pin with crimp contacts CUI #MD-60 and CUI #T-0006	15	2	EA
ARS-600-116	HD-SDI Amphenol Connex 282118-75 (DIN 1.0/2.3)	16	2	EA
ARS-600-117	Panda 300Mbps Wireless-N USB Adapter 802.11 n, 2.4Ghz	17	1	EA
ARS-600-118	Lemo Strain Relief Heatshrink Backshell P/N: 202A111-25/86-0	18	2	EA

CHURCHILL NAVIGATION	
TITLE: ARS-600* INSTALLATION DIAGRAM	
SIZE	DWG. NO. ARS-600
*Includes all ARS-600 versions	
REV	11
SHEET 2 OF 10	

NAME	DATE
JLH	1/27/16
DRAWN	
CHECKED	
ENG APPR.	
MFG APPR.	
G.A.	

ALL DIM IN MM [IN]
WEIGHT IN LBS [KG]

DO NOT SCALE DRAWING

PROPRIETARY AND CONFIDENTIAL
THE INFORMATION CONTAINED IN THIS DRAWING IS THE SOLE PROPERTY OF CHURCHILL NAVIGATION. ANY REPRODUCTION IN PART OR AS A WHOLE WITHOUT THE WRITTEN PERMISSION OF CHURCHILL NAVIGATION IS PROHIBITED.

5 3 2 1



SYSTEM WEIGHT: 5.91lbs [2.68 kg]
±0.09 lbs [0.04 kg]

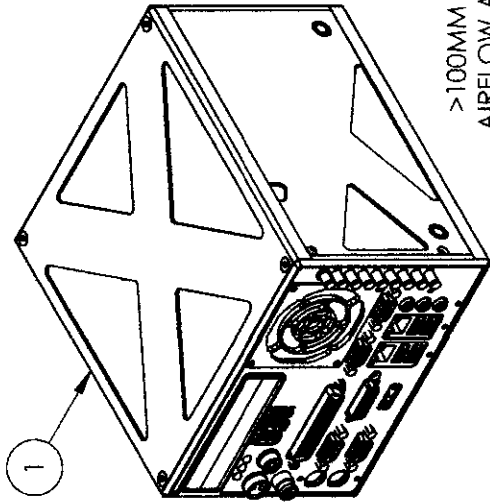

>100MM CLEARANCE FOR
AIRFLOW AND CONNECTORS.

>50MM CLEARANCE FOR
AIRFLOW. 100MM PREFERRED.

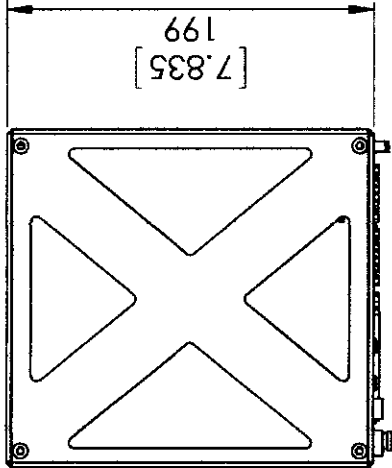

4 x M5-0.8 Mounting Holes

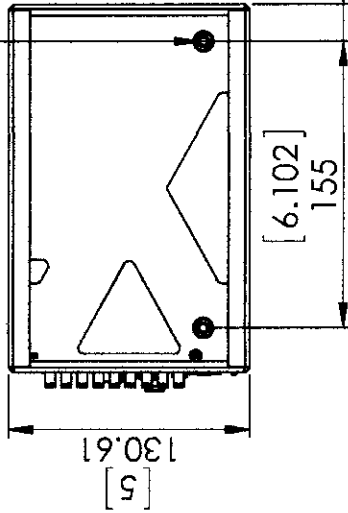

RIGHT SIDE

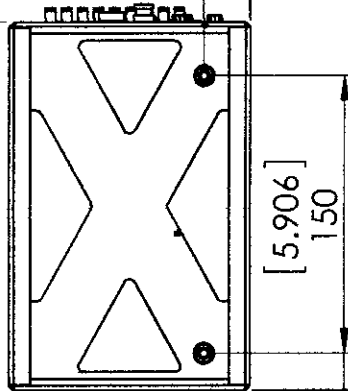
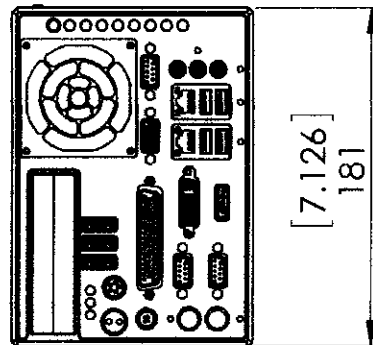

LEFT SIDE

ASSEMBLY NOTES:
1. MOUNTING HOLES (M5-0.8) HAVE A MAXIMUM DEPTH OF 17.5MM. DO NOT EXCEED.

PROPRIETARY AND CONFIDENTIAL
THE INFORMATION CONTAINED IN THIS DRAWING IS THE SOLE PROPERTY OF CHURCHILL NAVIGATION. ANY REPRODUCTION IN PART OR AS A WHOLE WITHOUT THE WRITTEN PERMISSION OF CHURCHILL NAVIGATION IS PROHIBITED.

CHURCHILL
NAVIGATION

CHURCHILL NAVIGATION

TITLE:

ARS-600* INSTALLATION
DIAGRAM

*Includes all ARS-600 versions

NAME	DATE
DRAWN JLH	1/27/16
CHECKED	
ENG APPR.	
MFG APPR.	
G.A.	

ALL DIM IN MM [IN]
WEIGHT IN LBS [KG]

DO NOT SCALE DRAWING

SIZE DWG. NO. REV
A ARS-600 11

SHEET 3 OF 10

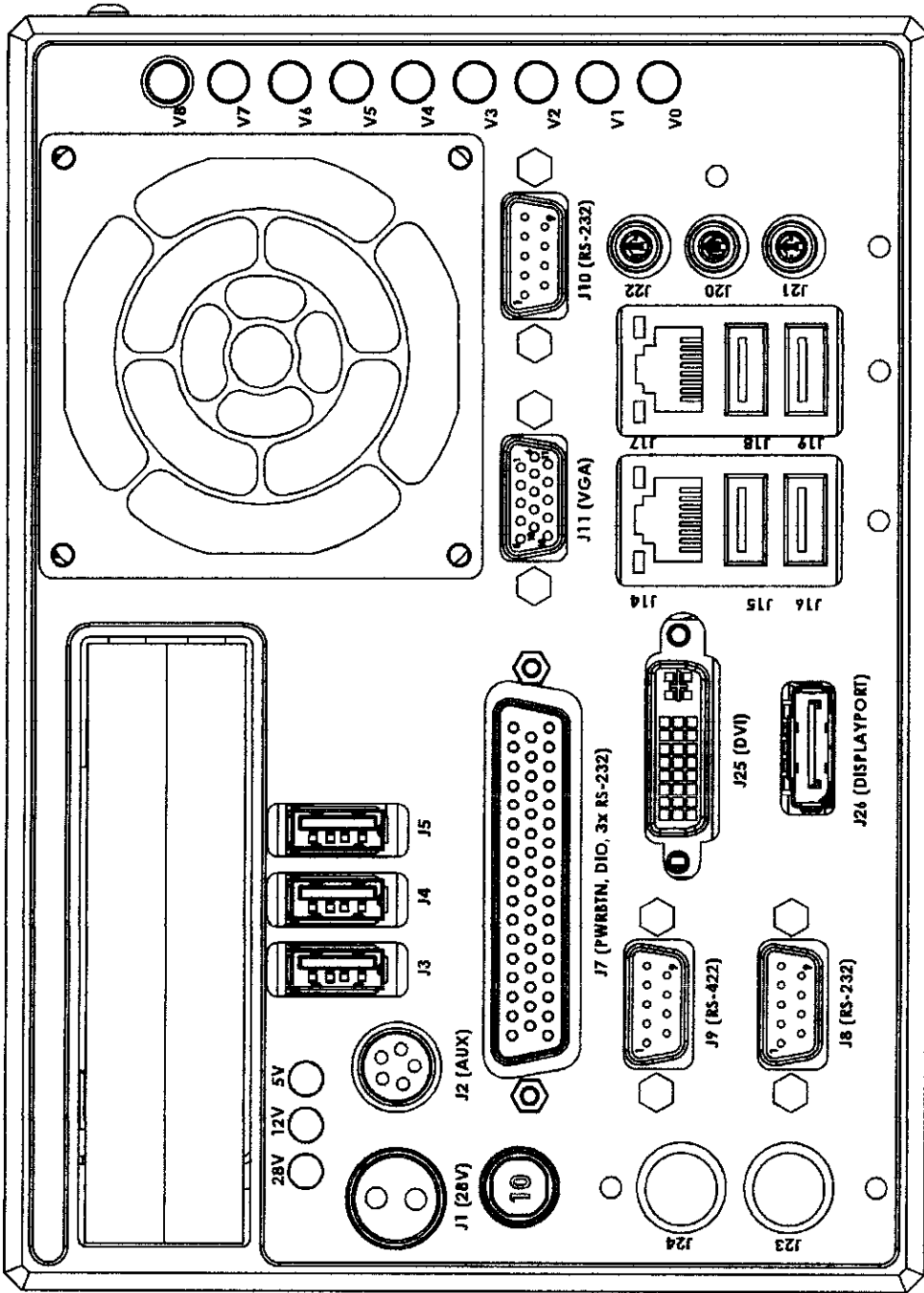

BULKHEAD	CONNECTION
J1	28 INPUT
J2	5V/12V OUTPUT
J3	USB1
J4	USB2
J5	USB3
J7	DB50
J8	RS-232 SERIAL
J9	RS-422 SERIAL
J10	RS-232 SERIAL
J11	VGA VIDEO
J14	ETHERNET
J15	USB 4
J16	USB 5
J17	ETHERNET
J18	USB 6
J19	USB 7
J20	PHONE
J21	MIC
J22	LINE IN
J23	KEYBOARD
J24	MOUSE
J25	DVI VIDEO
J26	DISPLAYPORT
V0-V8	HD-SDI VIDEO

CHURCHILL NAVIGATION

TITLE:

ARS-600* INSTALLATION DIAGRAM

*Includes all ARS-600 versions

SIZE	DWG. NO.	REV
A	ARS-600	11

NAME	DATE
DRAWN	JLH 1/27/16
CHECKED	
ENG APPR.	
MFG APPR.	
G.A.	

COMMENTS:

ALL DIM IN MM [IN]
WEIGHT IN LBS [KG]

DO NOT SCALE DRAWING

PROPRIETARY AND CONFIDENTIAL
THE INFORMATION CONTAINED IN THIS DRAWING IS THE SOLE PROPERTY OF CHURCHILL NAVIGATION. ANY REPRODUCTION IN PART OR AS A WHOLE WITHOUT THE WRITTEN PERMISSION OF CHURCHILL NAVIGATION IS PROHIBITED.

CHURCHILL

NAVIGATION

ARS-600 FRONT PANEL

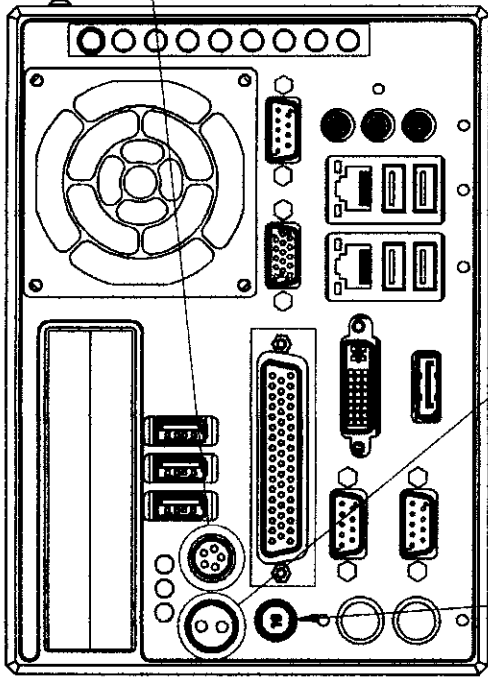

10 AMP FUSE:
28V+ LINE

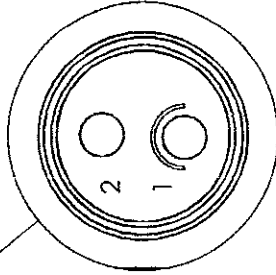

J1: 28V INPUT

PIN2. V+ (18-36V)
PIN1. GND

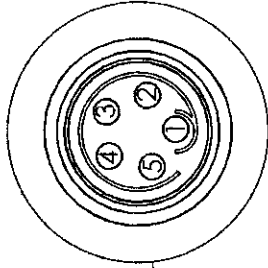

J2: AUX OUTPUT

PIN1. n/c
PIN2. GND
PIN3. V+ (5V)
PIN4. V+ (12V)
PIN5. GND

ASSEMBLY NOTES:

1. AUX POWER OUTPUTS ARE INTERNALLY FUSED WITH SELF-RESETTING FUSES.
2. 12V OUTPUT IS RATED FOR A MAXIMUM OF 2AMPS.
3. 12V OUTPUT RANGE IS 11.5-12.2V.
4. 5V OUTPUT IS RATED FOR A MAXIMUM OF 5 AMPS.
5. 5V OUTPUT RANGE IS 4.5-5.2V.
6. 12V LED AND 5V LED INDICATE VALID OUTPUTS.
7. NOTE: SHORT CIRCUIT POWER MAY BE AS HIGH AS 2 WATTS.
8. RECOMMENDED WIRE SIZE: 22 AWG.

ASSEMBLY NOTES:

1. ARS-600 IS CASE GROUNDED. ALL CONNECTOR SHIELDS AND ALL GROUND PINS ARE CONTINUOUS.
2. 28V INPUT IS REVERSE-POLARITY PROTECTED.
3. 28V INPUT IS FUSED FOR 10 AMP MAX CURRENT. AT 28V INPUT, SYSTEM SHOULD NOT EXCEED 7.5A DRAW.
4. 10 AMP FUSE: PULL OUT TO DISCONNECT SYSTEM POWER.
5. 28V LED (ON) INDICATES THAT 28V LINE IS DETECTED.
6. RECOMMENDED WIRE SIZE: 16AWG.
7. MAXIMUM POWER DRAW ON ARS IS 80 WATTS (2.75A ON 28VDC)

PROPRIETARY AND CONFIDENTIAL
THE INFORMATION CONTAINED IN THIS DRAWING IS THE SOLE PROPERTY OF CHURCHILL NAVIGATION. ANY REPRODUCTION IN PART OR AS A WHOLE WITHOUT THE WRITTEN PERMISSION OF CHURCHILL NAVIGATION IS PROHIBITED.

CHURCHILL
NAVIGATION

NAME		DATE	CHURCHILL NAVIGATION	
DRAWN	JLH	1/27/16	SIZE	DWG. NO.
CHECKED			A	ARS-600
ENG APPR.			TITLE:	ARS-600* INSTALLATION DIAGRAM
MFG APPR.				
G.A.				
COMMENTS:				
ALL DIM IN MM [IN]				REV
WEIGHT IN LBS [KG]				11
DO NOT SCALE DRAWING				SHEET 5 OF 10

*Includes all ARS-600 versions

ARS-600 FRONT PANEL

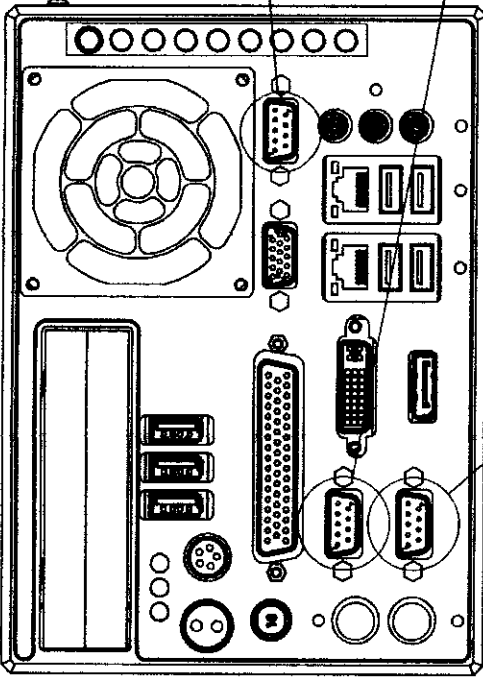

J8: DB9 PORT: RS-232
 PIN1. DCD
 PIN2. RX
 PIN3. TX
 PIN4. DTR
 PIN5. GND
 PIN6. DSR
 PIN7. RTS
 PIN8. CTS
 PIN9. RI
 SHELL = GND

J9: DB9 PORT: RS-422
 PIN1. TX-
 PIN2. TX+
 PIN3. RX+
 PIN4. RX-
 PIN5. GND
 PIN6. DSR
 PIN7. RTS
 PIN8. CTS
 PIN9. RI
 SHELL = GND

J10: DB9 PORT: RS-232
 PIN1. n/c
 PIN2. RX
 PIN3. TX
 PIN4. DTR
 PIN5. GND
 PIN6. DSR
 PINS 7-9. n/c

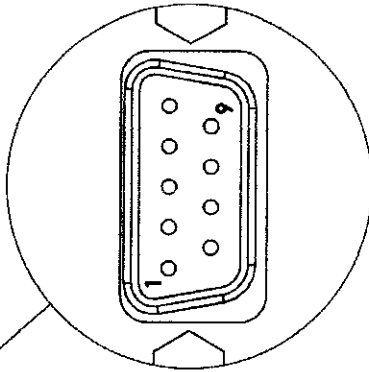
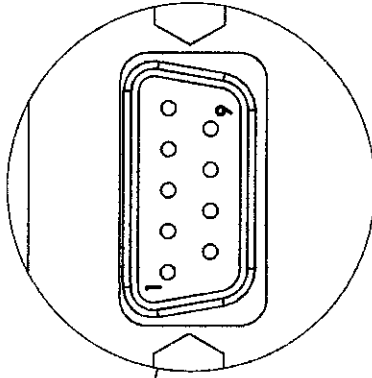
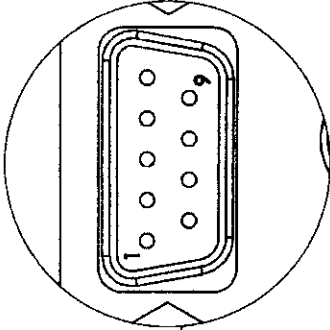

CHURCHILL NAVIGATION	
NAME	JLH
DATE	1/27/16
DRAWN	
CHECKED	
ENG APPR.	
MFG APPR.	
Q.A.	
COMMENTS:	
ALL DIM IN MM [IN] WEIGHT IN LBS [KG]	
SIZE	ARS-600
DWG. NO.	ARS-600
REV	11
*includes all ARS-600 versions	

PROPRIETARY AND CONFIDENTIAL
 THE INFORMATION CONTAINED IN THIS DRAWING IS THE SOLE PROPERTY OF CHURCHILL NAVIGATION. ANY REPRODUCTION IN PART OR AS A WHOLE WITHOUT THE WRITTEN PERMISSION OF CHURCHILL NAVIGATION IS PROHIBITED.

CHURCHILL
 NAVIGATION

ARS-600 FRONT PANEL

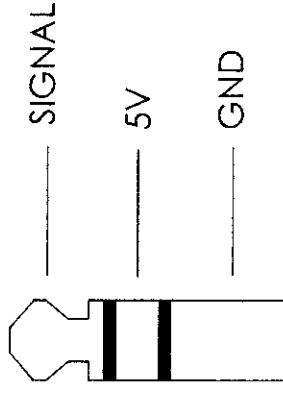
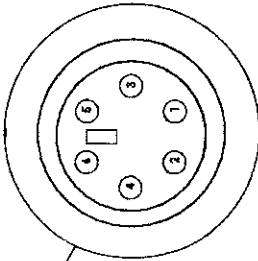
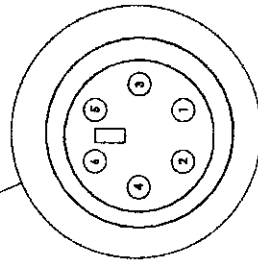
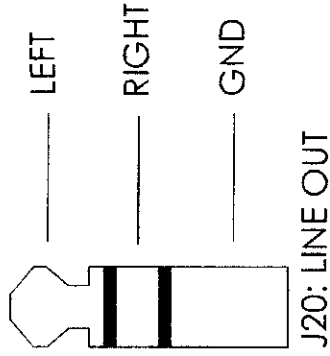
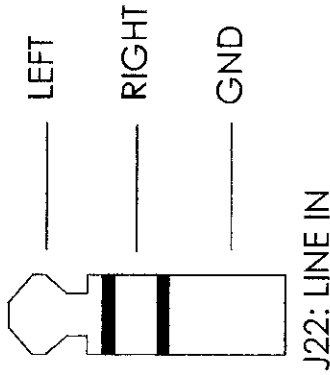
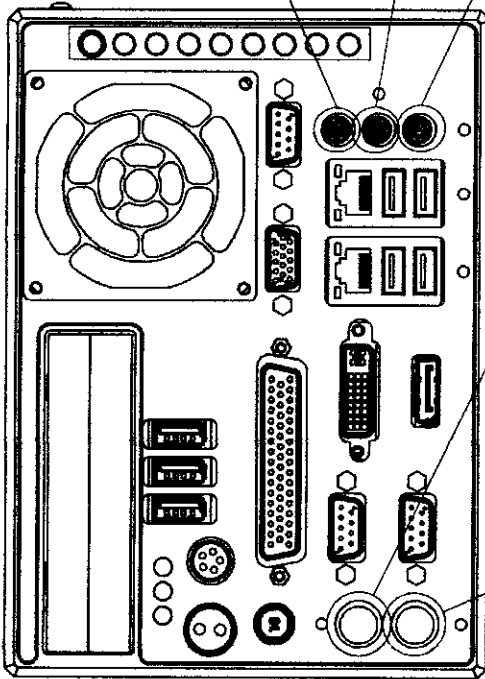

CHURCHILL NAVIGATION	
NAME	DATE
JLH	1/27/16
DRAWN	
CHECKED	
ENG APPR.	
MFG APPR.	
G.A.	
COMMENTS:	
ALL DIM IN MM [IN] WEIGHT IN LBS [KG]	
SIZE	DWG. NO.
A	ARS-600
REV	REV
	11
*Includes all ARS-600 versions	
TITLE:	
ARS-600* INSTALLATION DIAGRAM	

PROPRIETARY AND CONFIDENTIAL
 THE INFORMATION CONTAINED IN THIS
 DRAWING IS THE SOLE PROPERTY OF
 CHURCHILL NAVIGATION. ANY
 REPRODUCTION IN PART OR AS A WHOLE
 WITHOUT THE WRITTEN PERMISSION OF
 CHURCHILL NAVIGATION IS
 PROHIBITED.



ARS-600 FRONT PANEL

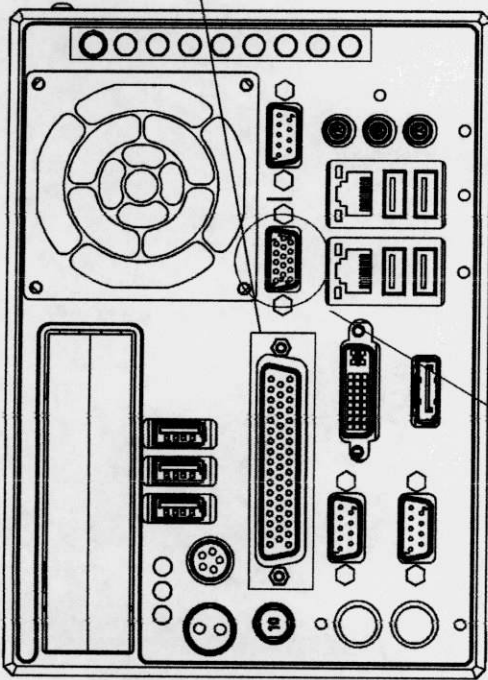

J7:DB50 PORT: PWRBTN, DIO, 3 x RS-232

PIN1. RS-232a RX	PIN18. RS-232a TX	PIN35. RS-232a GND
PIN2. N/C	PIN19. RS-232a DTR	PIN36. RS-232a DSR
PIN3. RS-232b RX	PIN20. RS-232b TX	PIN37. RS-232b GND
PIN4. N/C	PIN21. RS-232b DTR	PIN38. RS-232b DSR
PIN5. RS-232c RX	PIN22. RS-232c TX	PIN39. RS-232c GND
PIN6. N/C	PIN23. RS-232c DTR	PIN40. RS-232c DSR
PIN7. N/C	PIN24. N/C	PIN41. N/C
PIN8. N/C	PIN25. N/C	PIN42. N/C
PIN9. N/C	PIN26. N/C	PIN43. N/C
PIN10. N/C	PIN27. N/C	PIN44. N/C
PIN11. N/C	PIN28. N/C	PIN45. N/C
PIN12. DIO 12VDC	PIN29. GPIO6	PIN46. GPIO1
PIN13. DIO GND	PIN30. GPIO2	PIN47. GPIO4
PIN14. DIO GPIO7	PIN31. GPIO5	PIN48. GPIO0
PIN15. DIO GPIO3	PIN32. N/C	PIN 49. N/C
PIN16. N/C	PIN33. N/C	
PIN17. PWRBTN+	PIN34. N/C	PIN50. PWRBTN-

- PIN1. RED VIDEO
- PIN2. GREEN VIDEO
- PIN3. BLUE VIDEO
- PIN4. N/C
- PIN5. N/C
- PIN6. RED SHIELD
- PIN7. GREEN SHIELD
- PIN8. BLUE SHIELD
- PIN9. N/C
- PIN10. N/C
- PIN11. N/C
- PIN12. N/C
- PIN13. HORIZ SYNC
- PIN14. VERTICAL SYNC
- PIN15. N/C

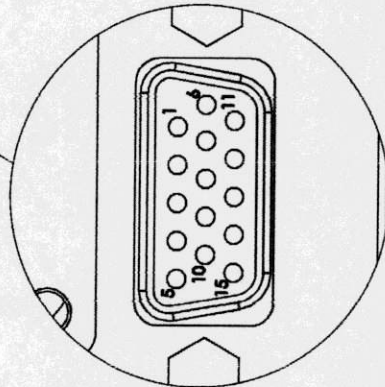

J11: HD15 PORT: VGA

CHURCHILL NAVIGATION	
TITLE: ARS-600* INSTALLATION DIAGRAM	
NAME JLH	DATE 1/27/16
DRAWN	
CHECKED	
ENG APPR.	
MFG APPR.	
Q.A.	
COMMENTS: ALL DIM IN MM [IN] WEIGHT IN LBS [KG]	
SIZE A	DWG. NO. ARS-600
REV 11	

**Includes all ARS-600 versions*

PROPRIETARY AND CONFIDENTIAL
THE INFORMATION CONTAINED IN THIS DRAWING IS THE SOLE PROPERTY OF CHURCHILL NAVIGATION. ANY REPRODUCTION IN PART OR AS A WHOLE WITHOUT THE WRITTEN PERMISSION OF CHURCHILL NAVIGATION IS PROHIBITED.



ARS-600 FRONT PANEL

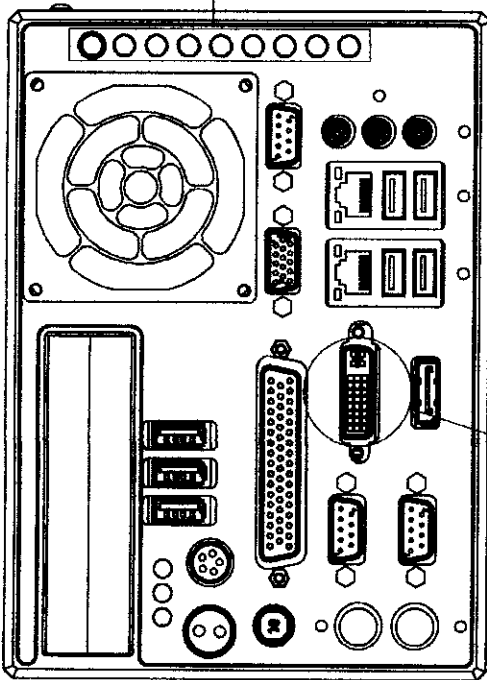

J25: DVI:

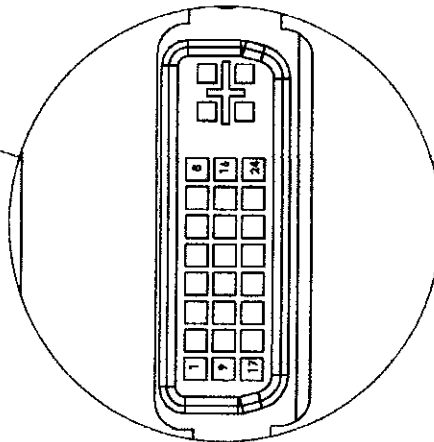

- PIN1. TMDS DATA 2-
- PIN2. TMDS DATA 2+
- PIN3. TMDS DATA SHIELD
- *PIN4. TMDS DATA 4-
- *PIN5. TMDS DATA 4+
- PIN6. DDC CLOCK
- PIN7. DDC DATA
- PIN8. N/C
- PIN9. TMDS DATA 1-
- PIN10. TMDS DATA 1+
- PIN11. TMDS DATA SHIELD
- *PIN12. TMDS DATA 3-
- *PIN13. TMDS DATA 3+
- PIN14. +5V
- PIN15. GND
- PIN16. HOT PLUG DETECT
- PIN17. TMDS DATA 0-
- PIN18. TMDS DATA 0+
- PIN19. TMDS DATA SHIELD
- *PIN20. TMDS DATA 5-
- *PIN21. TMDS DATA 5+
- PIN22. TMDS CLOCK SHIELD
- PIN23. TMDS CLOCK+
- PIN24. TMDS CLOCK-

*DUAL LINK NEEDED FOR RESOLUTIONS HIGHER THAN 1920x1200

DISPLAYPORT:
 DISPLAYPORT CAN BE CONVERTED TO HDMI/DVI/VGA
 IF DESIRED. OUTPUT MUST BE SPECIFIED AT TIME OF
 ORDER AND A 6" PIGTAIL WILL BE PROVIDED

PROPRIETARY AND CONFIDENTIAL
 THE INFORMATION CONTAINED IN THIS
 DRAWING IS THE SOLE PROPERTY OF
 CHURCHILL NAVIGATION. ANY
 REPRODUCTION IN PART OR AS A WHOLE
 WITHOUT THE WRITTEN PERMISSION OF
 CHURCHILL NAVIGATION IS
 PROHIBITED.

CHURCHILL
 N A V I G A T I O N

BNC 1.0/2.3 PORTS (x9)
 HD/SD-SDI INPUT/OUTPUT

- 0. REF.
- 1. VIDEO1 IN
- 2. VIDEO1 OUT
- 3. VIDEO2 IN
- 4. VIDEO2 OUT
- 5. VIDEO3 IN
- 6. VIDEO3 OUT
- 7. VIDEO 4 IN
- 8. VIDEO 4 OUT

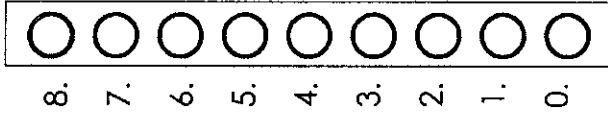

CHURCHILL NAVIGATION

TITLE:

ARS-600* INSTALLATION
 DIAGRAM

*Includes all ARS-600 versions

SIZE	DWG. NO.	REV
A	ARS-600	11

ALL DIM IN MM [IN]
 WEIGHT IN LBS [KG]

DO NOT SCALE DRAWING

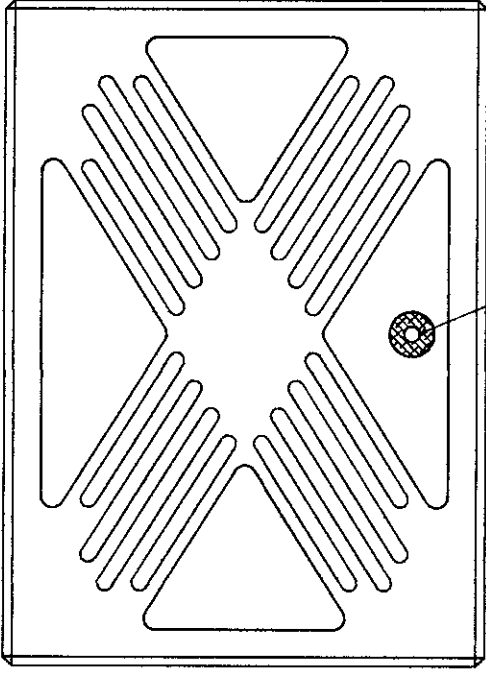

GROUNDING POINT (GROUND STRAP IS REQUIRED TO BE CONNECTED TO AIRCRAFT FRAME)

ASSEMBLY NOTES

1. HATCHED SURFACE IS CHROMATED. DO NOT CHEMICALLY COAT OR COVER WITH NON-CONDUCTIVE MATERIAL.
2. PRE-INSTALLED GROUNDING HARDWARE:
 1 x M5 X 6mm STAINLESS STEEL BOLT
 1 x AN960 FLAT WASHER
3. DO NOT MOUNT WITHIN 1M OF ANTENNAS

CHURCHILL
 NAVIGATION

PROPRIETARY AND CONFIDENTIAL
 THE INFORMATION CONTAINED IN THIS DRAWING IS THE SOLE PROPERTY OF CHURCHILL NAVIGATION. ANY REPRODUCTION IN PART OR AS A WHOLE WITHOUT THE WRITTEN PERMISSION OF CHURCHILL NAVIGATION IS PROHIBITED.

CHURCHILL NAVIGATION	
NAME	DATE
JLH	1/27/16
TITLE:	
ARS-600* INSTALLATION DIAGRAM	
SIZE	DWG. NO.
A	ARS-600
COMMENTS:	
ALL DIM IN MM [IN] WEIGHT IN LBS [KG]	
DO NOT SCALE DRAWING	
REV	REV
T1	T1
*Includes all ARS-600 versions	
SHEET 10 OF 10	

CERTIFICATE OF INTERESTED PARTIES

FORM 1295

1 of 1

Complete Nos. 1 - 4 and 6 if there are interested parties.
Complete Nos. 1, 2, 3, 5, and 6 if there are no interested parties.

OFFICE USE ONLY CERTIFICATION OF FILING

Certificate Number:
2016-35087

Date Filed:
04/05/2016

Date Acknowledged:

1 Name of business entity filing form, and the city, state and country of the business entity's place of business.

Churchill Navigation, Inc.
Boulder, CO United States

2 Name of governmental entity or state agency that is a party to the contract for which the form is being filed.

Fort Bend County

3 Provide the identification number used by the governmental entity or state agency to track or identify the contract, and provide a description of the goods or services to be provided under the contract.

Bid 16-071
Helicopter Navigation System

4 Name of Interested Party	City, State, Country (place of business)	Nature of interest (check applicable)	
		Controlling	Intermediary
Churchill Navigation Inc	Boulder, CO United States	X	

5 Check only if there is NO interested Party.

6 AFFIDAVIT

I swear, or affirm, under penalty of perjury, that the above disclosure is true and correct.

ALBERT BOGGS III
NOTARY PUBLIC
STATE OF COLORADO
NOTARY ID 20164002183
MY COMMISSION EXPIRES 01/20/2020

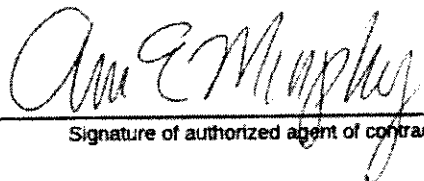

Signature of authorized agent of contracting business entity

AFFIX NOTARY STAMP / SEAL ABOVE

Sworn to and subscribed before me, by the said ERIN MURPHY, this the 5 day of APRIL, 2016, to certify which, witness my hand and seal of office.

 Signature of officer administering oath
ALBERT BOGGS III Printed name of officer administering oath
NOTARY PUBLIC Title of officer administering oath

CERTIFICATE OF INTERESTED PARTIES

FORM 1295

1 of 1

Complete Nos. 1 - 4 and 6 if there are interested parties.
Complete Nos. 1, 2, 3, 5, and 6 if there are no interested parties.

OFFICE USE ONLY CERTIFICATION OF FILING

1 Name of business entity filing form, and the city, state and country of the business entity's place of business.
Churchill Navigation, Inc.
Boulder , CO United States

Certificate Number:
2016-35087

Date Filed:
04/05/2016

2 Name of governmental entity or state agency that is a party to the contract for which the form is being filed.
Fort Bend County

Date Acknowledged:
04/12/2016

3 Provide the identification number used by the governmental entity or state agency to track or identify the contract, and provide a description of the goods or services to be provided under the contract.
Bid 16-071
Helicopter Navigation System

4	Name of Interested Party	City, State, Country (place of business)	Nature of interest (check applicable)	
			Controlling	Intermediary
	Churchill Navigation Inc	Boulder , CO United States	X	

5 Check only if there is NO Interested Party.

6 AFFIDAVIT I swear, or affirm, under penalty of perjury, that the above disclosure is true and correct.

Signature of authorized agent of contracting business entity

AFFIX NOTARY STAMP / SEAL ABOVE

Sworn to and subscribed before me, by the said _____, this the _____ day of _____, 20_____, to certify which, witness my hand and seal of office.

Signature of officer administering oath Printed name of officer administering oath Title of officer administering oath