



Owner Change Order

Project: BID 24-052 Ft Bend County Fresno Community Center FBC PURCHASE ORDER NO: 242273 Contractor: (TEALCO) Teal 1335 Brittmoore Rd Houston Texas 77043	Change Order Number: 0006 Title: Owner Change Order 03 Change Order Date: Oct 6, 2025 Architect's Project No: Contract Date: 5/14/24
---	---

Contract scope changes:

- ASI #7- Floor/Wall Tile Changes
- ASI #9- Removed Landscaping at Back of Curb
- Relocated Canopy Steel
- AV Changes from FBC Walk (CREDIT)
- Mineral Wool Insulation
- Project Delays (Permit & Weather)
- AC Condenser Roof Supports
- 3-basin Sink at Warming Kitchen
- Overrun of Signage Package
- Removal of Irrigation at Detention Pond and along Sycamore Road
- Light Pole Foundations

Original Contract Sum	6,778,000.00
Previously approved Change Orders	77,483.24
Contract Sum prior to this Change Order	6,855,483.24
Contract Sum adjustment by this Change Order	194,455.80
Revised Contract Sum including this Change Order	7,049,939.04
The Contract duration will be increased / decreased	90 days



CONTRACTOR <i>(Firm name)</i>	OWNER <i>(Firm name)</i>
(TEALCO) Teal 1335 Brittmoore Rd Houston Texas 77043	Fort Bend County 301 Jackson Street, Richmond Texas 77469
ADDRESS	ADDRESS
BY <i>(Signature)</i>	BY <i>(Signature)</i>
<i>Michael Krause</i>	
Michael Krause	KP George
<i>(Typed name)</i>	<i>(Typed name)</i>
DATE <u>12/23/2025</u>	DATE _____

Fort Bend County- Fresno Boys & Girls Club

OWNER CHANGE ORDER LOG

CPR #	Status	DESCRIPTION	SUBMIT DATE	CREDIT TO OWNER	COST TO OWNER	PROPOSED AMOUNT	DAYS REQUESTED	APPROVED AMOUNT	
01	APPROVED	Additional Select Fill / Haul off Additional Storm Material	3/3/2025				0	\$ 32,464.90	
02	APPROVED	Revised Foundation Design per PEMB reactions Modify Canopy D & E drainage (\$11,668.00)	3/4/2025				30	\$ 45,018.34	
03	PENDING	ASI #7- Floor/Wall Tile Changes per walk with end user (B&G Club)	3/5/2025		\$ 2,467.50	\$ 1,518.11	0	\$ -	
		ASI #8- Landscape Changes- Removed back of curb landscaping at North Side of parking lot			\$ (1,124.03)				
04	PENDING	Canopy support steel installed per Issue for Construction drawings released on April 12, 2024. ASI #10 released on May 6, 2025 relocated upper canopy horizontal support steel per				\$ 68,457.66	0	\$ -	
05	PENDING	Mineral Wool Insulation added in lieu of Rigid Insulation per returned Trespa panel submittal & RFI #53 response			\$ 24,000.00	\$ 2,245.31	0	\$ -	
		Removal of AV items (Credit) per walk with Fort Bend County			\$ (22,013.33)				
06	PENDING	Added General Conditions due to Weather/Construction Delays (116 total days incurred on project, 30 days captured in CO 002. Claiming 3 months at \$28,000/month in CO 06)			\$ 84,000.00	\$ 84,000.00	86	\$ -	
07	PENDING	Condensor Supporting Steel- Steel not captured in Structural drawings			\$ 25,048.71	\$ 25,048.71	0	\$ -	
08	PENDING	Warming Kitchen 3-Basin Sink- Sink called out as 3-basin drop-in sink on Plumbing Schedule and approved in submittals.			\$ 14,362.00	\$ 13,969.06	0	\$ -	
		Teal included a \$2,000 allowance for appliances.			\$ (2,000.00)				
09	PENDING	Overrun of Teal Signage Allowance (South Texas Graphics proposal is \$26,455)			\$ 26,455.00	\$ 1,242.00	0	\$ -	
		Teal included a \$25,213 allowance for building signage.			\$ (25,213.00)				
10	PENDING	Removal of irrigation at Reserve Detention Pond and at green space at Sycamore Lane				\$ (8,993.64)		\$ (8,993.64)	
11	PENDING	Site Light Pole Foundations (not shown on drawings)			\$ 6,968.59	\$ 6,968.59			
TOTAL PROPOSED						\$194,455.80	116	\$ 77,483.24	TOTAL APPROVED



Fort Bend County Fresno Boys & Girls Club
 1031 W Sycamore Rd Fresno Tx

Change Order

Change Order
No. 003

RE: **Changes for ASI #8 & ASI #9**

Date: 10/6/2025

Teal Job #24-1707

Item #	Description	Total	Contractor
1	Labor and material for tile changes captured in ASI #8	\$2,467.50	Dobbins
2	Revised Landscape/Irrigation changers per ASI #9	-\$1,124.03	Choate
	Subcontractor Subtotal	\$1,343.47	
Project Schedule - Impacts/Delays			
	Current Substantial Completion Date:	6/15/2025	No. of Days of Schedule Impact: 62 Days
			Revised Substantial Completion: 9/3/2025
Summary			
	Sub Total	\$1,343.47	
	Project Schedule Days Added (Calendar)	0	
	General Conditions (5%)	\$67.17	
	Insurance (3%)	\$40.30	
	Fee (5%)	\$67.17	
	Grand Total	\$1,518.11	
			Date: 10/6/2025
	Michael Krause - PM - Teal Construction		

Change Order

Phone: (713) 690-7390

Fax: (713) 690-7361

Dobbins Floor Covering, Inc.

2224 Hoskins Dr. Houston, TX 77080

Check one

new construction/commercial/tax on material

new construction/residential/tax on material

remodel or repair/commercial/tax entire job

remodel or repair/residential/tax on material

remodel or repair/tax exempt organization/you must submit an exemption certificate.

Submitted To: **TEAL** Attn:

Job Name: **FRESNO COMMUNITY CENTER** Date: **02/19/25**

Job Address: **FRESNO, TX** Fax #:

We hereby submit the following:

<u>Item</u>	<u>QTY</u>	<u>Cost</u>	<u>Total</u>
CWT-1	810 SQFT @	\$12.70 =	10,287.00 10-12 week lead time
CWT-2	520 SQFT @	\$12.70 =	6,604.00 10-12 week lead time
CWT-B1	195 PC @	\$12.70 =	2,476.50 10-12 week lead time
SCHLUTER	46 PC @	\$45.00 =	2,070.00
ORIGINAL BID	1 EA @	(\$18,970.00) =	(18,970.00)
		Subtotal	2,467.50
		Tax/materials	tax exempt
		Total	2,467.50

This proposal excludes: Demo X Moving of Furniture X
Moving of computers, etc. X Protection X Sales Tax X Floor Prep X
Other: _____

Respectfully submitted by Greg Dobbins

Acceptance of Proposal

My signature authorizes Dobbins Floor Covering to proceed with the labor/materials listed above. I agree as an authorized agent of above company that the items listed have been billed for within the standard pricing guidelines used in the flooring industry and Dobbins Floor Covering will be compensated in full for all items listed above.

Date of Acceptance _____ Signature _____

RFC No 01

Sarah Bottlinger
 #512.848.7871
 E: sarahb@choateusa.com

Date: 02-10-2025
 To: Teal Construction
 1335 Brittmoore Rd. | Houston, Texas 77043

Attention: Michael Krause
 Email: michaelkrause@tealcon.com

<u>Project Title & Location</u>	<u>Sheet Numbers</u>	<u>Date</u>
Fresno Community Center 1031 W. Sycamore Road Fresno, Texas 77545	L1.01, L2.01, L3.00, L3.01, L3.02, L4.01, L5.01, L5.02, L6.01, LI1.01, LI1.02	02-29-2024

Specifications: Per plan sheets listed above

Addendum: N/A

Estimator/Job ID: JSK/VID12881

Project Completion to be performed as Indicated for Sum(s) Described:

Scope of Work

Note: See Qualifications and Materials List below

No work may be performed without an executed official change order.

Irrigation:

Inclusions:

- *Modifications to the irrigation system as per the plan sheets list above.*
- *The removal of (22) ea of Hunter Pros-04 PRS30 spray heads and (1) ea Drip area with all accessories.*
- *The supply and install of additional (18) ea of Hunter PGP-04 ADJ rotors.*
- *For reference JID818254.*

Exclusions:

- *Any scope of work outside the scope listed above.*

Total Irrigation Change (**Deduct**) \$ 77.95 Init.

Landscape:

Inclusions:

- *Modifications to the landscape as per the plan sheets list above.*
- *The removal of (1) ea of Planting bed with (46) ea of Dwarf Burford Holly and all plant materials.*
- *The supply and install of additional (100) sy of Common Bermuda sod.*
- *For reference JID818256, JID818260 and JID818257.*

Exclusions:

- *Any scope of work outside the scope listed above.*
- *Turf Soil (See Below).*

Total Landscape Change (**Deduct**) \$ 1,232.48 Init.

Turf Soils:

Inclusions:

- *Modifications to the turf soils as per the plan sheets list above.*
- *The supply and install of (5) cy of Enriched Topsoil underneath the additional Common Bermuda sod as listed above.*

Exclusions:

- *Any scope of work outside the scope listed above.*

Total Turf Soils Change (**Add**) \$ 186.40 Init.

PAYMENT / PAYMENT SCHEDULE

Draw Schedule/Payments [and Retainage, if required] shall be Net 30 unless otherwise determined and agreed upon, **in writing, prior** to commencement of any work on the proposed/contracted irrigation installation site.

Contractor shall be notified of any contemplated contractor back charge, **in writing at least 7 days prior** to the back charge event. Contractor shall be given the opportunity to investigate and confirm or refute any impending or contemplated back charge before it occurs.

All monies are due at time of Final Acceptance. Written evidence of acceptance by the contractor and/or agents of contractor is signified by completion of Contractor's Acceptance Form.

Request for Change (RFC) is not considered accepted unless all appropriate initials and signatures are applied where indicated.

By: _____ Accepted By: _____
Date Date

Title: Contract Administrator, Choate USA Printed Name/Title: _____

Irrigation in Texas is regulated by the
Texas Commission on Environmental Quality (TCEQ) (MC-235)
P.O. BOX 13087, Austin, Texas 78711-3087
TCEQ's website is: www.tceq.texas.gov.

Filename: Document1 - Printed on: 2/10/2025

IMPORTANT NOTICE: You and your contractor are responsible for meeting the terms and conditions of this contract. If you sign this contract and you fail to meet the terms and conditions of this contract, you may lose your legal ownership rights to your home. KNOW YOUR RIGHTS AND DUTIES UNDER THE LAW.



Fort Bend County Fresno Boys & Girls Club
1031 W Sycamore Rd Fresno Tx

Change Order

Change Order No.

004

RE: **Relocate Upper Canopy Tube Steel per Architect's direction**

Date: 10/6/2025

Teal Job #24-1707

Item #	Description	Total	Contractor
1	Remove & Reinstall densglass & metal stud framing (1st Steel Tube Relocation - May 29)	\$14,200.00	KC Drywall
2	Material to relocate upper horizontal tube steel at all canopy locations (1st Steel Tube Relocation - May 29)	\$15,792.00	Red Dot
3	Labor to relocate upper horizontal tube steel at all canopy locations (1st Steel Tube Relocation - May 29)	\$13,990.00	Vital Steel
4	Furnish upper canopy support brackets (1st Steel Tube Relocation - May 29)	\$15,319.00	Red Dot
5	Replacement Fascia Cap to Accommodate Moving Brick Out Further than Drawings Show	\$1,281.00	Red Dot
	Subcontractor Subtotal	\$60,582.00	
Project Schedule - Impacts/Delays			
Current Substantial Completion Date:	9/3/2025	No. of Days of Schedule Impact: 14	Days
			Revised Substantial Completion: 9/24/2025
Summary			
	Sub Total	\$60,582.00	
	Project Schedule Days Added (Calendar)	0	
	General Conditions (5%)	\$3,029.10	
	Insurance (3%)	\$1,817.46	
	Fee (5%)	\$3,029.10	
	Grand Total	\$68,457.66	
	Date:	10/6/2025	
Michael Krause - PM - Teal Construction			

ARCHITECT
SMITH & COMPANY ARCHITECTS
720 N POST OAK, SUITE 124
HOUSTON, TX 77024

STRUCTURAL ENGINEER
STANLEY SPURLING & HAMILTON INC.
3301 EDDIE ST.
HOUSTON, TX 77027

CIVIL ENGINEER
LJA ENGINEERING
1504 W GRAND PARKWAY N, SUITE 100
KATY, TX 77459

LANDSCAPE ARCHITECT
STUDIO AVID
6046 FM 2920 RD, #260
SPRING, TX 77379

MEP ENGINEER
INFRASTRUCTURE ASSOCIATES
6117 RICHMOND AVE., SUITE 200
HOUSTON, TX 77057
TBPB FIRM REG # 4506

TECHNOLOGY CONSULTANT
TRUE NORTH CONSULTANT GROUP
3408 HILLOREST DR.
WACO, TX 76708

PROJECT #: N032023
DATE ISSUED: 02.29.2024
TDLR #: TABS2024011699

REVISIONS:
NO. DATE DESCRIPTION

**FRESNO BOYS & GIRLS CLUB
1031 W SYCAMORE RD
FRESNO, TX 77545**

WALL SECTIONS

100% Construction Document
02.29.2024

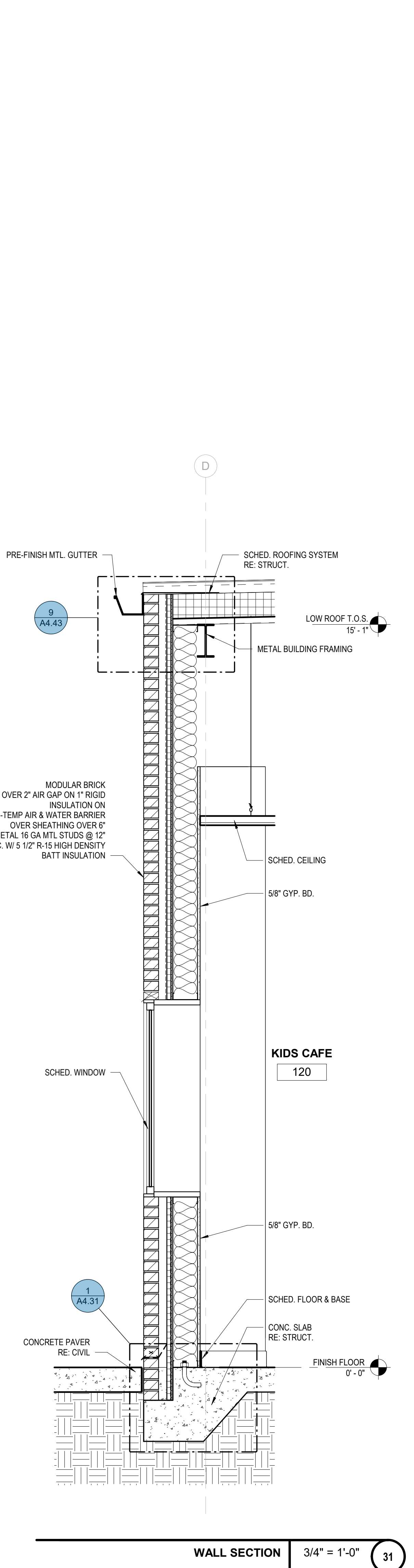
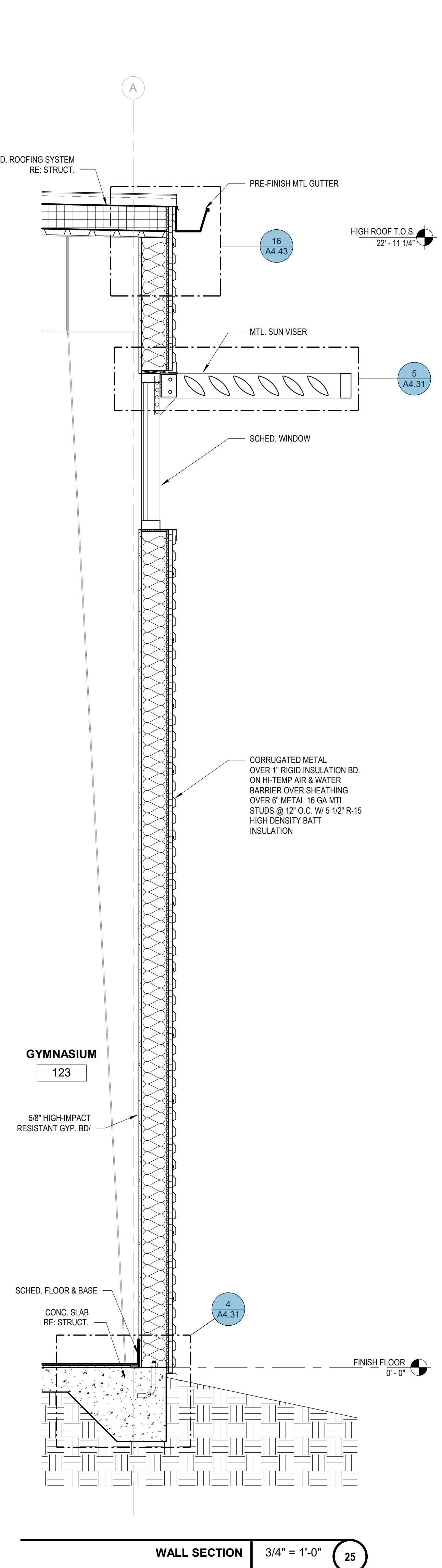
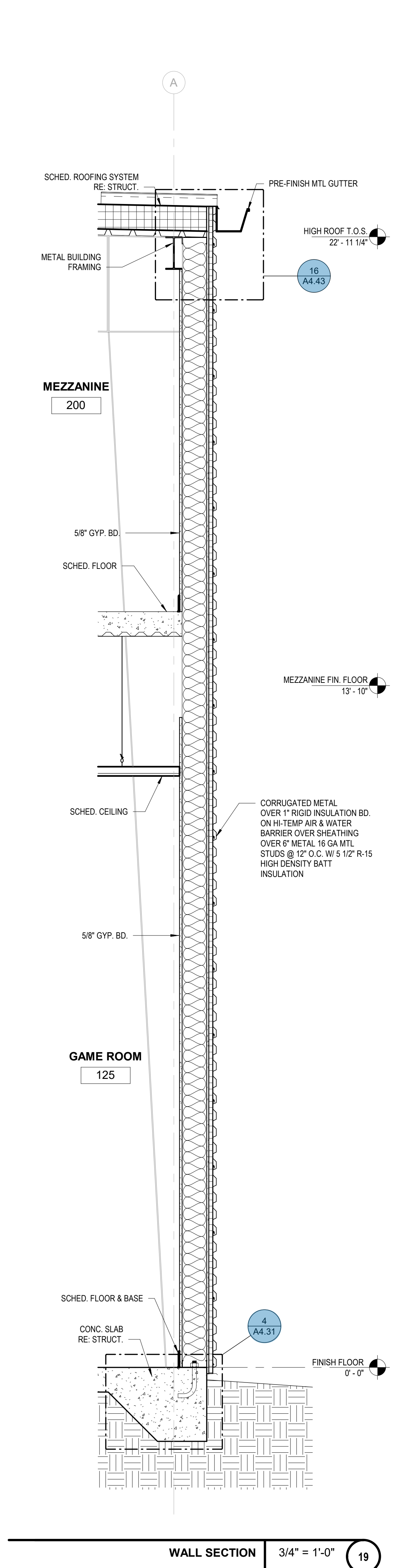
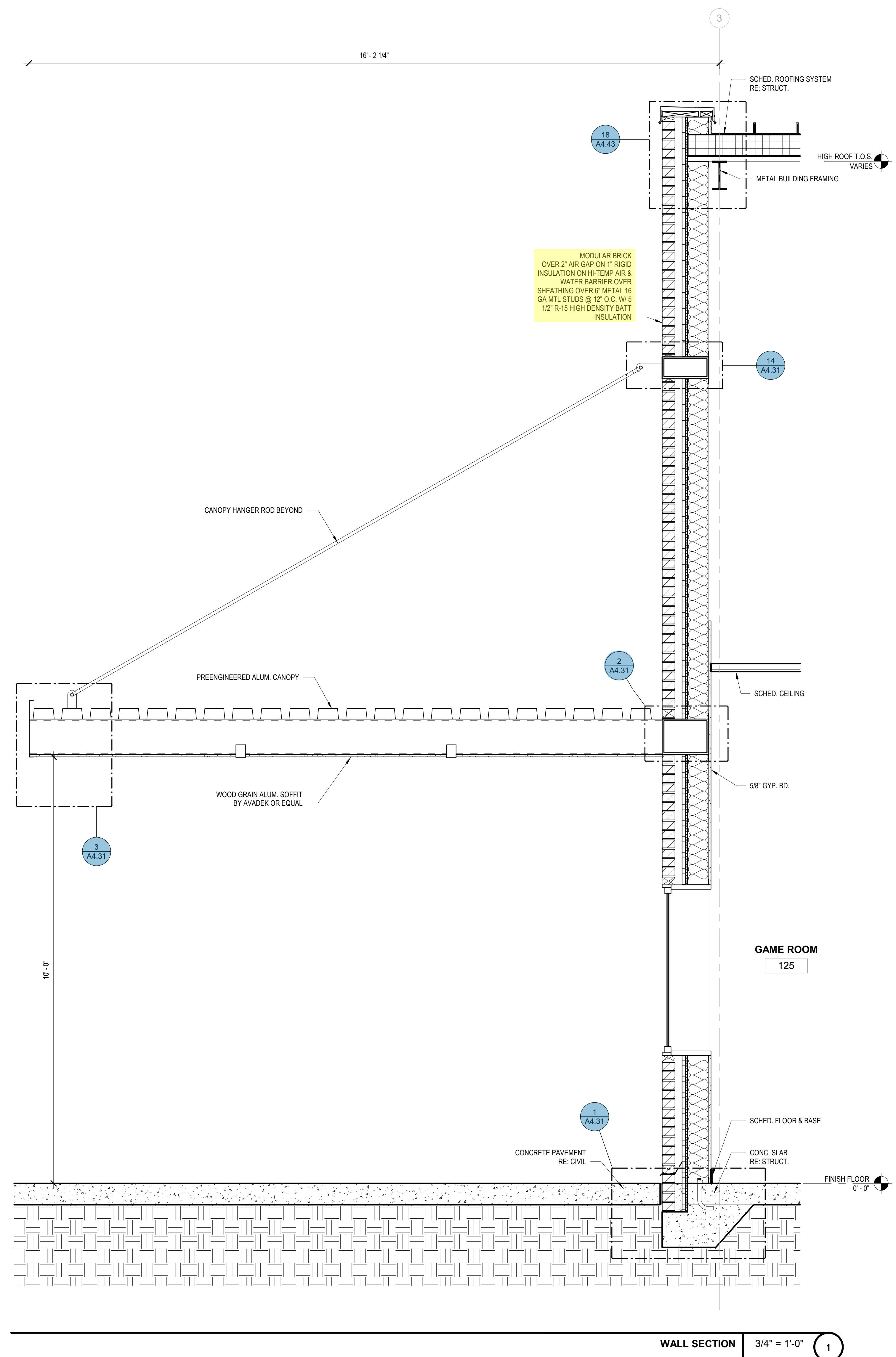
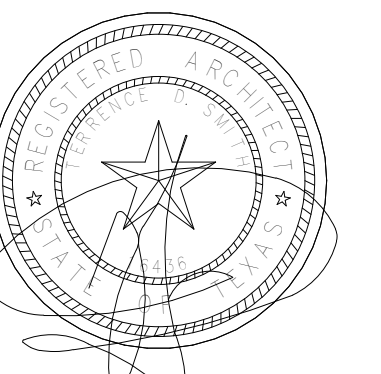

WALL SECTION 3/4" = 1'-0" 31

WALL SECTION 3/4" = 1'-0" 25

WALL SECTION 3/4" = 1'-0" 19

WALL SECTION 3/4" = 1'-0" 1

ARCHITECTURAL SUPPLEMENTAL INSTRUCTION NO. #10

DATE: May 6, 2025
PROJECT: Fresno Boys & Girls Club
LOCATION: 1031 W Sycamore Rd Fresno, Tx 77545
PROJECT NO. N032023
DISTRIBUTION: Ft Bend Procurement Department
DELIVERED VIA: Email
NO. PAGES: 3 pages
PREPARED BY: Smith & Company Architects, Inc



05/06/2025

This Architectural Supplemental Instruction (ASI) narrative is a part of the construction documents for Fort Bend County Precinct 2 for the Fresno Boys & Girls Club documents posted on February 29, 2024, for the subject project and modifies/add to them as noted below.

CHANGES TO DRAWINGS

DOCUMENTS

1. Delete Sheet A4.01 EXTERIOR ELEVATIONS dated August 30, 2024, and replace with A4.01 EXTERIOR ELEVATIONS revised May 6, 2025.
2. Delete Sheet A4.24 WALL SECTIONS dated August 30, 2024, and replace with A4.24 WALL SECTIONS revised May 6, 2025.

ARCHITECT
SMITH & COMPANY ARCHITECTS
720 N POST OAK, SUITE 124
HOUSTON, TX 77024

STRUCTURAL ENGINEER
STANLEY SPURLING & HAMILTON INC.
3301 EDGEMOOR ST.
HOUSTON, TX 77027

CIVIL ENGINEER
LJA ENGINEERING FRN F-1388
1504 W GRAND PARKWAY N, SUITE 100
KATY, TX 77459

LANDSCAPE ARCHITECT
STUDIO AVID
6046 FM 2920 RD, #280
SPRING, TX 77379

MEP ENGINEER
INFRASTRUCTURE ASSOCIATES
6117 RICHMOND AVE., SUITE 200
HOUSTON, TX 77057
TIRE FIRM REG.#-4506

TECHNOLOGY CONSULTANT
TRUE NORTH CONSULTANT GROUP
3408 HILLCREST DR.
WACO, TX 76708

PROJECT #: N032023
DATE ISSUED: 02.29.2024
TDLR #: TABS2024011699

REVISIONS:

NO.	DATE	DESCRIPTION
1	04.12.2024	Address #2
2	07.03.2024	ASI #1
3	08.30.2024	ASI #3
5	08.30.2024	ASI #3
17	05.05.2025	ASI #10

- 1 ALTERNATING BRICK VENEER: POPULAR GRAY AND SILVER CITY ACME BRICK COLORS WITH ROYAL UMBER MORTAR; REF: 6/A4.01
- 2 HIGH-PRESSURE LAMINATE PANELS: TRESPA METEON UNI COLORS; REF: 1/A4.02
- 3 SILVER METALLIC CORRUGATED METAL WALL PANELS: MBCI MASTERLINE 16
- 4 PROTECTIVE COVER REF: SPEC 107300
- 5 METAL SUNVISER: THEUT GLASS HORIZONTAL SUNSHADES B.O.D.
- 6 BRICK CONTROL JOINT
- 7 VERTICAL METAL SUNSHADES: THEUT GLASS CURTAIN WALL VERTICAL FINIS B.O.D.
- 8 BOARD FORMED CONCRETE; REF: LANDSCAPE
- 9 ALUM. DOWNSPOUT
- 10 ALUM. GUTTER
- 11 ALUM LOUVERS; REF: MECH.
- 12 CAST DEDICATION PLAQUE; REF: 18/G1.11

- 1 REFER TO A3.30 FOR WINDOW TYPES
- 2 REFER TO A1.00 FOR SITE PLAN NOTES

TYP. BRICK PATTERN 1 1/2" = 1'-0" 6

KEY NOTES NO SCALE 12

EXTERIOR ELEVATIONS GENERAL NOTES NO SCALE 6

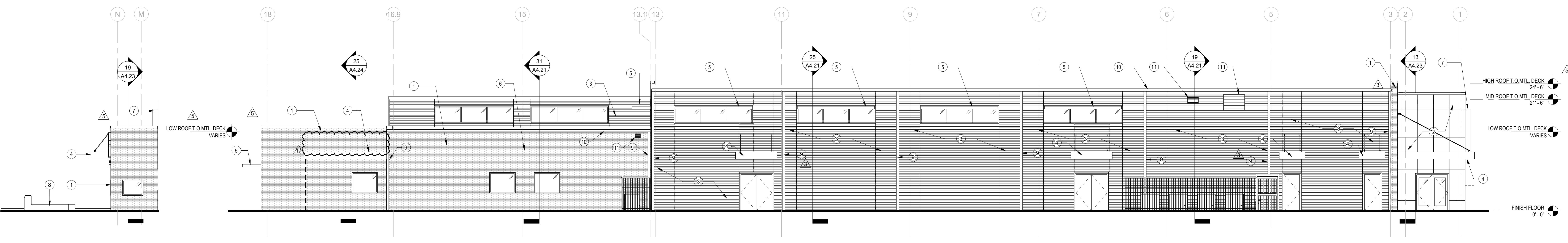

PARTIAL WEST ELEVATION 1/8" = 1'-0" 35

SOUTH ELEVATION 1/8" = 1'-0" 5

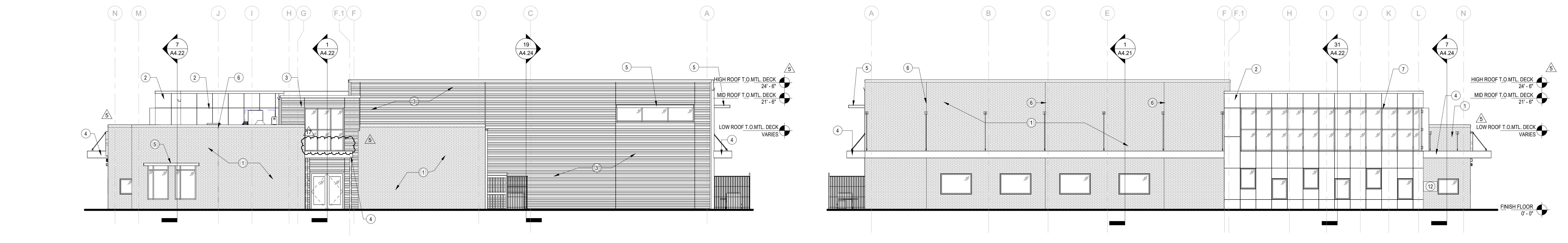

WEST ELEVATION 1/8" = 1'-0" 21

EAST ELEVATION 1/8" = 1'-0" 3

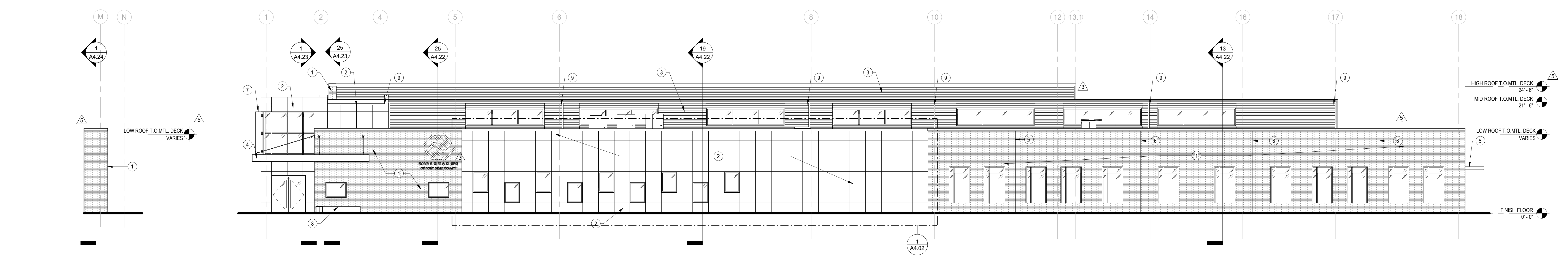

PARTIAL EAST ELEVATION NO SCALE 31

NORTH ELEVATION 1/8" = 1'-0" 1

FRESNO BOYS & GIRLS CLUB
1031 W SYCAMORE RD
FRESNO, TX 77545

EXTERIOR ELEVATIONS

100% Construction Document
02.29.2024

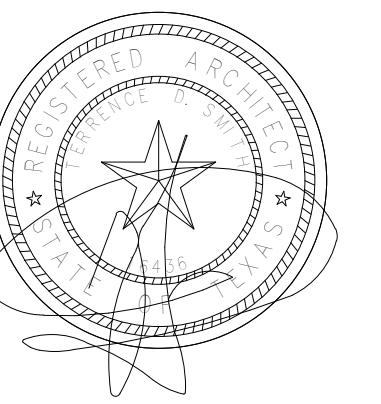

A4.01

ARCHITECT
SMITH & COMPANY ARCHITECTS
720 N POST OAK, SUITE 124
HOUSTON, TX 77024

STRUCTURAL ENGINEER
STANLEY SPURLING & HAMILTON INC.
3301 EDGEMOOR ST.
HOUSTON, TX 77027

CIVIL ENGINEER
LJA ENGINEERING FRN F-1386
1504 W GRAND PARKWAY N, SUITE 100
KATY, TX 77459

LANDSCAPE ARCHITECT
STUDIO AVID
6046 FM 2920 RD, #260
SPRING, TX 77379

MEP ENGINEER
INFRASTRUCTURE ASSOCIATES
6117 RICHMOND AVE., SUITE 200
HOUSTON, TX 77057
TIRE FIRM REG.#-4506

TECHNOLOGY CONSULTANT
TRUE NORTH CONSULTANT GROUP
3408 HILLCREST DR.
WACO, TX 76708

PROJECT #: N032023
DATE ISSUED: 02.29.2024
TDLR #: TABS2024011699

REVISIONS:

NO.	DATE	DESCRIPTION
5	08.30.2024	ASI #3
17	05.06.2025	ASI #10

FRESNO BOYS & GIRLS CLUB
1031 W SYCAMORE RD
FRESNO, TX 77545

WALL SECTIONS

100% Construction Document
02.29.2024

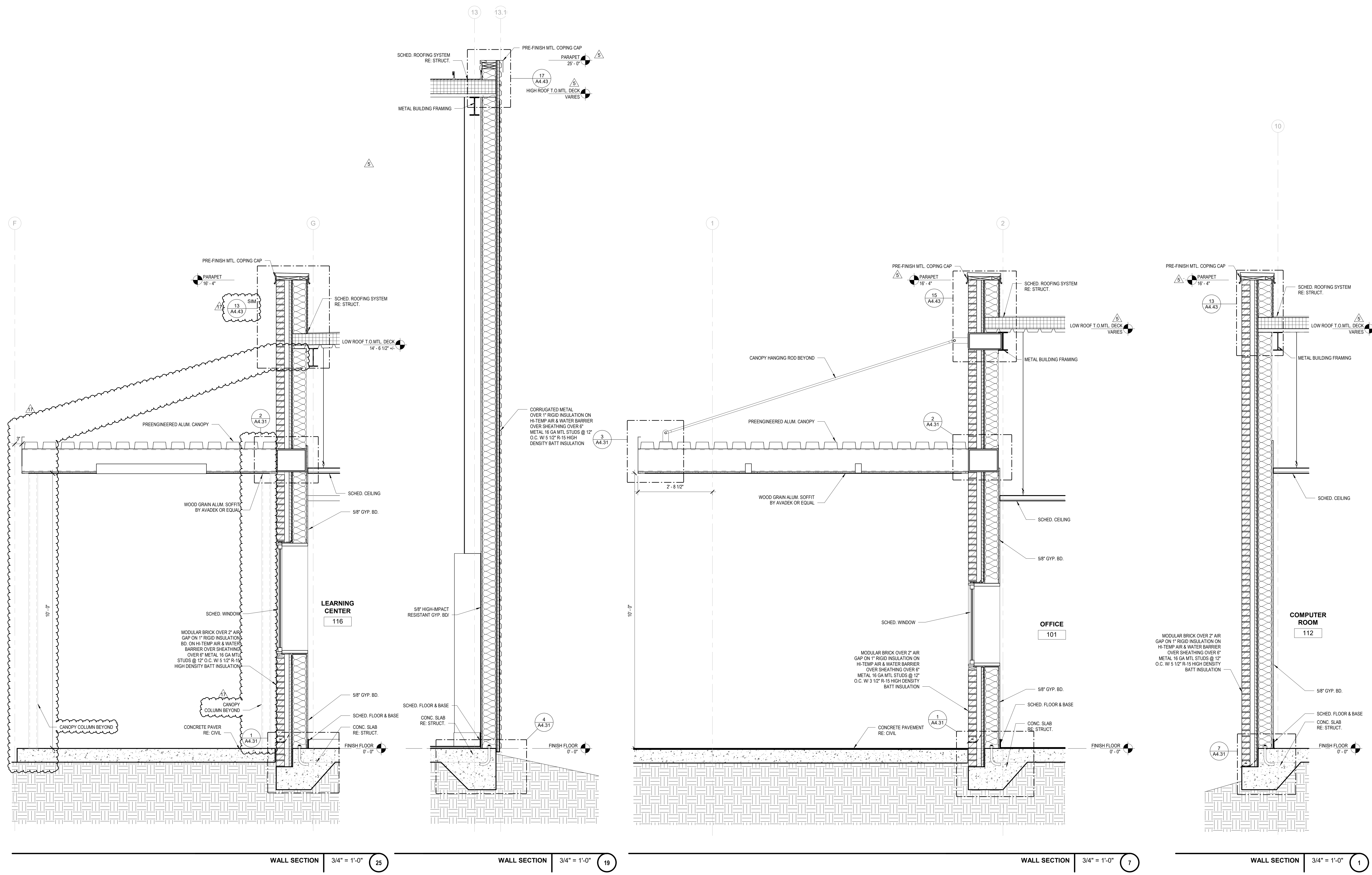
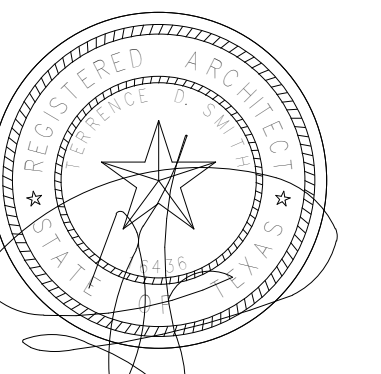

WALL SECTION 3/4" = 1'-0" 25

WALL SECTION 3/4" = 1'-0" 19

WALL SECTION 3/4" = 1'-0" 7

WALL SECTION 3/4" = 1'-0" 1



ADDITIONAL WORK AUTHORIZATION

K. C. SERVICES *Drywall Services*

~~10203 Pawnee Falls~~ *15235 Roadrunner*
Cyprees, TX 77429
(832) 643-7729
kcskelley@aol.com

DRYWALL

OWNER'S NAME <i>Teal</i>		PHONE	DATE <i>6-5-25</i>
STREET		JOB NAME <i>FRESNO BOYS & GIRLS</i>	JOB NUMBER
CITY	STATE	STREET	
EXISTING CONTRACT NO.	DATE OF EXISTING CONTRACT	CITY <i>FRESNO</i>	STATE <i>TX</i>

You are hereby authorized to perform the following specifically described additional work:

*DENSGLASS DESTROYED WENOT DEMOED
TO REMOVE WALL AT EXTERIOR*

25 Sheets

500.00

ADDITIONAL CHARGE FOR ABOVE WORK IS: \$ 500.00

Payment will be made as follows:

Above additional work to be performed under same conditions as specified in original contract unless otherwise stipulated.

Date _____ 20____ Authorizing Signature _____
(OWNER SIGNS HERE)

We hereby agree to furnish labor and materials - complete in accordance with the above specifications, at above stated price.

Authorized Signature _____ Date *6-5-25* 20____
(CONTRACTOR SIGNS HERE)

THIS IS CHANGE ORDER NO.

NOTE: This Revision becomes part of, and in conformance with, the existing contract.



ADDITIONAL WORK AUTHORIZATION

K. C. DRYWALL SERVICES

15235 BOUDREAUX Rd

Cyprees, TX 77429

(832) 643-7729

kcskelley@aol.com

DRYWALL

OWNER'S NAME <i>Teal</i>		PHONE	DATE <i>5-28-25</i>
STREET		JOB NAME <i>FRESNO BOY-GIRLS</i>	JOB NUMBER
CITY	STATE	STREET	
EXISTING CONTRACT NO.	DATE OF EXISTING CONTRACT	CITY <i>FRESNO</i>	STATE <i>TX</i>

You are hereby authorized to perform the following specifically described additional work:

*REINSTALL EXTERIOR WALL THAT
WERE DEMOED.*

EQUIPMENT

1700.00

LABOR

6500.00

ADDITIONAL CHARGE FOR ABOVE WORK IS: \$ 8200.00

Payment will be made as follows: _____

Above additional work to be performed under same conditions as specified in original contract unless otherwise stipulated.

Date _____ 20____ Authorizing Signature _____
(OWNER SIGNS HERE)

We hereby agree to furnish labor and materials - complete in accordance with the above specifications, at above stated price.

Authorized Signature *Dem Kelley* Date *5-28* 20*25*
(CONTRACTOR SIGNS HERE)

THIS IS CHANGE ORDER NO. _____

NOTE: This Revision becomes part of, and in conformance with, the existing contract.



ADDITIONAL WORK AUTHORIZATION

K. C. DRYWALL SERVICES

15235 Boudreaux Rd

Cyprees, TX 77429

(832) 643-7729

kcskelley@aol.com

DRYWALL

OWNER'S NAME <i>Texe</i>		PHONE	DATE <i>5-2-25</i>
STREET		JOB NAME <i>FRESNO BOYS & GIRLS</i>	JOB NUMBER
CITY	STATE	STREET	
EXISTING CONTRACT NO.	DATE OF EXISTING CONTRACT	CITY	STATE

You are hereby authorized to perform the following specifically described additional work:

Demol EXTERIORS FOR STEEL MOVEMENT

EQUIPMENT:

1,500.00

7OLF OF TWO RUNS OF STUDS

DEGLASS

3,000.00

4OLF OF STUDS & DEGLASS

1,000.00

ADDITIONAL CHARGE FOR ABOVE WORK IS: \$ *5,500.00*

Payment will be made as follows: _____

Above additional work to be performed under same conditions as specified in original contract unless otherwise stipulated.

Date _____ 20____ Authorizing Signature _____
(OWNER SIGNS HERE)

We hereby agree to furnish labor and materials - complete in accordance with the above specifications, at above stated price.

Authorized Signature _____ Date *5-2* 20*25*
(CONTRACTOR SIGNS HERE)

THIS IS CHANGE ORDER NO. _____

NOTE: This Revision becomes part of, and in conformance with, the existing contract.

CHANGE ORDER QUOTE # 14777

QUOTE DATE: Thursday, May 29, 2025

CUSTOMER NAME: Teal Construction

JOB NUMBER & NAME: 24252 Fresno Boys and Girls Club

CUSTOMER CONTACT: Michael Krause

RED DOT CONTACT: Justin Flatt

PROJECT TYPE: Erected

RED DOT to:

1. Provide and install (28) red oxide primed canopy support brackets per attached sketch.

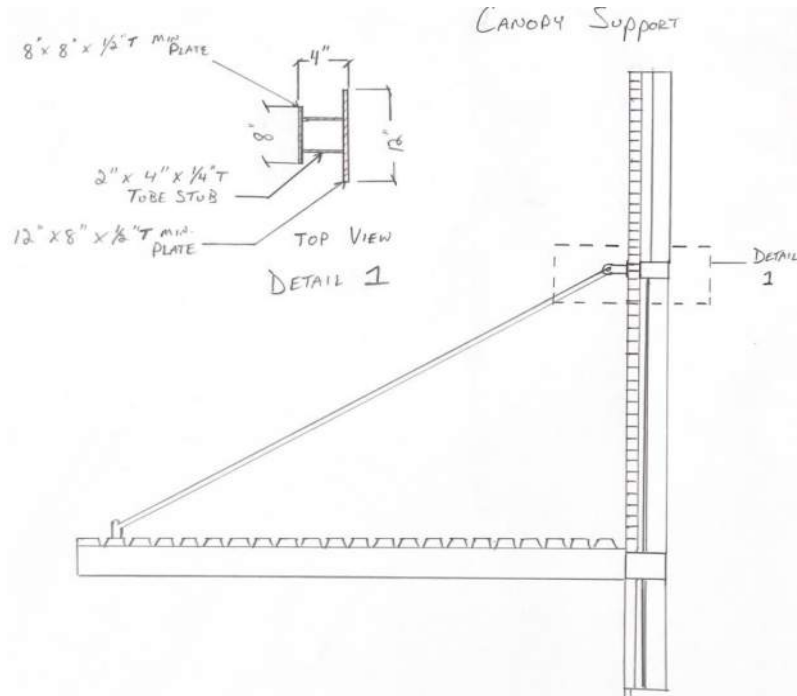

NOTE: Includes Material, Freight and Labor

Cost of Changes: \$15,319

Acceptance and authorization of this COQ is required within 10 business days of receiving unless noted otherwise to ensure costs are not affected. If Red Dot is erecting this project and the erector has demobilized before Red Dot is able to fabricate and deliver materials to the job site, additional erection labor will be added to the CO amount.

Red Dot reserves the right to alter this contract price to offset significant steel cost increases imposed upon the metal building industry.

Please authorize by signing below and return to Red Dot via the sender's email.

RED DOT BUILDINGS REPRESENTATIVE

CUSTOMER REPRESENTATIVE

Signature/ Date

Signature/ Date

Printed

Pricing: BAL

Printed

Reviewed: BAL

Approved: BAL

CHANGE ORDER QUOTE # 14655

QUOTE DATE: Tuesday, May 20, 2025

CUSTOMER NAME: Teal Construction

JOB NUMBER & NAME: 24252 Fresno Boys and Girls Club

CUSTOMER CONTACT: Michael Krause

RED DOT CONTACT: Justin Flatt

PROJECT TYPE: Erected

RED DOT to:

1. Provide and install material to shorten tube spandrels at GL G to be 16'-11" from GL 17 towards GL 18.

NOTE: Includes Material, Freight and Labor

Cost of Changes: \$15,792

Acceptance and authorization of this COQ is required within 10 business days of receiving unless noted otherwise to ensure costs are not affected. If Red Dot is erecting this project and the erector has demobilized before Red Dot is able to fabricate and deliver materials to the job site, additional erection labor will be added to the CO amount.

Red Dot reserves the right to alter this contract price to offset significant steel cost increases imposed upon the metal building industry.

Please authorize by signing below and return to Red Dot via the sender's email.

RED DOT BUILDINGS REPRESENTATIVE

CUSTOMER REPRESENTATIVE

Signature/ Date

Signature/ Date

Printed

Pricing: AS

Printed

Reviewed: BAL

Approved: BAL

email 052325 2:35



INVOICE

6035 Brookfield Dr.
Houston, TX 77085

P: (713) 729-8759

E-mail: vitalsteelerectors@yahoo.com

RCVD BY

05/27/2025

ACCOUNTING

DATE	5/23/2025
INVOICE #	1

TO

Michael Krause
Teal Construction Co.
1335 Brittmoore Rd.
Houston, TX 77043
Phone: 713.465.8306

E-mail: michaelkrause@tealcon.com

PROJECT INFORMATION	
JOB NO:	VSE 1772
PO NO:	
JOB NAME:	Boys & Girls Club
JOB ADDRESS:	1030 W Sycamore Rd.
	Fresno, TX 77545

Description	Amount
Modify Canopy Top Tube	\$ 13,990.00
Total	
	\$ 13,990.00

If you have any questions concerning this invoice, contact:
Norma Amezcuita | 713.729.8759 | norma@vitalsteelerectors.com

THANK YOU FOR YOUR BUSINESS!



Fort Bend County Fresno Boys & Girls Club
 1031 W Sycamore Rd Fresno Tx

Change Order

Change Order
No. 005

Changes in AV Scope

RE: **Mineral Wool @ Trespa Panels**
 Date: 7/9/2025

Teal Job #24-1707

Item #	Description	Total	Contractor
1	Changes in AV Scope	-\$22,013.00	Genesis
2	Furnish & Install 16" Mineral Wool behind Trespa Panels	\$24,000.00	3E Contracting
	Subcontractor Subtotal	\$1,987.00	
Project Schedule - Impacts/Delays			
	Current Substantial Completion Date:	6/15/2025	No. of Days of Schedule Impact: 62 Days
			Revised Substantial Completion: 9/3/2025
Summary			
		Sub Total	\$1,987.00
		Project Schedule Days Added (Calendar)	0
		General Conditions (5%)	\$99.35
		Insurance (3%)	\$59.61
		Fee (5%)	\$99.35
		Grand Total	\$2,245.31
		Date:	7/9/2025
	Michael Krause - PM - Teal Construction		



**Fort Bend County IT Building
FACILITIES PLANNING AND CONSTRUCTION**

CHANGE PROPOSAL

Teal Construction

Genesis Cabling Solutions	1
Company Name	Change Proposal No.
	Fresno Community Center
Address	Project Name
6/11/2025	Credit for over Bid
Date	Work Changes Proposal Request No.
NA	
Architect	

THE BREAKDOWN OF PROPOSED COSTS FOR: WORK CHANGES PROPOSAL REQUEST # _____ IS AS FOLLOWS:

A. For self-performed work:

1. Cost of Materials & Supplies	\$	-	
2. Cost of Equipment	\$	-	
3. Cost of Labor <i>(including Burden, see Cost Analysis Form)</i>	\$	(2,160)	
4. Subtotal	\$	(2,160)	
5. Overhead 15%	\$	-	
6. Subtotal			\$ (2,160)
7. Profit 10%	\$	-	
8. Credit back	\$	(19,853)	
9. Bond (if applicable)			\$ -
TOTAL VALUE OF PROPOSAL			\$ (22,013)

C. Total HUB percentage for this Change Proposal is _____ 100%

Ricardo Molina
Signature (Subcontractor)



5/27/2025

RE: Updated Mineral wool pricing

3E Contracting proposes to furnish all labor, equipment, material and supervision and the proper insurance to perform the following services at the above referenced location.

Mineral wool.

- Our supplier reached out ensure that the material had foil facer as spec'd and was notified the minimum order quantity is 7000 sf which is more than double what we need.

\$24,000.00 Total

** Mineral wool product is made to order so the minimum lead time would be approx. 1 month. Energy shield lead time is 1-2 weeks.

Material price along with long lead time I think the Energy shield product is the better option. The Energy shield is a foil faced material and has better R value than the mineral wool

If you have any questions regarding the above information, please give me a call at 832-585-9093

Sincerely,

Jonathan Davenport

Authorization of Building Owner or Representative

Date



Fort Bend County Fresno Boys & Girls Club
1031 W Sycamore Rd Fresno Tx

Change Order

Change Order
No. 006

RE: **Weather Delays to the Project**
Date: 8/21/2025

Teal Job #24-1707

Item #	Description	Total	Contractor
1	(4) Months of General Conditions Billed at \$28,000 per month (116 days incurred on the project)	\$112,000.00	Teal Construction
2	(1) Month of General Conditions Paid via CO 002 (62 days recorded in CO 002)	-\$28,000.00	Teal Construction
	Subcontractor Subtotal	\$84,000.00	
Project Schedule - Impacts/Delays			
	Current Substantial Completion Date:	6/15/2025	No. of Days of Schedule Impact: 116 Days
			Revised Substantial Completion: 10/27/2025
Summary			
		Sub Total	\$84,000.00
		Project Schedule Days Added (Calendar)	0
		General Conditions (5%)	\$4,200.00
		Insurance (3%)	\$2,520.00
		Fee (5%)	\$4,200.00
		Grand Total	\$94,920.00
		Date:	8/21/2025
	Michael Krause - PM - Teal Construction		



Fort Bend County Fresno Boys & Girls Club
1031 W Sycamore Rd Fresno Tx

Change Order

Change Order
No. 007

RE: **Condensor Supporting Steel**
Date: 10/6/2025

Teal Job #24-1707

Item #	Description	Total	Contractor
1	Furnish & Install Steel Supports for HVAC Condensers	\$22,167.00	Red Dot
2	Work to Roof to Install Steel Supports (ESTIMATED)		Diverse Roofing
	Subcontractor Subtotal	\$22,167.00	
	Project Schedule - Impacts/Delays	0	
	Current Substantial Completion Date:	6/15/2025	No. of Days of Schedule Impact: 116 Days
			Revised Substantial Completion: 10/27/2025
	Summary		
		Sub Total	\$22,167.00
		Project Schedule Days Added (Calendar)	0
		General Conditions (5%)	\$1,108.35
		Insurance (3%)	\$665.01
		Fee (5%)	\$1,108.35
		Grand Total	\$25,048.71
		Date:	10/6/2025
	Michael Krause - PM - Teal Construction		

CHANGE ORDER QUOTE # 15492

QUOTE DATE: Friday, August 29, 2025

CUSTOMER NAME: Teal Construction

JOB NUMBER & NAME: 24252 Fresno Boys and Girls Club

CUSTOMER CONTACT: Michael Krause

RED DOT CONTACT: Justin Flatt

PROJECT TYPE: Erected

RED DOT to:

1. Provide and install additional galvanized steel support (W Beam and Pipe) per the attached sketch to support additional equipment to be placed on the roof. Located along GL I between FLs 6 & 7.
Weights of units as follows:

- (1) at 389#
- (1) at 516#
- (1) at 731#

NOTE: Includes Material, Freight, Labor and Equipment

Cost of Changes: \$22,167

Acceptance and authorization of this COQ is required within 10 business days of receiving unless noted otherwise to ensure costs are not affected. If Red Dot is erecting this project and the erector has demobilized before Red Dot is able to fabricate and deliver materials to the job site, additional erection labor will be added to the CO amount.

Red Dot reserves the right to alter this contract price to offset significant steel cost increases imposed upon the metal building industry.

Please authorize by signing below and return to Red Dot via the sender's email.

RED DOT BUILDINGS REPRESENTATIVE

CUSTOMER REPRESENTATIVE

Signature/ Date

Signature/ Date

Printed

Pricing: BAL

Printed

Reviewed: BAL

Approved: Select from M

Member Table	Quan	Mark	Part
1	E-1	10.0LESD14	
1	E-2	8.12HESD14	
1	E-3	8.0LESD14	
1	E-4	10.12HESD14	
1	E-5	10.0LESD14	
1	E-6	10.12HESD12	
1	E-7	8.0LESD14	
1	E-8	8.12HESD14	
1	E-9	10.12HESD14	
1	E-10	10.12HESD12	
1	E-11	10.0LESD14	
1	E-12	8.12HESD14	
1	E-14	8.0LESD14	
1	E-15	8.0LESD14	
1	E-16	10.12HESD14	
1	E-18	10.12HESD14	
1	E-19	8.0LESD14	
1	E-20	8.0LESD14	
1	E-21	10.12HESD14	
1	E-24	10.12HESD14	
1	E-27	10.12HESD14	
1	E-28	10.12HESD14	
1	E-30	8.0LESD14	
1	E-31	8.0LESD14	
1	E-32	8.0LESD14	
1	E-33	10.12HESD14	
1	E-34	8.0LESD14	
1	P-2	8X25Z14	
1	P-12	10X35Z14	
1	P-27	8X25Z16	
1	P-32	8X25Z12	
1	P-36	10X35Z14	
1	P-37	10X35Z14	
1	P-38	10X35Z14	
1	P-41	10X35Z14	
1	P-42	10X35Z14	
1	P-43	10X35Z14	
1	P-46	8X25Z16	
1	P-49	8X25Z16	
1	P-50	8X25Z16	
1	P-52	8X25Z16	
2	E-9	10.12HESD14	
2	E-13	8.0LESD14	
2	E-17	8.0LESD14	
2	E-22	8.0LESD14	
2	E-25	8.0LESD14	
2	P-1	10X35Z12	
2	P-30	10X35Z14	
2	P-33	10X35Z14	
2	P-34	10X35Z14	
2	P-44	8X25Z16	
3	P-3	10X35Z12	
3	P-4	10X35Z12	
3	P-7	10X35Z14	
3	P-14	8X25Z14	
3	P-17	8X25Z14	
3	P-21	8X25Z14	
3	P-22	8X25Z16	
3	P-25	8X25Z14	
3	P-28	8X25Z16	
3	P-29	10X35Z14	
3	P-35	8X25Z16	
3	P-45	8X25Z16	
3	P-9	10X25Z12	
5	P-11	10X25Z12	
5	P-15	10X35Z14	
5	P-18	10X35Z14	
5	P-19	10X35Z14	
5	P-26	10X35Z14	
6	P-47	8X25Z16	
14	P-39	8X25Z12	
14	P-51	8X25Z12	
15	P-6	10X35Z14	
15	P-13	8X25Z12	
15	P-16	8X25Z12	
15	P-20	8X25Z12	
15	P-24	8X25Z12	

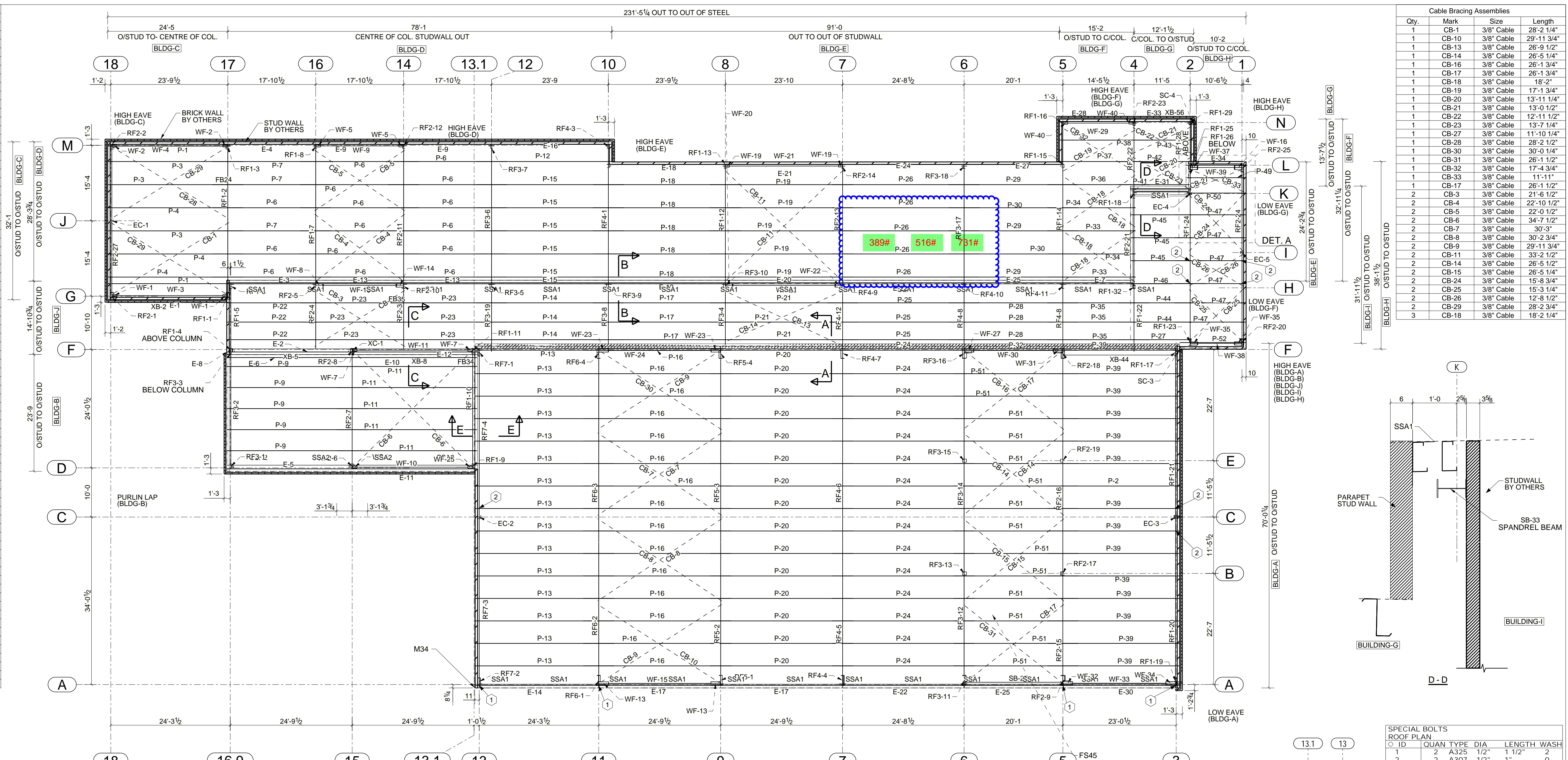

Qty.	Mark	Size	Length
1	CB-10	3/8" Cable	28'-2 1/4"
1	CB-13	3/8" Cable	29'-11 3/4"
1	CB-14	3/8" Cable	26'-9 1/2"
1	CB-16	3/8" Cable	26'-5 1/4"
1	CB-17	3/8" Cable	26'-1 3/4"
1	CB-18	3/8" Cable	18'-2"
1	CB-19	3/8" Cable	17'-1 3/4"
1	CB-21	3/8" Cable	13'-11 1/4"
1	CB-22	3/8" Cable	13'-0 1/2"
1	CB-23	3/8" Cable	12'-11 1/2"
1	CB-28	3/8" Cable	11'-0 1/4"
1	CB-30	3/8" Cable	30'-0 1/4"
1	CB-31	3/8" Cable	26'-1 1/2"
1	CB-32	3/8" Cable	17'-4 3/4"
1	CB-33	3/8" Cable	11'-11"
1	CB-37	3/8" Cable	16'-7 1/2"
2	CB-3	3/8" Cable	21'-6 1/2"
2	CB-4	3/8" Cable	22'-0 1/2"
2	CB-5	3/8" Cable	22'-0 1/2"
2	CB-6	3/8" Cable	34'-7 1/2"
2	CB-7	3/8" Cable	30'-3"
2	CB-8	3/8" Cable	30'-2 3/4"
2	CB-9	3/8" Cable	29'-11 3/4"
2	CB-11	3/8" Cable	33'-2 1/2"
2	CB-12	3/8" Cable	26'-5 1/2"
2	CB-15	3/8" Cable	26'-5 1/4"
2	CB-24	3/8" Cable	15'-8 3/4"
2	CB-25	3/8" Cable	15'-3 1/4"
2	CB-26	3/8" Cable	12'-8 1/2"
2	CB-29	3/8" Cable	28'-2 3/4"
3	CB-18	3/8" Cable	18'-2 1/4"

THIS PROJECT SHALL BE ERRECTED PER THE AISC 303-05 SPECIFICATION, CODE OF STANDARD PRACTICE FOR STEEL BUILDING AND BRIDGES, AND CHAPTER M OF AISC 360-05. SPECIFICATIONS FOR STRUCTURAL STEEL BUILDINGS. SPECIAL ATTENTION IS NOTED FOR SECTION 7.14 IN THE AISC 303-05 SPECIFICATION AND STATED BELOW:

"THE CORRECTION OF MINOR MISFITS BY SEPARATE AMOUNTS OF REAMING, GRINDING, WELDING OR CUTTING, AND THE DRAWING OF ELEMENTS INTO LINE WITH DRIFT PINS, SHALL BE CONSIDERED TO BE NORMAL ERECTION OPERATIONS. ERRORS THAT CAN NOT BE CORRECTED USING THE FOREGOING MEANS, OR THAT REQUIRE MAJOR CHANGES IN MEMBER OR CONNECTION CONFIGURATION, SHALL BE PROMPTLY REPORTED TO THE OWNER'S DESIGNATED REPRESENTATIVES FOR DESIGN AND CONSTRUCTION AND THE FABRICATOR BY THE ERECTOR, TO ENABLE THE RESPONSIBLE ENTITY TO EITHER CORRECT THE ERROR OR APPROVE THE MOST EFFICIENT AND ECONOMICAL METHOD OF CORRECTION TO BE USED BY OTHERS"

NO BACKCHARGES WILL BE ACCEPTED UNLESS APPROVED IN WRITING BY THIS OFFICE.

NOTE: ALL LIGHT GAUGE CONN. BOLTS ARE 1/2" Ø x 1" A307 U.N. ALL BEARING FRAME ENDWALL CONN. BOLTS ARE 3/4" x 1 1/2" A307 U.N. ALL BEARING SIZE AND QTY. REQUIREMENTS AT OTHER CONNECTIONS, SEE PLANS. DETERMINED BY MEASURING THE THICKNESS OF CONN. PLATES AND ADDING THE APPROPRIATE AMOUNT (SEE CHART) THEN ROUND UP TO THE NEXT 1/4" TO GET THE EXACT BOLT LENGTH. IF WASHERS ARE REQUIRED, ADD 3/16" FOR FLAT WASHERS AND 5/16" FOR BEVELLED WASHERS TO ABOVE BEFORE ADDING APPROPRIATE AMOUNT FROM CHART.

BOLT SIZE	ADD
5/8"	7/8"
3/4"	1"
7/8"	1 1/8"
1"	1 1/4"
1 1/8"	1 1/2"

ROOF FRAMING PLAN

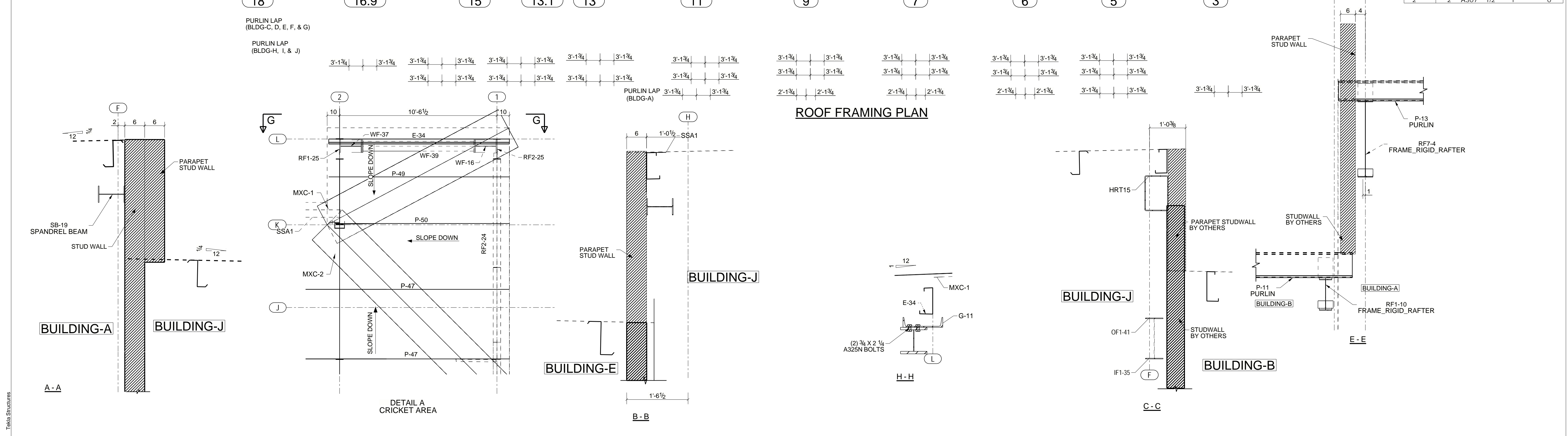

This seal pertains only to the materials designed and supplied by Red Dot and does not serve or represent the project Engineer of record or as the registered design professional in responsible charge for the overall project and shall not be construed as such. This document is released under the authority of Red Dot engineer on the date signed and sealed below, for the sole purpose of construction.

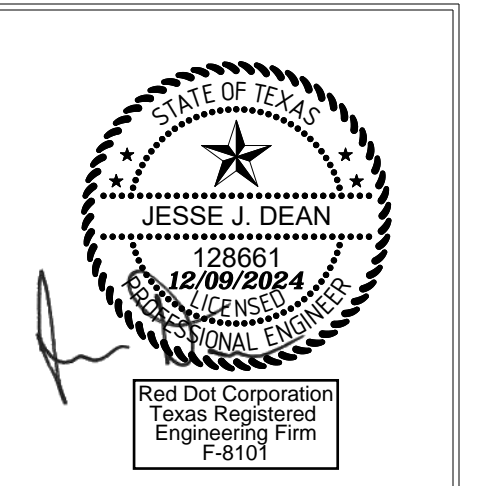

THIS DRAWING AND ITS CONTENTS ARE THE PROPERTY OF RED DOT BUILDINGS AND ARE CONSIDERED CONFIDENTIAL. THEY MAY NOT BE COPIED OR REPRODUCED WITHOUT EXPRESSED WRITTEN CONSENT OF RED DOT BUILDINGS

ISSUE	DESCRIPTION	DATE
A/P	APPROVAL / PERMIT	07/30/2024
0	FOR CONSTRUCTION	10/15/2024



1209 W Corsicana St
Athens, TX
(903) 675-9181
(800) 657-2234
WWW.REDDOTBUILDINGS.COM

CUSTOMER: Teal Construction Company
LOCATION: Fresno TX
DRAWING TITLE: ROOF FRAMING PLAN
BUILDING DESCRIPTION: Fresno Boys & Girls Club
DRAWN BY: MT-KHS DATE: 07/27/2024 DESIGNER: SJ*** SALESMAN: JF
CHECKED BY: QCLH DATE: 10/16/2024 SCALE: NONE ISSUE: 0
JOB NUMBER: 24252 SHEET NUMBER: E1 of E75



Fort Bend County Fresno Boys & Girls Club
1031 W Sycamore Rd Fresno Tx

Change Order

Change Order
No. 008

RE: **Warming Kitchen 3-Basin Sink**
Date: **9/9/2025**

Teal Job #24-1707

Item #	Description	Total	Contractor
1	Kitchen Appliances Allowance	-\$2,000.00	
2	CO #8- Warming Kitchen 3-Basin Sink	\$14,362.00	
	Subcontractor Subtotal	\$12,362.00	
	Project Schedule - Impacts/Delays	0	
	Current Substantial Completion Date:	6/15/2025	No. of Days of Schedule Impact: 116 Days
			Revised Substantial Completion: 10/27/2025
	Summary		
		Sub Total	\$12,362.00
		Project Schedule Days Added (Calendar)	0
		General Conditions (5%)	\$618.10
		Insurance (3%)	\$370.86
		Fee (5%)	\$618.10
		Grand Total	\$13,969.06
		Date:	9/9/2025
	Michael Krause - PM - Teal Construction		

Menu

0

What are you looking for?



plus FREE Trial Available! Unlock Free Shipping > **plus** Earn 3% Back* & Save on Plus >

[WebstaurantStore](#) > [Restaurant Equipment](#) > [Commercial Sinks](#) > [Sink Bowls](#) > Advance Tabco DI-3-1410 3 Compartment Drop-In Sink - 16" x 14" x 10" Bowls

Advance Tabco DI-3-1410 3 Compartment Drop-In Sink - 16" x 14" x 10" Bowls

Item #: 109DI31410 MFR #: DI-3-1410

[Leave a review](#) | [2 answered questions](#)



\$1,770.46

4 interest-free payments of **\$442.62** [Apply Now >](#)

Credit Key

Ships free with **plus**

[Login](#) for details

1

Earn up to **\$53.11** back (5,311 points) with a [Webstaurant Rewards Visa® Credit Card](#)

Usually Ships in **2-4 Weeks** from manufacturer
Lead times vary based on manufacturer stock

Product Overview

- ✓ Seamless deep drawn sink bowls with rounded corners for easy cleaning

- ✓ Innovative self rim design allows flush mounting into any countertop
- ✓ 16" x 14" x 10" bowls
- ✓ 18 gauge, type 304 stainless steel
- ✓ 2 deck mounted swing spout faucets included

UPC Code:

747545117137



[View all Advance Tabco Sink Bowls](#)

Works With

plus  Advance Tabco K-455B Stainless Steel Sink Cover
\$326.50/Each

1 Add to Cart

plus  Advance Tabco K-610B 14" x 16" Strainer Plate
\$503.69/Each

1 Add to Cart

Advance Tabco DI-3-1410 Details

This Advance Tabco DI-3-1410 three compartment drop-in sink features a deep drawn one-piece bowl design and (3) 16" x 14" x 10" bowls, making it perfect for washing, rinsing, and sanitizing dishes in your commercial kitchen! The one-piece, seamless bowl design has rounded 2" radius corners that not only look great, but are easy to keep clean. The 8" deck mounted swing spout provides a steady stream of water and the 1 1/2" drain baskets prevent clogged drains.

The advantage of a drop-in sink design is that it allows for a quick and easy installation. Once an appropriately sized cut-out is made in your countertop surface, the sink is simply inserted into the opening. The included mounting clips secure the sink to the counter, and silicone or caulk should be applied around the lip of the sink. With your drain in place and water pipe connected, your sink will be ready for operation!

Made of 18 gauge type 304 stainless steel, this two compartment drop-in sink is a versatile, durable solution for any need. The bowls are provided with sound deadening pads to minimize the sound of dripping water against the stainless steel. In addition to that, this unit is finished off with the satin-look Smart Finish for a smooth, clean appearance that is also hardwearing and long-lasting. This sink is NSF Approved only when used in mobile food carts and kiosks.

Overall Dimensions:

- Left to Right: 50"
- Front to Back: 21"
- Height: 10"

Compartment Dimensions:

- Left to Right: 14"
- Front to Back: 16"
- Depth: 10"

Because this item is not stocked in our warehouse, processing, transit times and stock availability will vary. If you need your items by a certain date, please contact us prior to placing your order. Expedited shipping availability may vary. We cannot guarantee that this

item can be cancelled off of the order or returned once it is placed.



Advance Tabco: All of Your Ghost Kitchen Needs

[About](#)
[Transcript](#)
[Embed](#)

Advance Tabco's stainless steel restaurant equipment is built to meet the needs of any ghost kitchen. Learn more about this versatile line of equipment by watching this video!

Advance Tabco DI-3-1410 Specs	
Quantity	1/Each
Shipping Weight	48.18 lb.
Length	50 Inches
Width	21 Inches
Height	10 Inches
Cutout Length	49 1/4 Inches
Cutout Width	20 1/4 Inches
Bowl Depth	10 Inches
Basket Drain Size	3 1/2 Inches
Bowl Front to Back	16 Inches
Bowl Left to Right	14 Inches
Color	Silver
Corner Radius	2 Inches
Edge Style	Flush
Faucet Centers	4 Inches
Features	Made in America NSF Listed
Flow Rate	1 GPM
Gauge	18 Gauge

Included	Faucet
Installation Type	Drop-In
Material	Stainless Steel
Number of Compartments	3 Compartments
Stainless Steel Type	Type 304
Type	Drop-In Sinks

⚠ Attention CA Residents: Prop 65 Warning >



NSF Listed

This item has been certified by NSF International to meet applicable product standards on public safety, health, and / or the environment.



Best in Class

This product was given a Best in Class Award in Foodservice as chosen by foodservice operators, dealers, and consultants.



Made in America

This item was made in the United States of America.

Questions & Answers

Looking For Specific Info?

Get quick answers to product questions with our AI-powered search.



Ask about this product

Ask

By using this AI-powered search, you agree to our [Terms of Use](#) and [Privacy Policy](#).

Frequently Asked Questions From Customers

Is this drop-in sink NSF Approved for my restaurant? ^

Multi-compartment drop-in sinks are only NSF Approved when used in mobile food carts and kiosks. We recommend checking with your inspector prior to installation to verify that this sink will be permissible in your restaurant.

What cutout do I need for my sink? v



Need Parts & Accessories?

Show replacement parts and accessories for Advance Tabco DI-3-1410 today!

Find Parts for this Item

Resources and Downloads for Advance Tabco DI-3-1410



Specsheet

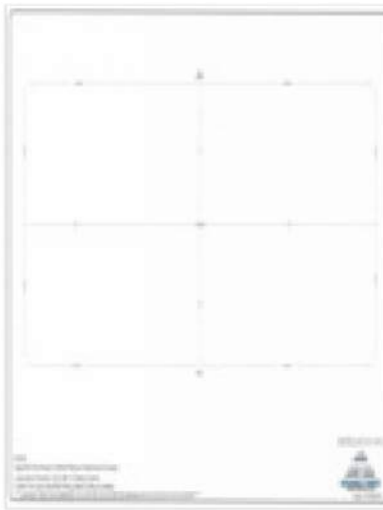

Instructions



Instructions







Warranty

A PDF viewer is required to view this product's information. [Download Adobe Acrobat software](#)

Resources

[How to Clean Stainless Steel](#)

Related Items

 <p>Sink Bowls</p> <p>497 Products</p>	 <p>Commercial Bathroom Sinks</p> <p>97 Products</p>	 <p>Hand Sinks and Accessories</p> <p>1017 Products</p>	 <p>Medical Sinks</p> <p>75 Products</p>	
--	--	---	--	--

Leave a review of this product!

If you've used this product, leave a review to tell us and other customers what you thought about it. Receive up to \$16 in promotional credits for submitting one of the first text, photo, or video reviews for this item.



Write a text review
Earn \$2.00



Post a product photo
Earn \$4.00



Post a product video
Earn \$10.00

Login or Register

Find Related Products

16 inch frying pan

3 compartment sink faucet

extra large serving bowls

food prep sink

three compartment plates

walk in cooler shelving racks

Enter your email to get latest deals & more!

Sign Up



Unlock Savings with FREE Shipping

No commitment, cancel at anytime.

[Start saving with Plus](#)



WebstaurantStore App

It's faster & easier in the app.

[Learn more about our App](#)



As the largest online restaurant supply store, we offer the best selection, best prices, and fast shipping to keep your business functioning at its best.

Services

Resources

About

Get Quick Help

Help Center

Track my Order

Chat Online

Shipping & Delivery

[Terms of Sale](#)

[Privacy Policy](#)

[Terms of Use](#)

[Accessibility Policy](#)

[Do Not Sell or Share My Personal Information](#)

© 2025 The WEBstaurant Store, LLC - All Rights Reserved.

Project:
 B07426A - FORT BEND COUNTY -
 EAGLE - FORT BEND TX -
 8/21/2025

From:
 Mission Restaurant Supply -
 Corporate
 Jacob Vasquez
 PO Box 10310
 San Antonio, TX 78210
 210-354-0690
 832-418-0243 (Contact)

Job Reference Number: B07426A

Quote Valid Until 9/21/2025
 Lead Time: TBD
 Drop Ship with liftgate

Item	Qty	Description	Sell	Sell Total
REV A - MODIFIED ITEM #'S 1 AND 1 ALT PER EMAIL REQUEST 8/19/25.				
1	1 ea	SINK, (3) THREE COMPARTMENT Eagle Group Model No. SPECFAB Flush Front Sink, three compartment, 110"W x 31"D, 15"W x 26" front-to-back x 15" deep bowls with twist brackets and overflow holes, hose bib bracket (hose and spray provided by others), drainboards on left & right, 10"H backsplash, (2) sets of splash mount faucet holes with 8" centers, includes (3) 3-1/2" basket drains, 14/3 stainless steel construction, stainless steel legs, cross rails, & front flanged feet, adjustable bullet feet, NSF Pot Rack, cantilever mount, 110"W x 20"D, single-bar design with tubular supports, constructed of 1/4" x 2" stainless steel flat bar, includes (24) double-pronged pot hooks, (1) 110"W x 12"D stainless steel shelf, NSF Shelf, cantilever mounted, 110"W x 12"D, rolled front edge, 1- 1/2"H up-turn on sides & rear, includes stainless steel mounting brackets stud welded to shelf, 16/304 stainless steel construction, NSF	\$11,288.00	\$11,288.00
	2 ea	301003 Faucet, 19" long, splash-mounted mixing faucet, 8" centers, double-joint nozzle (NOT available on 1-compartment sinks up to 22" long)	\$402.00	\$804.00
	1 ea	313296 T&S Pre-Rinse Spray, splash mount 8" centers, with wall bracket, extra heavy-duty	\$970.00	\$970.00
	1 ea	313297 T&S Add-A-Faucet, 12" spout, use with 313296 pre-rinse spray unit	\$242.00	\$242.00
	1 ea	301190 Pre-Rinse Wall Bracket	\$50.00	\$50.00

Item	Qty	Description	Sell	Sell Total
	3 ea	341189 Twist Handle Drain, 1-1/2 or 2" NPS connection NOTE: EMAIL, CUT SHEETS AND PLANS DIFFER. ITEM QUOTED PER FLOOR PLAN. VERIFY ITEM REQUIREMENTS. REV A - UPDATED FAUCET QUANTITY FROM 1 TO 2, ADDED (3) TWIST DRAIN PER EMAIL REQUEST 8/19/25.	\$162.00	\$486.00 <VERIFY>
			ITEM TOTAL:	\$13,840.00
1 ALT	1 ea	SINK, (3) THREE COMPARTMENT Eagle Group Model No. SPECFAB FN Series Sink, three compartment with apron front, 110"W x 30"D, 14/3 stainless steel top, coved corners, 15" x 26" x 15" deep compartments with twist brackets and overflow holes, hose bib bracket (hose and spray provided by others), drainboards on left & right, 10"H backsplash with 1" upturn & tile edge, (2) sets of 8" OC splash mount faucet holes, rolled edges on front & sides, includes 3-1/2" basket drains, stainless steel cross bracing on all sides, stainless steel legs & flanged feet in front, adjustable bullet feet, NSF Pot Rack, cantilever mount, 110"W x 20"D, single-bar design with tubular supports, constructed of 1/4" x 2" stainless steel flat bar, includes (24) double-pronged pot hooks, (1) 110"W x 12"D stainless steel shelf, NSF Shelf, cantilever mounted, 110"W x 12"D, rolled front edge, 1-1/2"H up-turn on sides & rear, includes stainless steel mounting brackets stud welded to shelf, 16/304 stainless steel construction, NSF	\$8,231.00	<Alternate>
	2 ea	301003 Faucet, 19" long, splash-mounted mixing faucet, 8" centers, double-joint nozzle (NOT available on 1-compartment sinks up to 22" long)	\$402.00	<Alternate>
	1 ea	313296 T&S Pre-Rinse Spray, splash mount 8" centers, with wall bracket, extra heavy-duty	\$970.00	<Alternate>
	1 ea	313297 T&S Add-A-Faucet, 12" spout, use with 313296 pre-rinse spray unit	\$242.00	<Alternate>
	1 ea	301190 Pre-Rinse Wall Bracket	\$50.00	<Alternate>
	3 ea	341189 Twist Handle Drain, 1-1/2 or 2" NPS connection NOTE: EMAIL, CUT SHEETS AND PLANS DIFFER. ITEM QUOTED PER FLOOR PLAN. VERIFY ITEM REQUIREMENTS. REV A - UPDATED FAUCET QUANTITY FROM 1 TO 2, ADDED (3) TWIST DRAINS PER EMAIL REQUEST 8/19/25.	\$162.00	<Alternate> <VERIFY> <Alternate>
			ITEM TOTAL: <Alternate>	\$10,783.00
2	1 ea	WALL FLASHING Eagle Group Model No. SPECFAB Wall Flashing, Per Square foot, 20/3 gauge stainless steel and associated trim to cover a total area of 9'-2"L x 1-1/2'H (verify dimensions required).	\$522.00	\$522.00

Item	Qty	Description	Sell	Sell Total
			ITEM TOTAL:	\$522.00
REV A - MODIFIED ITEM #'S 1 AND 1 ALT PER EMAIL REQUEST 8/19/25.				
			Total	\$14,362.00

PAYMENT TERMS

Net 30 Days with Purchase Order issued and noted on invoice.

EQUIPMENT DELIVERY

Do not sign for your delivery without inspecting it for freight damage. If there is any visible damage the best course of action is to refuse the delivery completely. Notate on the delivery receipt: "Refused Damaged" and notify us at 800-319-0690. Once we get confirmation from the carrier that the delivery was refused a replacement will be shipped to you. If you discover damage after you sign for the delivery, we will not be able to send a replacement and you will need to file a damage claim with the carrier within five (5) business days.

RETURN POLICY

There is a 25% re-stocking fee applied to all items that are refundable. Items labeled as "used," "non-stock" (specially ordered from the manufacturer), "made to order" (custom-made), or "special order" might be non-refundable or require a higher re-stocking fee, determined by the manufacturer. Products cannot be returned without prior authorization of a Mission Restaurant Supply Customer Service Representative. If for any reason you wish to return or exchange an item or your entire order, please contact us via e-mail returns@missionrs.com or toll free at 800-319-0690. To receive a credit (except for freight charges), items must be returned freight prepaid within 30 days of receiving your order, unopened, and in the same unused condition we shipped it to you. Freight is **NON-REFUNDABLE**.

DAMAGE POLICY

Inspect your shipment for any damages BEFORE signing. The delivery driver is required to wait for your thorough inspection. REFUSE the damaged shipment, notate "Refused Damaged" on the delivery receipt, and notify us at 800-319-0690. Once we get confirmation from the carrier of the refusal, a replacement will be shipped to you. Should you choose to sign for the delivery and notice damage later, it will be your responsibility to file a freight claim with the carrier. MissionRS is not responsible for the outcome of your claim.

SPECIAL ORDERS

Special Order, Made to Order (custom-made), and Non-Stock items (specially ordered from the manufacturer) are **NON-REFUNDABLE**.

STANDARD EXCLUSIONS

Plumbing and electrical hook-ups, including all indirect waste drains, back flow preventers, roof penetrations/resealing, curbs, supports, and pads are not included in this quote unless otherwise indicated.

APPLICABLE FEES

Freight and sales tax* may be applicable and may be reflected on final invoice. Processing fees may apply.

*Completed sales tax exemptions certificates must be provided to be considered exempt.

ERRORS

Mission Restaurant Supply reserves the right to correct pricing or typographical errors on this quote and refuse or cancel any order placed for said price.

REGULATED BY THE TEXAS DEPARTMENT OF LICENSING AND REGULATION, P.O. Box 12157, Austin, TX 78711. (800) 803-9202, (512) 463-6599. www.tdlr.texas.gov Texas Refrigeration Licenses #TACLB42276C, #TACLB022617R, #TACLB020056R, #TACLB26723R

Acceptance: _____ Date: _____

Printed Name: _____

Project Grand Total: \$14,362.00



Fort Bend County Fresno Boys & Girls Club
1031 W Sycamore Rd Fresno Tx

Change Order

Change Order
No. 010

RE: **Removal of Site Irrigation**

Date: 10/6/2025

Teal Job #24-1707

Item #	Description	Total	Contractor
1	Removal of Selected Irrigation	-\$7,958.97	
2			
	Subcontractor Subtotal	(\$7,958.97)	
	Project Schedule - Impacts/Delays	0	
	Current Substantial Completion Date: 6/15/2025	No. of Days of Schedule Impact: 116 Days	Revised Substantial Completion: 10/27/2025
	Summary		
	Sub Total	-\$7,958.97	
	Project Schedule Days Added (Calendar)	0	
	General Conditions (5%)	-\$397.95	
	Insurance (3%)	-\$238.77	
	Fee (5%)	-\$397.95	
	Grand Total	-\$8,993.64	
		Date: 10/6/2025	
	Michael Krause - PM - Teal Construction		

REVISED

RFC No 03

Date: 09-18-2025

To: Teal Construction

Attention: Michael Krause

Email: michaelkrause@tealcon.com

Sarah Bottlinger
 #512.848.7871
 E: sarahb@choateusa.com

Project Title & Location

Fresno Community Center
 1031 W. Sycamore Road
 Fresno, Texas 77545

Sheet Numbers

L11.01

Date

02-29-2024

Specifications: Per plan sheets listed above

Addendum: N/A

Estimator/Job ID: JSK/VID12881

Project Completion to be performed as Indicated for Sum(s) Described:

Scope of Work

Note: See Qualifications and Materials List below

Irrigation: Blue Area

Inclusions:

- *Irrigation changes to the area shown in blue on the Exhibit below.*
- *Credit back for the removal of permanent irrigation consisting of the following: (8x) 1-1/2" Valves with associated wires, (5x) Quick Couplers, (2x) 2" Ball Valve, (6x) Tree Bubblers, (59x) Rotors, (1,022 lf) 2" Mainline, (8 lf) Class 200 PVC 4" Sleeve and all associated fittings.*

Exclusions:

- *Any work outside the scope specifically called out above.*
- *Any landscape changes.*
- *Warranty for plants and plant material within the blue area on the Exhibit below.*

	Labor	\$ 3,997.16	Init.
	Materials	\$ 9,249.28	Init.
	Total Irrigation Change (Deduct)	\$ 13,246.44	Init.

Irrigation: Blue Area

Inclusions:

- *Irrigation changes to the area shown in blue on the Exhibit below.*
- *Additional 44,820 sf of Temporary Irrigation to establish hydroseed within the area in blue on the Exhibit below.*

Exclusions:

- *Any work outside the scope specifically called out above.*

- Any landscape changes.
- Warranty for plants and plant material within the blue area on the Exhibit below.

Labor	\$	4,573.89	Init.
Materials	\$	3,361.50	Init.
Total Irrigation Change (Add)	\$	7,935.39	Init.

Irrigation: Red Area

Inclusions:

- Irrigation changes to the area shown in red on the Exhibit below.
- Credit back for the removal of permanent irrigation consisting of the following:
 (1x) 1-1/2" Valves with associated wires, (15x) Rotors and all associated fittings.

Exclusions:

- Any work outside the scope specifically called out above.
- Any landscape changes.
- Warranty for plants and plant material within the red area on the Exhibit below.

Labor	\$	364.47	Init.
Materials	\$	1,155.74	Init.
Total Irrigation Change (Deduct)	\$	1,520.21	Init.

Irrigation: Orange Area

Inclusions:

- Irrigation changes to the area shown in orange on the Exhibit below.
- Credit back for the removal of permanent irrigation consisting of the following:
 (1x) Quick Couplers, (10x) Rotors and all associated fittings.

Exclusions:

- Any work outside the scope specifically called out above.
- Any landscape changes.
- Warranty for plants and plant material within the orange area on the Exhibit below.

Labor	\$	234.16	Init.
Materials	\$	893.54	Init.
Total Irrigation Change (Deduct)	\$	1,127.71	Init.

Exhibit:

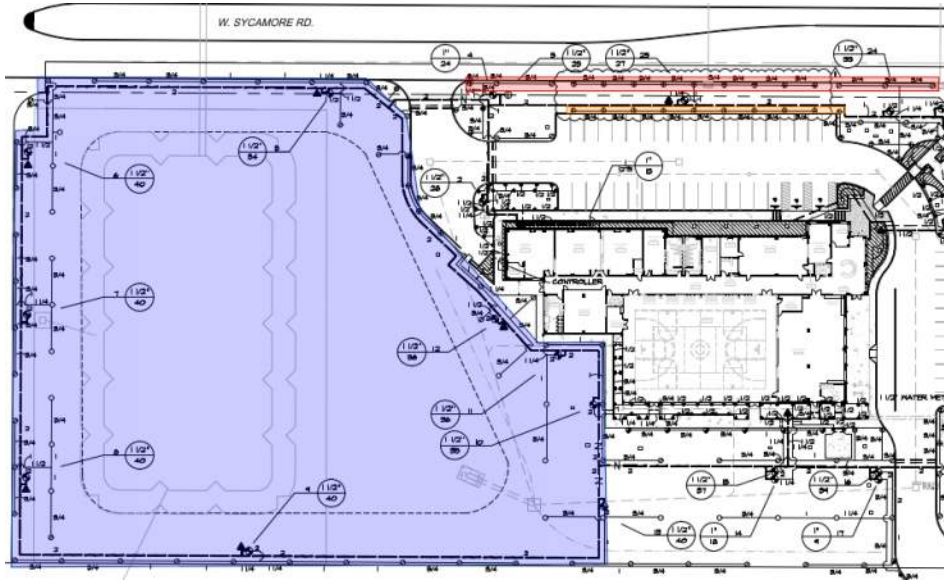

PAYMENT / PAYMENT SCHEDULE

Draw Schedule/Payments [and Retainage, if required] shall be Net 30 unless otherwise determined and agreed upon, **in writing, prior** to commencement of any work on the proposed/contracted irrigation installation site.

Contractor shall be notified of any contemplated contractor back charge, **in writing at least 7 days prior** to the back charge event. Contractor shall be given the opportunity to investigate and confirm or refute any impending or contemplated back charge before it occurs.

All monies are due at time of Final Acceptance. Written evidence of acceptance by the contractor and/or agents of contractor is signified by completion of Contractor's Acceptance Form.

Request for Change (RFC) is not considered accepted unless all appropriate initials and signatures are applied where indicated.

By: _____ Accepted By: _____
 Date Date

Title: Contract Administrator, Choate USA Printed Name/Title: _____

Irrigation in Texas is regulated by the
 Texas Commission on Environmental Quality (TCEQ) (MC-235)
 P.O. BOX 13087, Austin, Texas 78711-3087
 TCEQ's website is: www.tceq.texas.gov.

Filename: Document1 - Printed on: 9/18/2025

IMPORTANT NOTICE: You and your contractor are responsible for meeting the terms and conditions of this contract. If you sign this contract and you fail to meet the terms and conditions of this contract, you may lose your legal ownership rights to your home. KNOW YOUR RIGHTS AND DUTIES UNDER THE LAW.



Fort Bend County Fresno Boys & Girls Club
 1031 W Sycamore Rd Fresno Tx

Change Order

Change Order
No. 011

RE: **Site Light Pole Foundations**
 Date: 10/6/2025

Teal Job #24-1707

Item #	Description	Total	Contractor
1	Site Light Pole Foundations	\$6,166.89	
2			
	Subcontractor Subtotal	\$6,166.89	
	Project Schedule - Impacts/Delays	0	
	Current Substantial Completion Date:	6/15/2025	No. of Days of Schedule Impact: 116 Days
			Revised Substantial Completion: 10/27/2025
	Summary		
	Sub Total	\$6,166.89	
	Project Schedule Days Added (Calendar)	0	
	General Conditions (5%)	\$308.34	
	Insurance (3%)	\$185.01	
	Fee (5%)	\$308.34	
	Grand Total	\$6,968.59	
		Date: 10/6/2025	
	Michael Krause - PM - Teal Construction		

PROJECT: FRESNO COMMUNITY CENTER: CO-2 EXTRA LIGHT POLES

REFERENCE: 240404-01

PRESENTED TO: Michael Krause / Tuan Nguyen / TEAL CONSTRUCTION

DATE: 9/29/2025

PRESENTED BY: Agustin Serrato, President, A. S. Builders

CHANGE ORDER: **2**

IT	QTY	DESCRIPTION	QUANTITY (APPROX)	UNIT	UNIT PRICE	SUBTOTAL
A) CHANGE ORDER DESCRIPTION						
1		NEW LIGHT POLE BASES • 18" D x 5'+2.5' HT / 6#5 V + #3@12" OC + #3@3" OC anch bolts Ties / 3000 PSI	6	EA	\$ 1,027.82	\$ 6,166.89
		LABOR: Tie rebar, pouring, finishing, concrete works.	6	EA	\$ 282.50	\$ 1,695.00
		MATERIALS: Concrete, Rebar, Forms,sonotubes, braces, etc.	6	EA	\$ 188.58	\$ 1,131.47
		EQUIPMENT: Driller, auger,	6	EA	\$ 463.30	\$ 2,779.80
		ASB MARKUP:	10%			\$ 560.63

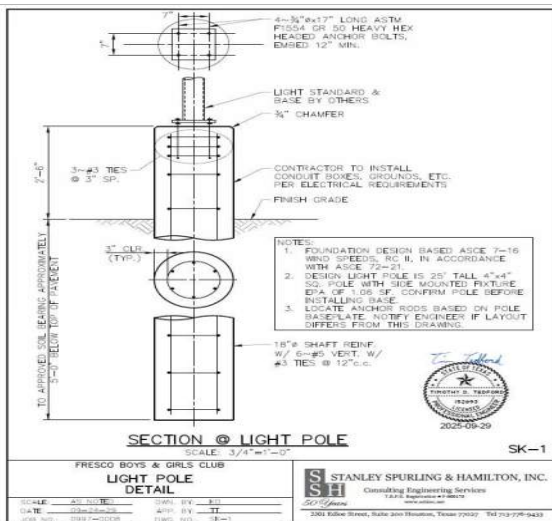

PLEASE SEE TAKE OFF LAYOUT FILES

TOTAL PROPOSAL:

\$ 6,166.89

- PLANS:**
- Architecture set by Stern & Bucek Arch / David C Bucek labeled "ISSUE FOR PERMIT" and dated 10/31/2022.
 - Civil set by Walter P Moore Assoc. / Tabish Shiddiqui not labeled and dated 10/27/2023
 - Structural set by Walter P Moore Assoc. / Shruti Sharma not labeled and dated 10/27/2023
 - Landscape set by OJB / James D Burnett labeled "ISSUE FOR PERMIT" and dated 10/27/2022.

- NOTES:**
- 1 Due actual market conditions prices could require revision after 30 days or after a big price change.
 - 2 We are not covering underground facilities damages.
 - 3 We are not covering any damage to Landscape, Trees and or installations adjacent to work areas and needed for our normal scope of work. Any repair will need a separate pricing and approval from Customer
 - 4 We are not providing any paint, striping, traffic markings, electrical work, etc.
 - 5 We are not including Demolition Works (U.N.O.)
 - 6 We are not covering any joints sealing: will require separate pricing per method requested.
 - 7 We are not including dirt and or earth movement works, hauling and excavations (U.N.O.)
 - 8 We are not including Plumbing, Electrical, Landscape or Mechanical trench works.
 - 9 We are not including overnight / weekend hours.
 - 10 We are not including extra mobilizations (\$4,500.00)
 - 11 Prices may need updates due sudden market changes.
 - 12 We are not including rubber Speed Bumps.
 - 13 We are not including Cranes or Hoisting Equipment
 - 14 We are not including any Permit Fee or Inspections.

Agustin
Serrato
PRESIDENT

ACCEPTED BY:

DATE:

SIGNATURE:

POSITION: